

Copeland[™]
brand products

Alco Controls[™]

General Product Guide 2015

For Refrigeration, Air Conditioning and Heat Pumps



EMERSON[™]
Climate Technologies



Copeland™
brand products

Alco Controls™

Copeland Scroll®

Copeland Scroll®

Digital

Copeland Scroll®

Heating

Copeland Scroll®

Variable Speed

DWM COPELAND

Copeland®
EazyCool®

Note:

The components listed in this catalogue are not released for use with caustic, poisonous or flammable substances. Emerson Climate Technologies cannot be held responsible for any damage caused by using these substances.

General Information

Technical data provided herein is collected with scrutiny. However, errors and misprinting remain reserved. The technical data is presented for informational purposes only and they are not to be construed as warranties or guarantees, express or implied, regarding the products or services described or their use or applicability.

Technical data may be updated; should you require confirmation with respect to a specific value, please contact Emerson Climate Technologies GmbH and clearly state the information you require.

Emerson Climate Technologies GmbH and/or its affiliates (collectively “Emerson”) shall not be liable for errors in the stated capacities, dimensions, etc., as well as typographic errors. Products, specifications, designs and technical data contained in this document are subject to modification by us without prior notice. Illustrations are not binding.

Emerson does not assume responsibility for the selection, use or maintenance of any product. Responsibility for proper selection, use and maintenance of any product remains solely with the purchaser and end-user.

The information given herein is based on data and tests which Emerson Climate Technologies GmbH believes to be reliable. Such information is intended for use by individuals having the appropriate technical knowledge and skills, at their own discretion and risk. Our products are designed and adapted for stationary application. When using our products in mobile applications, our products might fail. The suitability for such mobile applications has to be assured by the plant manufacturer; for this purpose appropriate tests might be necessary.

Scroll Compressors

- Comfort

• ZR Copeland Scroll™ Compressor Range for R407C and R134a	10
• ZP Copeland Scroll™ Compressor Range for R410A	14
• ZPD & ZRD Copeland Scroll Digital™ Compressor Range for R410A and R407C	18
• ZPV Copeland Scroll™ Variable Speed Compressor Range for R410A	22
• ZH Copeland Scroll™ Fixed Speed Compressor Range for R410A and R407C	24
• ZHV & ZHW Copeland Scroll™ Variable Speed Compressor Range for R410A	28
• ZH Copeland Scroll™ For Heat Recovery and High Condensing Applications for R134a	30
• ZRH Copeland Scroll™ Horizontal Compressor Range	32

- Refrigeration

• ZB Copeland Scroll™ Compressor Range for Medium Temperature Refrigeration	36
• ZF Copeland Scroll™ Compressor Range for Low Temperature Refrigeration	44
• ZFD & ZBD Copeland Scroll Digital™ Compressor Range for Medium and Low Temperature Refrigeration	50
• ZO & ZOD Copeland Scroll™ Compressor Range for CO ₂ -Subcritical Refrigeration	56
• Sound Shell for Copeland Scroll™ Compressors	58
• Scroll Booster Compressor	60

Semi-Hermetic Reciprocating Compressors

- K and L Reciprocating Compressor Range	64
- Discus™ Reciprocating Compressor Range	68
- Discus™ Digital (3Cylinder) Reciprocating Compressor	74
- Copeland™ Stream with CoreSense™ Diagnostics, Semi-Hermetic Reciprocating Compressors For HFC	78
- Copeland™ Stream Digital with CoreSense™ Diagnostics for Continuous Capacity Modulation	86
- Copeland™ Stream Compressors with CoreSense™ Diagnostics for R744-Transcritical Applications	92
- Copeland™ Stream Compressors with CoreSense™ Diagnostics for R744-Subcritical Applications	94
- S-Series Reciprocating Compressor Range	96
- Service Compressors for 4 and 6 cylinder S-Series and Discus Reciprocating Compressors	97

Condensing Units

- Copeland EazyCool™ Outdoor Condensing Units with Scroll Compressors	100
- Copeland EazyCool™ Outdoor Condensing Units for Refrigeration Networks	106
- Copeland EazyCool™ ZX Outdoor Condensing Units with Scroll Compressors	110
- Copeland Scroll™ Indoor Condensing Units for Refrigeration	114
- Copeland Scroll™ Digital Receiver Unit HLR	124
- Semi-Hermetic Condensing Units DK/DL	128
- Condensing Units with Semi-Hermetic Discus™ Compressors	132
- Condensing Units with Semi-Hermetic Stream Compressors and CoreSense™ Diagnostics	136

Compressor Motor Codes Table

140

Controls

- Electrical Control Valves	147
- Electronic Controllers and Sensors	175
- Thermo™-Expansion Valves	207
- Solenoid Valves	239
- Mechanical Pressure Regulators	251
- Pressure Controls and Thermostats	259
- System Protectors and Moisture Indicators	279
- Oil Management Components	299
- Suction Accumulators, Ball Valves and Oil Test Kit	313
- Accessories & Spare Parts	317
- Alco Keyword Register	326

Pioneering Technologies For Best-In-Class Products

Emerson Climate Technologies is the world's leading provider of heating, ventilation, air conditioning and refrigeration solutions for residential, commercial and industrial applications. We create reliable, energy-efficient climate systems that improve human comfort, safeguard food, and protect the environment.

For more than 80 years we have been introducing innovative technology to the market, from the first semi-hermetic and hermetic compressors in the 1940s and 1950s, over the high efficiency Discus, air conditioning and heating scroll compressors in the 1980s and 1990s, to the new Stream semi-hermetic compressors, the digital scroll compressor and the variable speed scroll with drive technology of today.

Based on this, we have developed an unequalled range of solutions for the refrigeration and air conditioning markets. In recent years, we have become a major solutions provider to the heat pump industry. Our range of Copeland™ brand compressors is engineered for higher efficiency, lower sound levels, superior durability and unsurpassed reliability. They allow the integration of new and environmentally-friendly refrigerants into your systems, while seamlessly improving efficiency and performance levels. Alco Controls™ is the leading provider of precision mechanical controls for the refrigeration and air conditioning markets, and together with the range electronic controls from Emerson Climate Technologies we continue to pioneer the control of refrigerant flow with innovative design, keeping system performance optimization central to our product development.

1,300 employees develop and deliver Emerson's high-class technology and manufacture our products in four European plants: Belgium, Northern Ireland and the Czech Republic (two plants). R&D centers in Welkenraedt (Belgium) and Mikulov (Czech Republic) enable new developments not only to meet our customers' requirements, but also to redefine the limits of technology.

With sales offices in Germany, France, Spain, Italy, the United Kingdom, Scandinavia, Benelux, Poland, as well as in Eastern Europe and Russia, Emerson Climate Technologies supports its European customers in a lean and efficient manner, supporting the industry with advanced technology, technical support and training services.

Our 2015 product catalogue gives a comprehensive overview of Emerson Climate Technologies', Copeland brand and Alco Controls products. Take a look and discover our broad product ranges including these new innovations:

- The commercial variable speed scrolls inverter drive for superior performance when designing reversible chillers, heat pumps, precision cooling systems or rooftops
- The ZH*KCE scrolls for R134a for the recovery and reuse of heat generated by production processes or machining cooling equipment
- Four ZB*K5 Summit scrolls for medium temperature applications designed for improved efficiency,
- The Scroll Digital ZBD*K5 models dedicated to medium temperature applications ensuring a perfect match of capacity and power to the desired load
- The Extended 4-cylinder Stream compressor range for R744 transcritical applications and new 4-cylinder Stream compressor platform for R744 subcritical applications
- Stream condensing units: long engineering and manufacturing experience combined with the introduction of innovative system intelligence now unleash new opportunities in low-, medium- and high-temperature applications,
- The OM5 and OW5 oil level management and monitoring for high-pressure transcritical CO₂ applications,
- The LW4 / LW5 Level Watch series to monitor oil and liquid refrigerant levels in vessels for high-pressure applications
- The EXD-U Controller, specifically designed for Emerson EX and CX electrical control valves in high-pressure CO₂ / high MOPD applications.
- The extended series of solenoid valves for high-pressure applications and a line of high-wattage coils for solenoid valves and the OM series of oil level management systems.

More in-depth technical data is available through our user-friendly Copeland and Alco selection software tools accessible via our web page www.emersonclimate.eu. For individual consultancy and service please contact your European sales office.



Copeland Scroll™ Compressors

With the launch of scroll technology in the mid 1980s, Emerson revolutionized the market setting new standards in the air conditioning industry. Since then, Copeland Scroll has become the reference not only in air conditioning but in refrigeration and heating applications too. Thousands of customers trust our proprietary technology: today, over 80 million Copeland Scrolls are installed worldwide, more than any other scroll compressor brand. Copeland Scroll compressors range from 1.5 to 60 hp and are designed to work with all the main refrigerants, including CO₂. With compressors built in both vertical and horizontal versions and capable of digital modulation, Emerson Climate Technologies has expanded the capability of scroll technology to new heights.

Additional innovations such as Enhanced Vapor Injection, the new Variable Speed scroll with drive technology for heat pump compressors or the design of the Emerson Climate Technologies sound shell give manufacturers, installers and end users the right tools to reduce the carbon footprint of their installations, optimize system design, efficiency, sound and reliability, while ensuring long equipment lifetime and minimizing capital and operating costs.

Applications for scroll compressors continue to grow thanks to innovation and adaptation. Industry as a whole has embraced its responsibility to put the environment first in its list of priorities, and this has led to strategic imperatives such as the need to introduce larger capacity scrolls with improved seasonal performance, modulated systems and product designed for use with “green” refrigerants such as CO₂. Emerson Climate Technologies is staying abreast of these challenges by successfully further developing its technologies in each of these areas.



Today we offer the broadest scroll product line-up in the market



Comfort Applications

For decades, Emerson Climate Technologies has driven advancement in the air conditioning and heat pump industry, leading the field with engineering products and systems that maximize the comfort of office and living spaces – while minimizing costs and inefficiencies.

Copeland Scroll™ compressors are designed to deliver the highest performance in residential and commercial applications. Thanks to the widest selection of air conditioning and heating optimized scroll compressors with a range from 1.5 up to 60 hp and the option to combine single compressors in even and uneven tandem and trio versions increasing overall capacity up to 180 hp per circuit, it has never been easier to match all desired applications with the highest efficiency and reliability. Whether your need is a cooling optimized, heating optimized or reversible unit, you will find the most advanced technology within our range.

One of the most important recent introductions for comfort applications has been the launch of the ZPV Variable Speed scroll compressors for commercial applications. They allow system manufacturers and building owners to achieve superior performance when designing reversible chillers, heat pumps, precision cooling systems or rooftops. This technology was first introduced as a solution for residential heat pump applications (ZHW) and was later extended to reversible and low temperature applications, with the introduction of the ZHV and ZPV R410A Variable Speed Scrolls.

A further innovation has been the introduction of the ZH*KCE scrolls for R134a. These compressors were developed for the recovery and reuse of heat generated by production processes or machining cooling equipment and can contribute to reducing energy costs.

ZR Copeland Scroll™ Compressor Range for R407C and R134a

ZR Copeland Scroll compressors, for R407C and R134a, for comfort and process/precision cooling applications.

Applied in the air conditioning and comfort industry for water chillers, rooftops and close control unit applications, scroll compressors are now the most used compression technology replacing reciprocating and screw compressors due to its undeniable superiority. Several, fully Copeland™ qualified, multiple compressor assemblies (tandem and trio) are available to allow the use of Copeland Scroll compressors into large capacity systems (ex. up to 500kW air cooled chillers) able to deliver optimal comfort, low operating cost with higher seasonal efficiency (ESEER).

The range of products goes from the ZR18 (1.5Hp) to the ZR380 (30hp)



ZR Scroll Compressor

ZR Scroll Compressor Line-up R407C

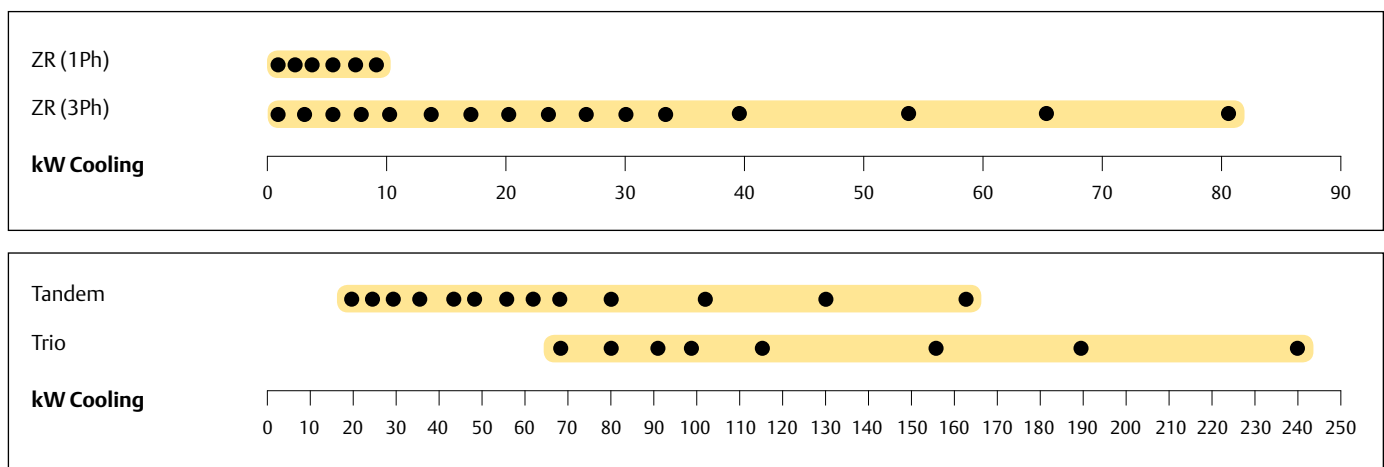

Conditions EN12900: Evaporating 5°C, Condensing 50°C, Superheat 10K, Subcooling 0K

Features and Benefits

- Copeland Scroll axial and radial compliance for superior reliability and efficiency
- Wide scroll line-up for R407C and R134a
- Low TEWI (Total Equivalent Warming Impact)
- Low sound and vibration level
- Low oil circulation rate
- Copeland qualified tandem and trio configurations for superior seasonal efficiency (ESEER)

Maximum Allowable Pressure (PS)

- ZR18 to ZR81:
Low Side PS 20 bar(g) / High Side PS 29.5 bar(g)
- ZR94 to ZR380:
Low Side PS 20 bar(g) / High Side PS 32 bar(g)

Operating Envelope R407C

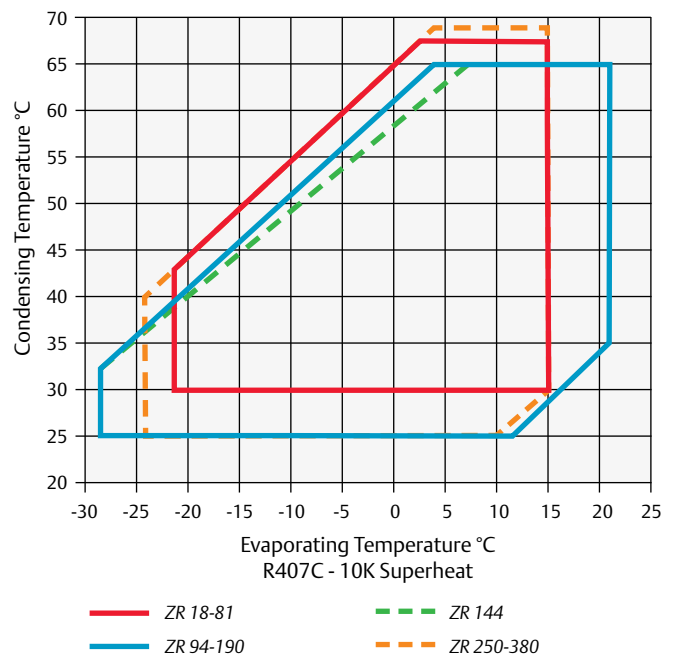

Technical Overview

Models	Nominal hp	Capacity (kW)	COP	Displacement (m ³ /h)	Stub Suction (inch)	Stub Discharge (inch)	Oil Quantity (l)	Length/Width/Height (mm)	Net Weight (kg)	Motor Version/ Code		Maximum Operating Current (A)		Locked Rotor Current (A)		Sound Pressure @1 m (dBA) ***
										1 Ph*	3 Ph**	1 Ph*	3 Ph**	1 Ph*	3 Ph**	
ZR18K3E	1.5	3.7	3.0	4.4	¾	½	0.74	242/242/383	20	PFJ		10		35		54
ZR22K3E	2.0	4.5	2.9	5.3	¾	½	1.00	242/242/363	22	PFJ	TFD	11	4	47	24	54
ZR28K3E	2.5	5.9	2.9	6.8	¾	½	1.00	242/242/363	25	PFJ	TFD	15	5	61	32	54
ZR34K3E	2.8	7.0	3.0	8.0	¾	½	1.10	242/242/386	26	PFJ	TFD	17	6	76	40	57
ZR40K3E	3.5	8.2	3.0	9.4	¾	½	1.10	242/242/400	27	PFJ	TFD	23	7	100	46	57
ZR48K3E	4.0	10.1	3.1	11.4	¾	½	1.36	242/242/417	31	PFJ	TFD	23	10	114	50	57
ZR61KCE	5.0	12.5	3.1	14.4	¾	½	1.66	241/247/451	43	PFJ	TFD	30	11	150	65	60
ZR61K3E	5.0	12.8	3.2	14.4	¾	½	1.42	242/242/430	30	PFZ	TFM		11		59	61
ZR72KCE	6.0	14.8	3.2	17.1	¾	½	1.77	242/242/438	39		TFD		13		74	61
ZR81KCE	6.8	16.7	3.2	18.7	¾	¾	1.77	242/242/446	39		TFD		15		101	61
ZR94KCE	8.0	20.6	3.3	22.1	1 ¼	¾	2.65	264/285/476	57		TFD		16		95	63
ZR108KCE	9.0	23.0	3.4	24.9	1 ¼	¾	3.38	264/285/533	60		TFD		17		111	63
ZR125KCE	10.0	27.0	3.4	29.1	1 ¼	¾	3.38	264/285/533	61		TFD		19		118	63
ZR144KCE	12.0	30.9	3.4	33.2	1 ¼	¾	3.38	264/285/533	61		TFD		22		118	64
ZR160KCE	13.0	33.4	3.2	36.4	1 ¼	¾	3.38	264/285/552	65		TFD		28		140	67
ZR190KCE	15.0	39.3	3.2	43.3	1 ¼	¾	3.38	264/285/552	66		TFD		34		174	69
ZR250KCE	20.0	52.2	3.2	56.6	1 ¼	1 ¼	4.70	432/376/717	140		TWD		41		225	72
ZR310KCE	25.0	65.0	3.2	71.4	1 ¼	1 ¼	6.80	448/392/715	160		TWD		52		272	74
ZR380KCE	30.0	81.7	3.4	87.4	1 ¼	1 ¼	6.30	447/427/724	177		TWD		62		310	76

Conditions EN12900 : Evaporating 5°C, Condensing 50°C, Superheat 10K, Subcooling 0K

* 1 Ph: 230V/ 50Hz

** 3 Ph: 380-420V/ 50Hz

*** @ 1m: sound pressure level at 1m distance from the compressor, free field condition

Capacity Data

Condensing Temperature +40°C															
R134a	Cooling Capacity (kW)							R134a	Power Input (kW)						
	Evaporating Temperature (°C)								Evaporating Temperature (°C)						
Model	-15	-10	-5	0	+5	+10	+15	Model	-15	-10	-5	0	+5	+10	+15
ZR22K3E	1.4	1.8	2.3	2.9	3.6	4.4	5.3	ZR22K3E	0.9	0.9	0.9	0.9	0.9	0.8	0.8
ZR28K3E	1.8	2.3	3.0	3.8	4.7	5.7	6.9	ZR28K3E	1.1	1.2	1.1	1.1	1.1	1.1	1.1
ZR34K3E	2.2	2.9	3.6	4.5	5.5	6.7	8.1	ZR34K3E	1.4	1.4	1.4	1.3	1.3	1.3	1.3
ZR40K3E	2.5	3.3	4.2	5.2	6.4	7.8	9.3	ZR40K3E	1.6	1.5	1.5	1.5	1.5	1.5	1.5
ZR48K3E	3.1	4.0	5.1	6.3	7.8	9.5	11.5	ZR48K3E	1.8	1.8	1.8	1.8	1.8	1.8	1.8
ZR61KCE	4.0	5.2	6.5	8.1	9.9	12.1	14.6	ZR61KCE	2.1	2.1	2.2	2.2	2.2	2.2	2.3
ZR72KCE	4.8	6.2	7.8	9.7	11.9	14.5	17.4	ZR72KCE	2.6	2.6	2.6	2.6	2.6	2.6	2.7
ZR81KCE	5.5	7.0	8.8	10.8	13.2	16.0	19.2	ZR81KCE	2.8	2.9	2.9	2.9	2.9	3.0	3.0
ZR94KCE	6.5	8.3	10.5	13.0	15.9	19.2	23.0	ZR94KCE	3.4	3.4	3.4	3.5	3.5	3.5	3.5
ZR108KCE	7.3	9.3	11.7	14.5	17.8	21.5	25.7	ZR108KCE	3.7	3.8	3.8	3.9	3.9	3.9	3.9
ZR125KCE	8.6	10.9	13.7	17.0	20.8	25.1	30.0	ZR125KCE	4.4	4.4	4.5	4.5	4.6	4.6	4.5
ZR144KCE	10.5	13.4	16.5	20.0	23.7	27.8	32.4	ZR144KCE	4.7	4.9	4.9	5.0	5.0	5.2	5.5
ZR160KCE	11.0	14.3	17.7	21.4	25.5	30.1	35.3	ZR160KCE	5.4	5.4	5.5	5.6	5.7	5.7	5.6
ZR190KCE	13.3	17.0	21.0	25.5	30.5	36.2	42.7	ZR190KCE	6.5	6.6	6.7	6.8	6.8	6.9	7.0
ZR250KCE	16.6	21.0	26.3	32.5	39.7	48.2	57.9	ZR250KCE	8.8	8.8	8.9	9.0	9.1	9.2	9.4
ZR310KCE	20.5	26.0	32.5	40.1	49.1	59.6	71.7	ZR310KCE	11.0	11.0	11.1	11.2	11.3	11.5	11.7
ZR380KCE	26.0	32.9	41.1	50.8	61.8	74.4	88.6	ZR380KCE	13.0	13.3	13.5	13.8	13.9	14.1	14.2

Conditions: Suction Superheat 10K / Subcooling 0K

Condensing Temperature +40°C															
R407C	Cooling Capacity (kW)							R407C	Power Input (kW)						
	Evaporating Temperature (°C)								Evaporating Temperature (°C)						
Model	-15	-10	-5	0	+5	+10	+15	Model	-15	-10	-5	0	+5	+10	+15
ZR18K5E	1.8	2.3	2.8	3.5	4.2	5.1	6.1	ZR18K5E	1.0	1.0	1.0	1.0	1.0	1.0	1.0
ZR22K3E	2.1	2.7	3.4	4.2	5.2	6.3	7.5	ZR22K3E	1.2	1.2	1.2	1.2	1.2	1.2	1.1
ZR28K3E	2.7	3.5	4.4	5.5	6.7	8.1	9.6	ZR28K3E	1.6	1.6	1.6	1.5	1.5	1.5	1.5
ZR34K3E	3.2	4.1	5.2	6.5	7.9	9.6	11.5	ZR34K3E	1.8	1.8	1.8	1.8	1.8	1.8	1.7
ZR40K3E	3.8	4.9	6.1	7.6	9.4	11.3	13.5	ZR40K3E	2.2	2.2	2.2	2.1	2.1	2.1	2.0
ZR48K3E	4.8	6.1	7.6	9.4	11.5	13.8	16.6	ZR48K3E	2.6	2.6	2.6	2.6	2.6	2.5	2.5
ZR61KCE	6.5	8.1	10.0	12.0	14.4	17.2	20.6	ZR61KCE	3.0	3.1	3.1	3.2	3.2	3.1	2.9
ZR72KCE	7.0	9.0	11.3	13.9	16.9	20.3	24.2	ZR72KCE	3.6	3.7	3.7	3.7	3.7	3.7	3.8
ZR81KCE	7.8	10.1	12.7	15.6	19.1	23.0	27.7	ZR81KCE	4.1	4.1	4.1	4.1	4.2	4.2	4.3
ZR94KCE	9.8	12.6	15.8	19.3	23.3	27.9	33.1	ZR94KCE	4.9	5.0	5.0	5.0	5.0	4.9	4.9
ZR108KCE	11.3	14.2	17.6	21.5	26.2	31.5	37.6	ZR108KCE	5.4	5.4	5.5	5.5	5.5	5.6	5.7
ZR125KCE	13.1	16.6	20.5	25.2	30.5	36.7	43.7	ZR125KCE	6.3	6.3	6.4	6.4	6.4	6.5	6.6
ZR144KCE	14.5	18.7	23.4	28.9	35.0	42.0	50.1	ZR144KCE	7.1	7.1	7.2	7.2	7.3	7.3	7.4
ZR160KCE	14.9	19.5	24.9	31.3	38.7	47.3	57.1	ZR160KCE	8.0	8.1	8.2	8.2	8.3	8.4	8.5
ZR190KCE	18.5	23.8	29.8	36.7	44.7	53.8	64.2	ZR190KCE	9.7	9.7	9.8	9.8	9.9	10.1	10.4
ZR250KCE	25.7	32.2	39.9	48.9	59.3	71.3	85.0	ZR250KCE	12.5	12.6	12.7	12.9	13.0	13.0	13.0
ZR310KCE	31.2	39.7	49.7	61.4	75.0	90.7	108.5	ZR310KCE	15.6	15.7	15.9	16.1	16.3	16.6	17.0
ZR380KCE	38.1	49.1	61.7	76.2	93.1	113.0	136.5	ZR380KCE	18.6	18.8	19.0	19.2	19.4	19.8	20.3

Conditions: Suction Superheat 10K / Subcooling 0K

Tandem and Trio Model Overview

Model	Nominal hp	Cooling Capacity R407C (kW)	Cooling Capacity R134a (kW)	Even Tandem	Uneven Tandem	Trio
Tandem ZRT - Tandem Uneven ZRU - Trio ZRY						
ZRT 96 K3E	2 x 4	20	14	•		
ZRT 122 K3E	2 x 5	25	18	•		
ZRT 144 K3E	2 x 6	30	21	•		
ZRT 162 K3E	2 x 6.5	33	24	•		
ZRT 188 K3E	2 x 8	41	28	•		
ZRT 216 K3E	2 x 9	46	31	•		
ZRT 250 K3E	2 x 10	52	37	•		
ZRT 288 K3E	2 x 12	59	42	•		
ZRU 315 KCE*	10 + 15	66	45		•	
ZRT 320 K3E	2 x 13	67	46	•		
ZRU 350 KCE*	13 + 15	73	50		•	
ZRT 380 K3E	2 x 15	78	54	•		
ZRU 440 KCE*	15 + 20	92	63		•	
ZRY 480 KCE*	3 x 13	99	67			•
ZRT 500 K3E*	2 x 20	104	71	•		
ZRU 500 KCE*	15 + 25	104	71		•	
ZRU 560 KCE*	20 + 25	117	79		•	
ZRY 570 KCE*	3 x 15	116	80			•
ZRT 620 K3E*	2 x 25	130	88	•		
ZRU 690 KCE*	25 + 30	147	99		•	
ZRY 750 KCE*	3 x 20	154	105			•
ZRT 760 K3E*	2 x 30	163	111	•		
ZRY 930 KCE*	3 x 25	192	129			•
ZRY 114 KCE*	3 x 30	241	164			•

Conditions EN 12900: Evaporating 5°C, Condensing 50°C, Superheat 10K, Subcooling 0K

* Tandem / Trio assemblies by system manufacturers. Emerson Climate Technologies can provide full technical support.

ZP Copeland Scroll™ Compressor Range for R410A

ZP Copeland Scroll compressors, for R410A, for comfort and process/precision cooling applications. Emerson Climate Technologies has been the pioneer in launching the first complete line-up of R410A commercial scroll compressors.

ZP Copeland Scroll compressors are perfectly suitable for air-cooled chiller systems up to 900kW (1100 kW if water-cooled) featuring high comfort and superior seasonal efficiency (ESEER). Whether used in stand-alone, tandem or trio configurations, the broad ZP Copeland Scroll line-up meets today's market requirements with unmatched flexibility, efficiency and proven reliability.

The new ZP104KCE and ZP122KCE compressors for light commercial systems have a reduced footprint and weight for more compact systems. Their high efficiency helps to reduce operating costs.



ZP Scroll Compressor

ZP Scroll Compressor Line-up

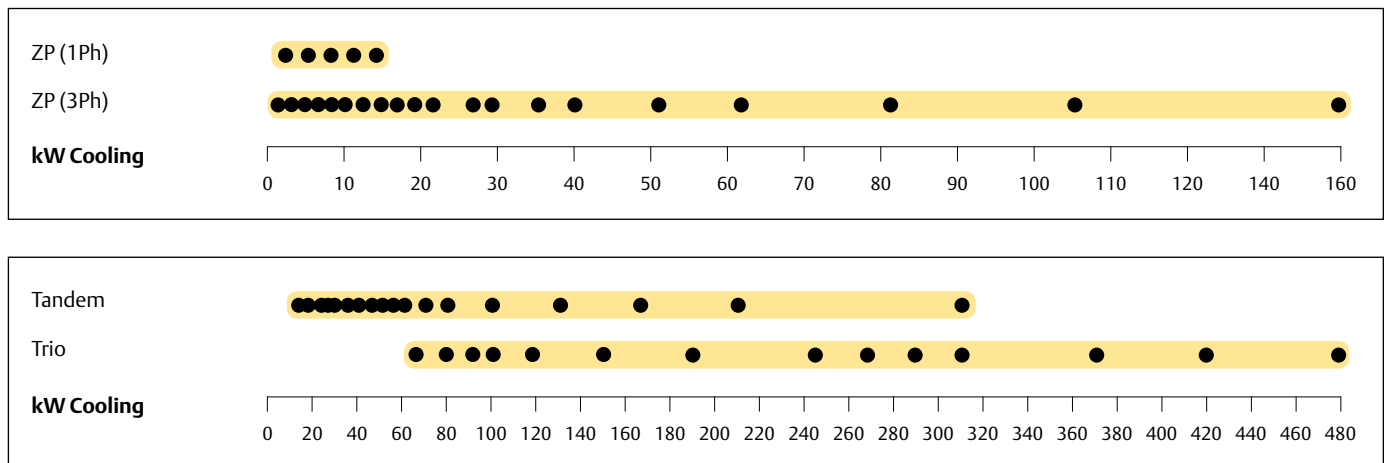

Conditions EN12900: Evaporating 5°C, Condensing 50°C, Superheat 10K, Subcooling 0K

Features and Benefits

- Copeland qualified tandem and trio (now also uneven) configurations for superior seasonal efficiency (ESEER and SCOP)
- Copeland Scroll axial and radial compliance for superior reliability and efficiency
- Extended 5K operating envelope suitable for HP applications
- Low TEWI (Total Equivalent Warming Impact)
- Wide scroll line-up for R410A
- Low sound and vibration level
- Low oil circulation rate

Maximum Allowable Pressure (PS)

- ZP24 to ZP91:
Low Side PS 28 bar(g) / High Side PS 43 bar(g)
- ZP104 to ZP725:
Low Side PS 29.5 bar(g) / High Side PS 45 bar(g)

Operating Envelope R410A

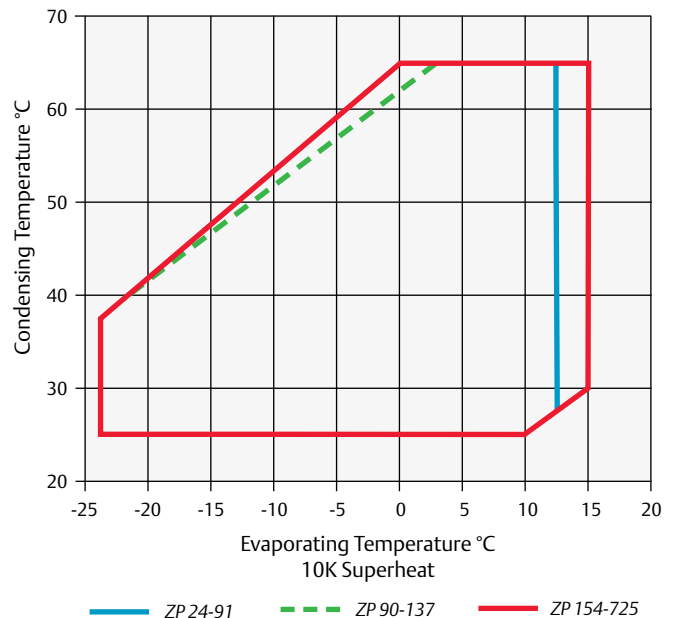

Technical Overview

Models	Nominal hp	Capacity (kW)	COP	Displacement (m ³ /h)	Stub Suction (inch)	Stub Discharge (inch)	Oil Quantity (l)	Length/Width/Height (mm)	Net Weight (kg)	Motor Version/Code		Maximum Operating Current (A)		Locked Rotor Current (A)		Sound Pressure @ 1 m (dBA) ***
										1 Ph*	3 Ph**	1 Ph*	3 Ph**	1 Ph*	3 Ph**	
ZP24KSE	1.9	5.1	2.8	3.9	¾	½	0.74	242/242/407	22	PFZ	TFM	13	5	60	28	55
ZP29KSE	2.2	6.1	2.9	4.8	¾	½	0.74	242/242/407	23	PFZ	TFM	16	6	67	38	55
ZP31KSE	3.0	6.5	2.8	5.0	¾	½	0.74	242/242/388	23	PFZ	TFM	17	6	67	38	55
ZP36KSE	2.6	7.9	3.0	6.0	¾	½	1.25	242/242/421	30	PFZ	TFM	22	7	98	46	57
ZP42KSE	3.4	9.0	2.9	6.9	¾	½	1.25	242/242/421	31	PFZ	TFM	26	8	128	43	57
ZP54KSE	4.6	11.6	3.0	8.9	¾	½	1.24	242/242/422	34	PFZ	TFM	31	10	115	51	69
ZP61KCE	5.0	13.1	3.0	10.1	¾	½	1.66	245/249/440	40		TFD		12		64	60
ZP72KCE	6.0	15.3	3.0	11.7	¾	½	1.77	245/249/440	40		TFD		15		75	64
ZP83KCE	6.5	17.7	3.1	13.4	¾	½	1.77	241/247/440	40		TFD		15		101	61
ZP91KCE	7.5	19.3	3.1	14.7	¾	¾	1.77	243/248/443	41		TFD		16		101	61
ZP104KCE	9.0	22.7	3.2	16.8	1 ¼	¾	2.51	293/258/559	48		TFD		18.2		128	63
ZP122KCE	10.0	26.5	3.2	19.5	1 ¼	¾	2.51	293/258/559	48.8		TFD		21.6		139	63
ZP137KCE	12.0	29.9	3.2	22.1	1 ¾	¾	3.38	264/284/533	61		TFD		25		118	64
ZP154KCE	13.0	33.5	3.2	24.8	1 ¾	¾	3.38	264/284/552	65		TFD		31		140	65
ZP182KCE	15.0	39.6	3.2	29.1	1 ¾	¾	3.38	264/284/552	66		TFD		34		174	66
ZP235KCE	20.0	50.6	3.2	37.8	1 ¾	1 ¾	4.70	432/376/717	140		TWD		40		225	71
ZP295KCE	25.0	63.5	3.2	46.7	1 ¾	1 ¾	6.80	448/392/725	160		TWD		48		272	74
ZP385KCE	30.0	82.4	3.2	60.8	1 ¾	1 ¾	6.30	448/392/715	178		TWD		65		310	74
ZP485KCE	40.0	105.0	3.2	77.3	1 ¾	1 ¾	6.30	448/392/756	190		TWD		82		408	78
ZP725KCE	60.0	160.0	3.2	115	2 ½	1 ¾	6.30	482/460/863	250		FED		124		567	78

Conditions EN12900 : Evaporating 5°C, Condensing 50°C, Superheat 10K, Subcooling 0K

* 1 Ph: 230V/ 50Hz

** 3 Ph: 380-420V/ 50Hz

*** @ 1m: sound pressure level at 1m distance from the compressor, free field condition

Capacity Data

Condensing Temperature +40°C															
R410A	Cooling Capacity (kW)							R410A	Power Input (kW)						
	Evaporating Temperature (°C)								Evaporating Temperature (°C)						
Model	-15	-10	-5	0	+5	+10	+15	Model	-15	-10	-5	0	+5	+10	+15
ZP24KSE	2.2	3.0	3.9	4.9	5.9	7.1		ZP24KSE	1.5	1.5	1.4	1.4	1.4	1.3	
ZP29KSE	2.9	3.9	4.9	6.0	7.3	8.6		ZP29KSE	1.8	1.8	1.7	1.7	1.7	1.6	
ZP31KSE	3.2	4.1	5.2	6.3	7.6	9.1		ZP31KSE	1.9	1.9	1.9	1.8	1.8	1.8	
ZP36KSE	4.1	5.1	6.3	7.7	9.2	11.0		ZP36KSE	2.2	2.1	2.1	2.1	2.1	2.1	
ZP42KSE	4.4	5.7	7.1	8.7	10.5	12.5		ZP42KSE	2.4	2.4	2.4	2.4	2.3	2.3	
ZP54KSE	6.0	7.5	9.3	11.3	13.5	16.0		ZP54KSE	3.1	3.1	3.0	3.0	2.9	2.9	
ZP61KCE	6.5	8.3	10.4	12.6	15.2	18.1		ZP61KCE	3.7	3.7	3.6	3.5	3.5	3.4	
ZP72KCE	8.2	10.1	12.3	14.8	17.7	20.9		ZP72KCE	4.0	4.0	4.0	4.0	4.1	4.1	
ZP83KCE	9.4	11.6	14.2	17.1	20.4	24.2		ZP83KCE	4.5	4.5	4.5	4.6	4.6	4.7	
ZP91KCE	10.2	12.6	15.4	18.6	22.2	26.3	31.0	ZP91KCE	4.9	4.9	4.9	5.0	5.0	5.0	5.3
ZP104KCE	12.0	14.9	18.1	21.9	26.1	31.0	36.5	ZP104KCE	5.7	5.7	5.7	5.7	5.8	5.8	5.9
ZP122KCE	14.1	17.4	21.2	25.5	30.4	36.1	42.4	ZP122KCE	6.6	6.6	6.7	6.7	6.7	6.8	6.9
ZP137KCE	15.9	19.9	24.2	29.2	34.8	41.2	48.3	ZP137KCE	7.4	7.4	7.4	7.4	7.4	7.4	7.5
ZP154KCE	18.2	22.3	27.1	32.6	38.9	46.1	54.3	ZP154KCE	8.1	8.2	8.2	8.3	8.3	8.5	8.8
ZP182KCE	21.4	26.3	32.0	38.4	45.6	53.9	63.3	ZP182KCE	9.5	9.7	9.9	10.0	10.1	10.1	10.0
ZP235KCE	26.5	32.9	40.3	48.8	58.6	69.7	82.3	ZP235KCE	12.5	12.6	12.7	12.8	13.0	13.2	13.5
ZP295KCE	34.2	41.9	50.9	61.3	73.3	86.9	102.5	ZP295KCE	15.8	16.0	16.1	16.2	16.4	16.6	16.8
ZP385KCE	43.7	53.9	65.8	79.5	95.2	113.0	133.5	ZP385KCE	20.3	20.4	20.5	20.7	20.9	21.3	21.7
ZP485KCE	57.5	70.0	84.7	101.6	121.0	143.0	168.0	ZP485KCE	24.9	25.3	25.8	26.3	27.0	27.8	28.8
ZP725KCE	88.0	107.0	129.0	154.0	182.0	215.0	252.0	ZP725KCE	39.0	39.6	40.0	40.0	40.7	41.3	41.1

Conditions: Suction Superheat 10K / Subcooling 0K

Tandem and Trio Model Overview

Model	Nominal hp	Cooling Capacity (kW)	Even Tandem	Uneven Tandem	Even Trio	Uneven Trio
Tandem ZPT - Tandem Uneven ZPU - Trio ZPY - Uneven Trio ZPM						
ZPT 72 KCE*	2 x 3	16	•			
ZPT 84 KCE*	2 x 3.5	18	•			
ZPT 108 KCE*	2 x 4	23	•			
ZPT 122 KCE*	2 x 5	26	•			
ZPT 144 KCE*	2 x 6	31	•			
ZPT 166 KCE*	2 x 6.5	35	•			
ZPT 182 KCE*	2 x 8	39	•			
ZPT 180 KCE*	2 x 8	39	•			
ZPT 208 KCE*	2 x 9	45	•			
ZPT 206 KCE*	2 x 9	45	•			
ZPT 244 KCE*	2 x 10	53	•			
ZPT 240 KCE*	2 x 10	53	•			
ZPT 274 KCE*	2 x 12	60	•			
ZPY 309KCE*	3 x 9	66			•	
ZPU 302 KCE*	10 + 15	66		•		
ZPT 308KCE*	2 x 13	67	•			
ZPU 336 KCE*	13 + 15	73		•		
ZPY 360 KCE*	3 x 10	79			•	
ZPT 364 KCE*	2 x 15	79	•			
ZPY 411KCE*	3 x 12	88			•	
ZPU 417 KCE*	15 + 20	90		•		
ZPU418KCE*	20 + 15	90		•		
ZPY 462 KCE*	3 x 13	99			•	
ZPT 470 KCE*	2 x 20	101	•			
ZPT472KCE*	2 x 20	101	•			
ZPU 532KCE*	20 + 25	101	•			
ZPU 477 KCE*	15 + 25	103		•		
ZPU 530 KCE*	20 + 25	114		•		
ZPY 546 KCE*	3 x 15	117			•	
ZPT 592KCE*	2 x 25	125	•			
ZPT 590 KCE*	2 x 25	127	•			
ZPU 681KCE*	30 + 25	144		•		
ZPU 680 KCE*	25 + 30	146		•		
ZPY 705 KCE*	3 x 20	150			•	
ZPY 708KCE*	3 x 20	150			•	
ZPT 770 KCE*	2 x 30	165	•			
ZPU 870 KCE*	30 + 40	187		•		
ZPY 885 KCE*	3 x 25	188			•	
ZPT 970 KCE*	2 x 40	209	•			
ZPU 111 MCE*	30 + 60	240		•		
ZPY 115 MCE*	3 x 30	243			•	
ZPU 121 MCE*	40 + 60	262		•		
ZPM 125 MCE*	30 + 30 + 40	265				•
ZPM 135 MCE*	30 + 40 + 40	287				•
ZPY 145 MCE*	40 + 40 + 40	309			•	
ZPT 145 MCE*	60 + 60	317	•			
ZPM 169 MCE*	40 + 40 + 60	362				•
ZPM 194 MCE*	40 + 60 + 60	416				•
ZPY 218 MCE*	60 + 60 + 60	470			•	

Conditions EN 12900: Evaporating 5°C, Condensing 50°C, Superheat 10K, Subcooling 0K

* Tandem / Trio assemblies by system manufacturers. Emerson Climate Technologies can provide full technical support.

ZPD & ZRD Copeland Scroll Digital™ Compressor Range for R410A and R407C

Stepless capacity modulation in air conditioning applications:
Flexible solution for R407C and R410A.

In many cooling and heating systems, the load and the operating conditions vary over a wide range thus requiring the use of capacity modulation. Digital Scroll assures stepless modulation down to 10% of the nominal capacity, enabling precise temperature control, superior comfort and energy saving.

Digital Scroll compressors are the preferred choice for process cooling, refrigeration racks, condensing units, VRF, rooftop and air handling unit systems.



ZPD & ZRD Copeland Scroll Digital Compressor

ZPD & ZRD Digital Scroll Compressor Line-up R410A

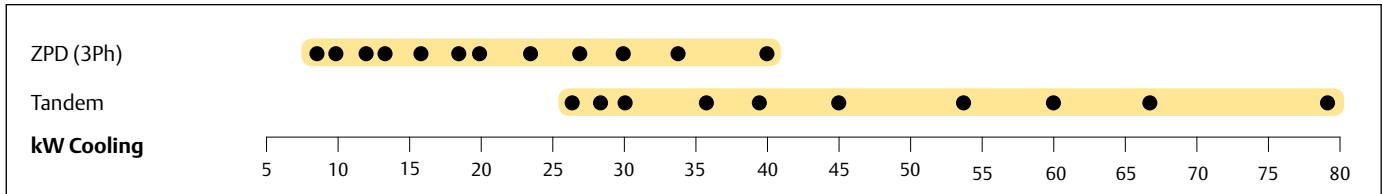

ZPD & ZRD Digital Scroll Compressor Line-up R407C

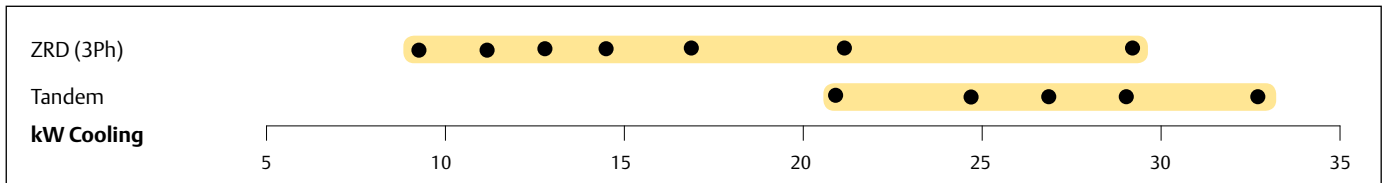

Conditions EN12900: Evaporating 5°C, Condensing 50°C, Superheat 10K, Subcooling 0K

Features and Benefits

- Wide modulation range from 10% to 100% for immediate load adjustment, close temperature comfort, optimal comfort
- No complex electronics, a quasi-drop-in solution for fast time to market, no EMI/EMC problems, easy installation and maintenance
- No impact on system mechanical balance: no vibration and resonance phenomenon, no frame / piping redesign necessary

Maximum Allowable Pressure (PS)

- Digital ZRD42 to ZRD81:
Low Side PS 20bar(g) / High Side PS 29.5 bar(g)
- Digital ZRD94 to ZRD125:
Low Side PS 20bar(g) / High Side PS 32 bar(g)
- Digital ZPD34 to ZPD91:
Low Side PS 28 bar(g) / High Side PS 43 bar(g)
- Digital ZPD103 to ZPD182:
Low Side PS 29.5 bar(g) / High Side PS 45 bar(g)

Operating Envelope R410A/R407C

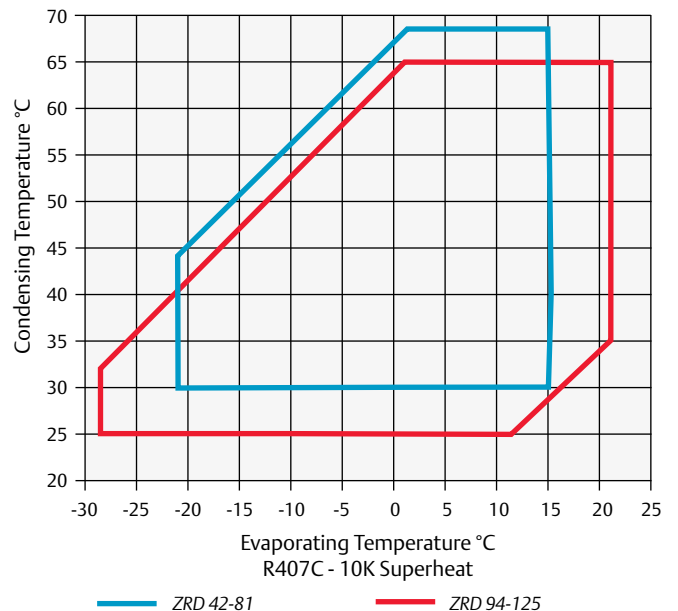
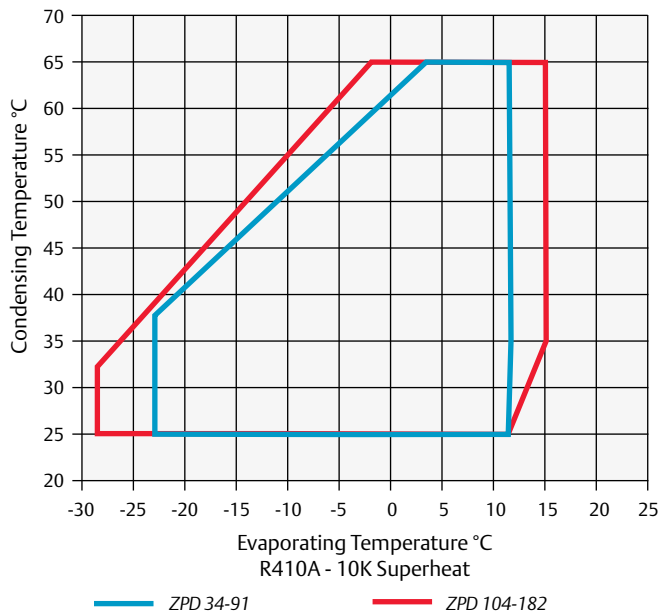

Technical Overview

Models	Nominal hp	Capacity (kW)	COP	Displacement (m ³ /h)	Stub Suction (inch)	Stub Discharge (inch)	Oil Quantity (l)	Length/Width/Height (mm)	Net Weight (kg)	Motor Version/Code	Maximum Operating Current (A)	Locked Rotor Current (A)	Sound Pressure @1 m (dBA)**
										3 Ph*	3 Ph*	3 Ph*	
ZPD34KCE	3.0	7.3	2.8	5.7	¾	½	1.24	243/243/448	31	TFM	12	64	66
ZPD42KCE	3.5	9.1	3.0	6.9	¾	½	1.24	243/243/464	31	TFM	8	52	66
ZPD54KCE	4.5	11.5	3.0	8.9	¾	½	1.24	236/236/479	35	TFM	10	62	67
ZPD61KCE	5.0	13.2	2.9	10.1	¾	½	1.89	241/246/484	41	TFD	12	64	63
ZPD72KCE	5.0	15.2	2.9	11.6	¾	½	1.89	241/246/484	40	TFD	15	75	67
ZPD83KCE	6.0	17.7	3.0	13.4	¾	½	1.77	241/246/484	40	TFD	16	101	64
ZPD91KCE	7.5	19.2	3.1	14.7	¾	¾	1.80	241/246/484	40	TFD	16	101	69
ZPD104KCE	9.0	22.4	3.2	16.7	1 ½	¾	3.25	293/285/533	61	TFD	21	111	63
ZPD122KCE	10.0	26.3	3.2	19.7	1 ½	¾	3.25	285/293/533	62	TFD	22	118	63
ZPD137KCE	12.0	29.5	3.1	22.1	1 ¾	¾	3.25	285/293/533	62	TFD	25	118	63
ZPD154KCE	13.0	33.1	3.1	24.8	1 ¾	¾	3.25	326/295/552	65	TWD	27	140	66
ZPD182KCE	15.0	39.0	3.1	29.0	1 ¾	¾	3.25	326/295/552	67	TWD	34	173	68

Conditions EN12900 R410A: Evaporating 5°C, Condensing 50°C, Superheat 10K, Subcooling 0K

* 3 Ph: 380-420V/ 50Hz

** @ 1m: sound pressure level at 1m distance from the compressor, free field condition

Preliminary data

Models	Nominal hp	Capacity (kW)	COP	Displacement (m ³ /h)	Stub Suction (inch)	Stub Discharge (inch)	Oil Quantity (l)	Length/Width/Height (mm)	Net Weight (kg)	Motor Version/Code	Maximum Operating Current (A)	Locked Rotor Current (A)	Sound Pressure @1 m (dBA)**
										3 Ph*	3 Ph*	3 Ph*	
ZRD42KCE	3.5	8.9	2.9	9.9	¾	½	1.24	241/241/462	31	TFD	7	46	60
ZRD48KCE	4.0	10.5	3.0	11.4	¾	½	1.36	241/241/465	32	TFD	10	48	64
ZRD61KCE	5.0	12.5	3.0	14.3	¾	½	1.89	241/246/481	38	TFD	9.6	64	65
ZRD72KCE	6.0	14.3	2.9	17.0	¾	¾	1.89	241/246/481	40	TFD	13	74	63
ZRD81KCE	6.0	17.0	3.1	18.7	¾	¾	1.89	241/246/481	41	TFD	15	100	67
ZRD94KCE	7.5	21.0	3.3	22.1	1 ½	¾	2.51	293/285/476	58	TFD	16	95	64
ZRD125KCE	10.0	27.7	3.3	28.8	1 ¾	¾	3.25	293/285/533	61	TFD	20	118	64

Conditions EN12900 R407C: Evaporating 5°C, Condensing 50°C, Superheat 10K, Subcooling 0K

* 3 Ph: 380-420V/ 50Hz

** @ 1m: sound pressure level at 1m distance from the compressor, free field condition

Capacity Data

Condensing Temperature +40°C															
R410A	Cooling Capacity (kW)							R410A	Power Input (kW)						
	Evaporating Temperature (°C)								Evaporating Temperature (°C)						
Model	-15	-10	-5	0	+5	+10	+15	Model	-15	-10	-5	0	+5	+10	+15
ZPD34KSE	3.9	5.0	6.2	7.6	9.2	11.0		ZPD34KSE	2.1	2.1	2.1	2.0	2.0	2.0	
ZPD42KSE	4.8	5.9	7.3	8.8	10.6	12.6		ZPD42KSE	2.3	2.3	2.4	2.4	2.4	2.3	
ZPD54KSE	6.5	7.9	9.5	11.4	13.5	16.0		ZPD54KSE	3.1	3.1	3.1	3.0	3.0	3.0	
ZPD61KCE	6.9	8.6	10.5	12.7	15.3	18.2		ZPD61KCE	3.3	3.4	3.5	3.5	3.6	3.6	
ZPD72KCE	8.2	10.1	12.3	14.8	17.6	20.9		ZPD72KCE	3.9	4.0	4.1	4.1	4.2	4.2	
ZPD83KCE	9.7	11.9	14.4	17.2	20.5	24.1		ZPD83KCE	4.5	4.6	4.7	4.7	4.8	4.9	
ZPD91KCE	10.1	12.6	15.3	18.5	22.1	26.2	30.9	ZPD91KCE	4.9	5.0	5.0	5.0	5.1	5.0	5.0
ZPD104KCE	11.7	14.6	17.9	21.6	25.8	30.5	35.7	ZPD104KCE	5.7	5.7	5.6	5.6	5.7	5.8	5.9
ZPD122KCE	13.8	17.3	21.2	25.6	30.6	36.1	42.2	ZPD122KCE	6.7	6.7	6.6	6.6	6.6	6.7	6.8
ZPD137KCE	15.5	19.4	23.7	28.7	34.2	40.3	47.2	ZPD137KCE	7.5	7.5	7.5	7.4	7.4	7.5	7.6
ZPD154KCE	17.8	22.0	26.6	31.9	38.0	45.0	53.0	ZPD154KCE	8.2	8.3	8.4	8.5	8.6	8.7	8.9
ZPD182KCE	22.3	26.8	32.0	37.9	44.6	52.5	61.6	ZPD182KCE	9.8	9.9	10.0	10.1	10.2	10.4	10.5

Conditions: Suction Superheat 10K / Subcooling 0K

Preliminary data

Condensing Temperature +40°C															
R407C	Cooling Capacity (kW)							R407C	Power Input (kW)						
	Evaporating Temperature (°C)								Evaporating Temperature (°C)						
Model	-15	-10	-5	0	+5	+10	+15	Model	-15	-10	-5	0	+5	+10	+15
ZRD42KCE	4.3	5.4	6.7	8.3	10.1	12.2	14.6	ZRD42KCE	2.0	2.1	2.1	2.2	2.2	2.3	2.3
ZRD48KCE	4.9	6.4	8.0	10.0	12.3	15.0	18.1	ZRD48KCE	2.5	2.6	2.6	2.7	2.7	2.8	2.9
ZRD61KCE	6.1	7.7	9.5	11.7	14.2	17.3	21.0	ZRD61KCE	3.0	3.1	3.2	3.4	3.4	3.4	3.3
ZRD72KCE	3.5	6.0	8.9	12.3	16.2	20.6	25.6	ZRD72KCE	3.5	3.6	3.7	3.8	4.0	4.1	4.3
ZRD81KCE	8.0	10.2	12.8	15.8	19.2	23.2	27.7	ZRD81KCE	4.3	4.4	4.4	4.5	4.6	4.7	4.8
ZRD94KCE	10.0	12.7	16.0	19.8	24.1	28.9	34.5	ZRD94KCE	5.0	5.1	5.1	5.1	5.1	5.2	5.3
ZRD125KCE	13.2	16.9	21.3	26.3	31.7	37.6	43.7	ZRD125KCE	6.5	6.6	6.6	6.7	6.8	6.9	7.1

Conditions: Suction Superheat 10K / Subcooling 0K



ZPV Copeland Scroll™ Variable Speed Compressor Range for R410A with inverter drive

Copeland Scroll™ ZPV Variable Speed compressors are designed to deliver maximum cooling and heating efficiency when you need it most. Equipped with the latest variable speed technology, they allow system manufacturers and building owners to achieve superior performance when designing reversible chillers, heat pumps, precision cooling systems or rooftops.

In addition to Copeland market-proven robustness, the new ZPV range with its qualified inverter drive meets and exceeds the level of reliability expected for these applications.



Copeland Scroll™ ZPV063
Variable Speed compressor and drive

ZPV Variable Speed Scroll Compressor Line-up

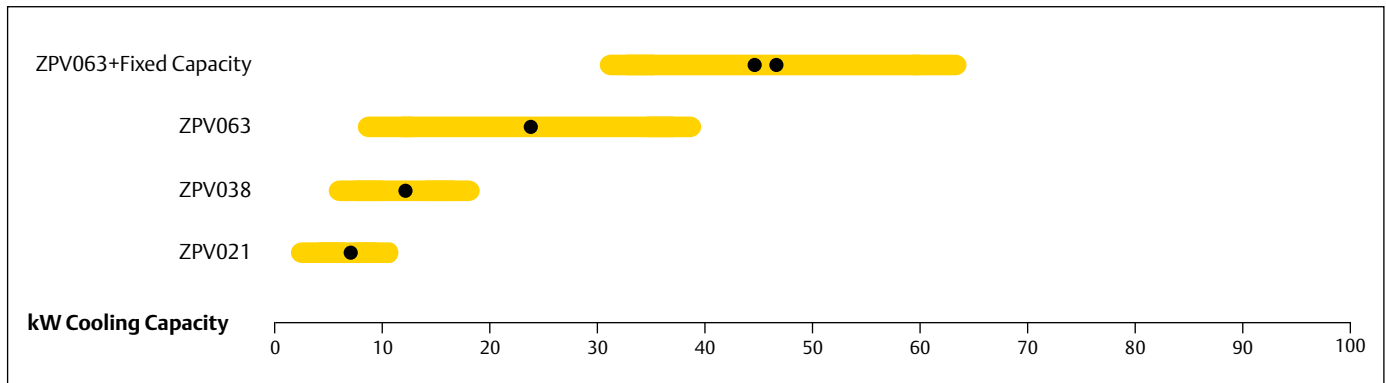

Conditions EN12900: Evaporating 5°C, Condensing 50°C, Superheat 10K, Subcooling 0K

Features and Benefits

- Highest part load efficiency in its class enabling significant energy savings and standards compliance
- Wide speed range for enhanced part load efficiency and dehumidification: 1,000-7,200 RPM (17-120Hz)
- Capability to be tandemized with fix speed compressors for maximum flexibility in system design
- Both compressor and drive are Copeland™ approved for reduced design time, cost and speed to market
- BPM motor technology for highest efficiency
- Sound reduction technology for reversible chiller transition and defrost

Maximum Allowable Pressure (PS)

- ZPV021-038
Low Side PS 28 bar(g) / High Side PS 43.3 bar(g)
- ZPV063
Low Side PS 28 bar(g) / High Side PS 45 bar(g)

Operating Envelope R410A

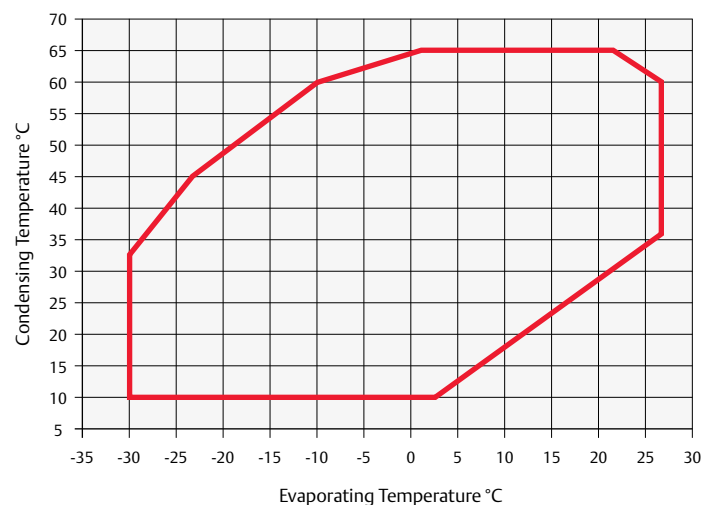

Technical Overview

Compressor										
R410A	Capacity (kW)		COP*	Displacement (cm ³ /rev)	Stub Suction (inch)	Stub Discharge (inch)	Oil Quantity (l)	Length/Width/Height (mm)	Net Weight (kg)	Sound Pressure @1 m (dBA)**
	Min	Max								
ZPV0212P	2.7	10.5	2.8	21.0	⅜	½	1.70	229/198/394	21	68
ZPV0382P	4.9	19.0	2.9	38.0	⅜	½	1.70	229/198/394	22	68
ZPV0631E	8.8	37.6	3.1	63.0	1 ⅜	⅞	2.51	293/258/559	49	79

Conditions EN12900: Evaporating 5°C, Condensing 50°C, Superheat 10K, Subcooling 0K

*@ Nominal Speed (50Hz)

** @ 1m: sound pressure level at 1m distance from the compressor, free field condition

preliminary data

Inverter Drive										
Model	Matched Compressor	Capacity (kW)		Frequency (Hz)		Net Weight (kg)	1Ph 230V	3Ph 400V	Comm	Length/Width/Height (mm)*
		Nominal	Cooling	Min	Max					
EV2033M	ZPV021	3.3	Air / Liquid	15	120	3.6	√	n.a.	Modbus	228/260/156
EV2037M	ZPV021-038	3.7		15	120	3.6	√	n.a.		228/260/119
EV2055M	ZPV021-038	5.5		15	120	3.6	√	√		228/260/119
EV2080M	ZPV038	8.0		15	120	5.1	√	√		228/260/156
EVC1150	ZPV063	15.0	Air	17	120			√		143/202/379

Conditions: Suction Superheat 5K, Subcooling 4K

*Air cooled version including fins

Capacity Data

Condensing Temperature +50°C																	
R410A		Cooling Capacity (kW)							R410A		Drive Power Input (kW)						
		Evaporating Temperature (°C)									Evaporating Temperature (°C)						
Models		-15	-10	-5	0	+5	+10	+15	Models		-15	-10	-5	0	+5	+10	+17
ZPV0212P	Max	5.1	6.5	8.0	9.7	11.0	13.1	15.5	ZPV0212P	Max	1.4	3.7	3.8	3.8	3.6	3.6	3.5
	Min	1.6	1.6	1.9	2.4	2.8	3.4	4.0		Min	1.2	1.0	1.0	1.0	1.0	1.0	0.9
ZPV0382P	Max	10.2	12.4	15.1	17.8	20.0	23.5	27.5	ZPV0382P	Max	1.7	6.2	6.5	6.6	6.3	6.3	6.2
	Min	2.8	2.7	3.3	4.2	5.1	6.2	7.3		Min	1.9	1.6	1.6	1.6	1.7	1.7	1.7
ZPV0631E	Max	17.4	21.6	26.5	32.1	28.5	45.9	54.3	ZPV0631E	Max	13.2	13.2	13.3	13.4	13.4	13.6	13.7
	Min	5.8	4.7	5.7	6.8	8.0	9.4	11.1		Min	4.2	3.1	3.0	3.0	3.0	2.9	2.9

Conditions: Suction Superheat 5K, Subcooling 4K

ZH Copeland Scroll™ Fixed Speed Compressor Range for R410A and R407C

ZH Copeland Scroll Compressor Range

The ZH compressor range is optimized for reversible and heat pump applications. In addition to the existing R407C range, a complete new range optimized for R410A has been developed. Both ranges are based on three platform sizes and cover a capacity of 4kW to 38kW.

ZH heating compressors have been optimized for reversible heating systems, they deliver higher capacity and efficiency at low evaporating (heat source) temperatures and are therefore better adapted to heating requirements than standard air conditioning compressors. Due to their larger operating map they also require less additional heating (electrical or gas) to cover the full heating demand on the coldest days and therefore further improve the system seasonal efficiency.

ZH Scroll Compressors with Enhanced Vapor Injection

ZH heating compressors with Enhanced Vapor Injection have been further optimized to ensure best-in-class performances in dedicated heating applications. This technology allows replacement of traditional boilers in new building and retrofit applications, without the need of substituting existing heating elements in the building.

ZH Copeland Scroll heating compressors with Enhanced Vapor Injection have an additional port to inject vapor within the compression process. This improves system performances by increasing the heating capacity for a given compressor displacement. Additional benefits are the reduction of the gas discharge temperature and the extension of the operating envelope which enable the production of high temperature water at all working conditions.

ZHI heating compressors reach the same high standards of durability and reliability as other Copeland Scroll compressors. This includes the ability to handle relatively large amounts of liquid, which is known to damage or cause compressor failures. Fewer moving parts, robust running gear and low vibration due to balanced compression mechanism make the ZH range of Copeland Scroll compressors the most reliable solution available in the heat pump market.



ZH Scroll Compressor

ZH Nomenclature Guidelines

ZH**K4E

Qualified for **R407C/R134a**

Without Enhanced Vapor Injection - ** capacity in Btu/h

ZH**KVE

Qualified for **R407C** only

Enhanced Vapor Injection - ** capacity in kW

ZH**K1P

Qualified for **R410A** only

Without Enhanced Vapor Injection - ** capacity in kW

ZHI**K1P

Qualified for **R410A** only

Enhanced Vapor Injection - ** capacity in kW

Enhanced Vapor Injection: System Design

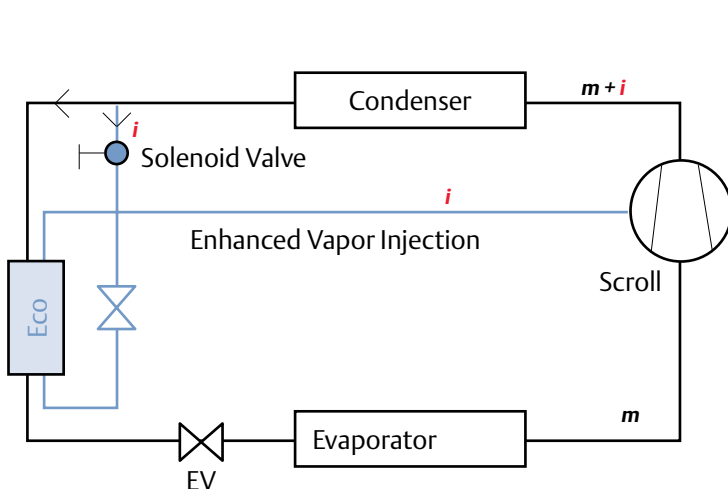

Enhanced Vapor Injection: Enthalpy Diagram

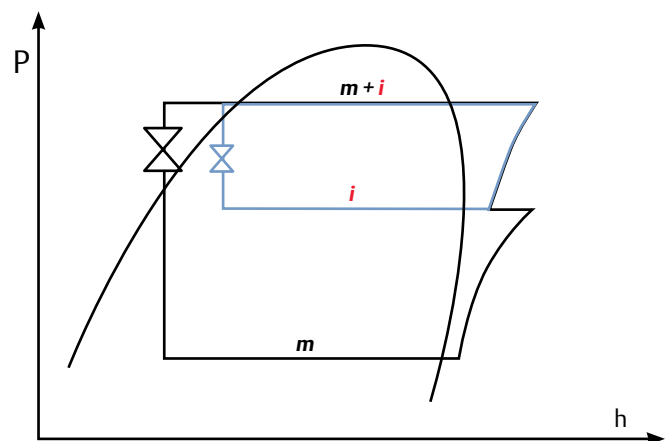

ZH / ZH*KVE Scroll Compressor Line-up R407C

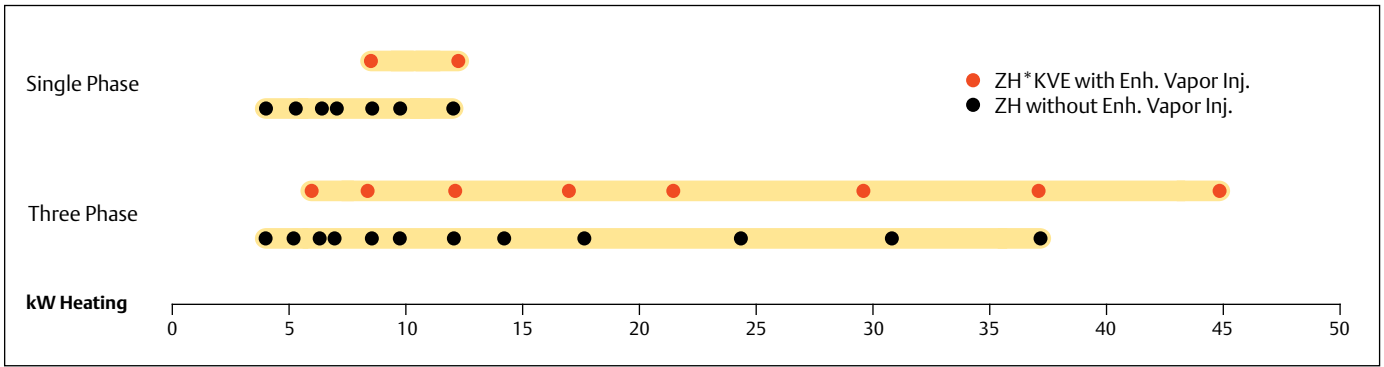

Conditions: Evaporating -7°C, Condensing 50°C, 4K Subcooling, 5K Superheat

ZH*P / ZHI*P Scroll Compressor Line-up R410A

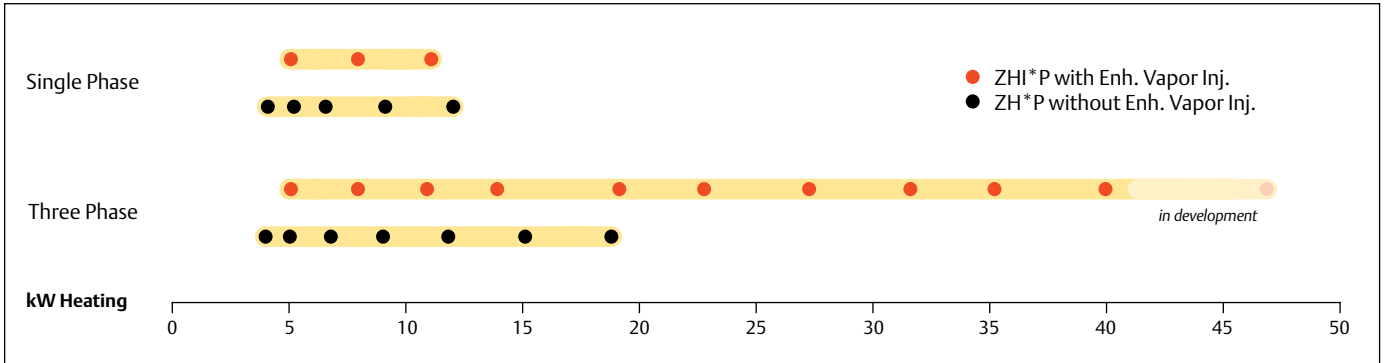

Conditions: Evaporating -7°C, Condensing 50°C, 4K Subcooling, 5K Superheat

Features and Benefits

- Copeland Scroll axial and radial compliance for high reliability
- High efficiency and increased heating capacity
- High water temperature for all applications
- Low sound and low vibration level
- Tandem combination for superior seasonal efficiency
- Enhanced Vapor Injection technology for best seasonal efficiency

Maximum Allowable Pressure (PS)

- ZH(I)04K1P to ZH(I)23K1P:
Low Side PS 28 bar(g) / High Side PS 45 bar(g)
- ZHI27K1P to ZHI40K1P:
Low Side PS 29.5 bar(g) / High Side PS 53 bar(g)
- ZH12K4E to ZH45K4E:
Low Side PS 20 bar(g) / High Side PS 32 bar(g)
- ZH56K4E to ZH11M4E:
Low Side PS 22.6 bar(g) / High Side PS 32 bar(g)
- ZH09KVE to ZH18KVE:
Low Side PS 20 bar(g) / High Side PS 32 bar(g)
- ZH24KVE to ZH48KVE:
Low Side PS 22.6 bar(g) / High Side PS 32 bar(g)

Operating Envelope R410A Heating

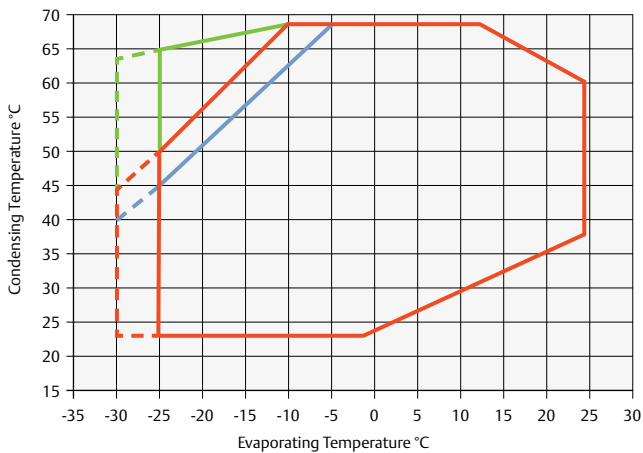

- ZH*P without Enh. Vapor Inj.
- - - ZH*P 2000 hours max.
- ZHI*P with Enh. Vapor Inj.
- - - ZHI*P 2000 hours max.
- Wet Injection

Operating Envelope R407C Heating

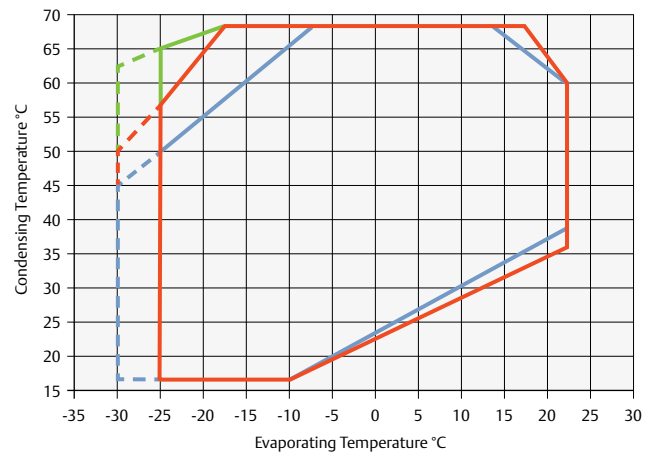

- ZH without Enh. Vapor Inj.
- - - ZH 2000 hours max.
- ZH*KVE with Enh. Vapor Inj.
- - - ZH*KVE 2000 hours max.
- Wet Injection

Refer to Emerson's Select selection software for individual model operating envelopes and other refrigerants.

Technical Overview

Models	Nominal hp	Capacity (kW)	COP	Displacement (m ³ /h)	Stub Suction (inch)	Stub Discharge (inch)	Oil Quantity (l)	Length/Width/Height (mm)	Net Weight (kg)	Motor Version/Code		Maximum Operating Current (A)		Locked Rotor Current (A)		Sound Pressure @1 m (dBA) ***
										1 Ph*	3 Ph**	1 Ph*	3 Ph**	1 Ph*	3 Ph**	
ZH04 K1P	1.8	4.2	2.8	3.4	¾	½	0.7	229/198/388	22	PFZ	TFM	9	5	50	28	62
ZH05 K1P	2.0	5.0	2.8	4.0	¾	½	0.7	242/242/407	22	PFZ	TFM	13	5	60	28	62
ZH06 K1P	2.7	6.6	2.9	5.1	¾	½	1.2	242/242/422	31	PFZ	TFM	17	6	83	44	62
ZH09 K1P	3.5	9.0	3.1	6.9	¾	½	1.2	242/242/422	33	PFZ	TFM	23	7	108	52	62
ZH12 K1P	4.5	11.4	3.0	8.9	¾	½	1.2	242/242/422	35	PFZ	TFM	28	10	130	62	65
ZH15 K1P	5.0	15.1	3.1	11.7	¾	½	1.9	245/249/443	39		TFM		13		75	67
ZH19 K1P	6.5	18.7	3.2	14.8	¾	¾	1.9	229/198/443	39		TFM		17			67
ZHI05 K1P	1.9	5.2	3.0	3.4	¾	½	0.7	229/198/388	22	PFZ	TFM	14	4	60	28	63
ZHI08 K1P	2.8	8.2	3.1	5.1	¾	½	1.2	229/246/418	31	PFZ	TFM	19	6	108	43	63
ZHI11 K1P	3.6	10.8	3.2	6.9	¾	½	1.2	2428/242/421	31	PFZ	TFM	25	9	130	52	65
ZHI14 K1P	4.6	13.9	3.3	8.9	¾	½	1.2	2428/242/421	34		TFM		11		70	65
ZHI18 K1P	5.0	17.9	3.4	11.7	¾	½	1.9	249/245/455	41		TFM		15			67
ZHI23 K1P	6.5	22.8	3.4	14.8	¾	¾	1.9	249/245/455	41		TFM		19			67
ZHI27 K1P	9	27.0	3.3	16.8	1 ¾	¾	3.3	264/285/533	63		TFD				118	77
ZHI32 K1P	10	31.7	3.2	19.8	1 ¾	¾	3.3	264/285/533	63		TFD				140	75
ZHI35 K1P	12	35.6	3.2	22.1	1 ¾	¾	3.3	264/285/552	63		TFD				174	76
ZHI40 K1P	13	39.7	3.3	24.9	1 ¾	¾	3.3	264/285/552	64		TFD				174	76

Conditions: Evaporating -7°C, Condensing 50°C, Superheat 5K, Subcooling 4K

* 1 Ph: 230V/ 50Hz

** 3 Ph: 380-420V/ 50Hz

*** @ 1m: sound pressure level at 1m distance from the compressor, free field condition

R407C	Nominal hp	Capacity (kW)	COP	Displacement (m ³ /h)	Stub Suction (inch)	Stub Discharge (inch)	Oil Quantity (l)	Length/Width/Height (mm)	Net Weight (kg)	Motor Version/Code		Maximum Operating Current (A)		Locked Rotor Current (A)		Sound Pressure @1 m (dBA) ***
										1 Ph*	3 Ph**	1 Ph*	3 Ph**	1 Ph*	3 Ph**	
ZH12K4E	1.7	3.7	3.0	4.7	¾	½	0.7	272/193/388	21	PFZ		10		44		53
ZH15K4E	2.0	4.6	3	5.8	¾	½	1.3	243/242/364	23	PFJ	TFD	11.6	4.3	61	26	60
ZH21K4E	3.0	6.5	3.1	8.0	¾	½	1.5	243/242/387	27	PFJ	TFD	16	5	76	32	59
ZH26K4E	3.5	8.2	3.1	10.0	¾	½	3.1	243/242/400	28	PFJ	TFD	20	7	97	46	63
ZH30K4E	4.0	9.5	3.1	11.7	¾	½	1.9	247/241/438	38	PFJ	TFD	25	8	108	52	62
ZH38K4E	5.0	11.7	3.2	14.4	¾	½	1.9	247/241/438	38	PFZ	TFD	31	10	150	64	63
ZH45K4E	6.0	14.0	3.2	17.1	¾	½	1.9	250/246/450	36		TFD		12		74	64
ZH56K4E	7.5	17.4	3.1	20.9	1 ¾	¾	4.0	357/321/525	93		TWD		17		99	69
ZH75K4E	10.0	24.2	3.2	28.8	1 ¾	¾	4.0	357/321/525	93		TWD		21		127	70
ZH92K4E	13.0	30.7	3.3	35.6	1 ¾	¾	4.1	357/321/532	95		TWD		25		167	72
ZH11M4E	15.0	37.0	3.3	42.8	1 ¾	¾	4.1	357/321/579	112		TWD		32		198	72
ZH06KVE	2.5	6.2	3.3	5.8	¾	½	1.3	242/242/386	27.5		TFM		4.4		26	62
ZH09KVE	3.0	8.2	3.3	8.0	¾	½	1.5	243/243/386	30	PFZ	TFD	21	7	97	40	62
ZH13KVE	4.0	11.8	3.4	11.7	¾	½	1.9	244/241/438	38	PFZ	TFD	30	10	160	64	65
ZH18KVE	6.0	16.7	3.4	17.1	¾	½	1.9	244/241/438	41		TFD		14		101	67
ZH24KVE	7.5	21.3	3.3	20.9	1 ¾	¾	4.0	368/321/525	93		TWD		18		99	73
ZH33KVE	10.0	29.5	3.4	29.0	1 ¾	¾	4.0	368/321/525	93		TWD		24		127	73
ZH40KVE	13.0	37.0	3.4	35.5	1 ¾	¾	4.1	368/321/532	103		TWD		30		167	73
ZH48KVE	15.0	44.7	3.4	42.8	1 ¾	¾	4.1	368/323/579	112		TWD		36		198	76

Conditions: Evaporating -7°C, Condensing 50°C, Superheat 5K, Subcooling 4K

* 1 Ph: 230V/ 50Hz

** 3 Ph: 380-420V/ 50Hz

*** @ 1m: sound pressure level at 1m distance from the compressor, free field condition

Capacity Data

Condensing Temperature +50°C															
R410A	Heating Capacity (kW)							R410A	Power Input (kW)						
	Evaporating Temperature (°C)								Evaporating Temperature (°C)						
Model	-30	-15	-10	-5	0	+5	+15	Model	-30	-15	-10	-5	0	+5	+15
ZH04 K1P	n.a.	3.3	3.9	4.5	5.2	6.0	7.6	ZH04 K1P	n.a.	1.4	1.5	1.5	1.5	1.5	1.5
ZH09 K1P	n.a.	7.1	8.2	9.5	10.9	12.5	16.4	ZH09 K1P	n.a.	2.8	2.9	3.0	3.0	3.0	3.0
ZH12 K1P	n.a.	9.2	10.5	12.1	13.9	15.9	21.0	ZH12 K1P	n.a.	3.7	3.7	3.8	3.8	3.8	3.8
ZH15 K1P	n.a.	12.0	13.8	15.9	18.4	21.1	27.7	ZH15 K1P	n.a.	4.7	4.9	5.0	5.1	5.2	5.2
ZH19 K1P	n.a.	15.2	17.5	20.2	23.2	26.7	35.1	ZH19 K1P	n.a.	6.0	6.2	6.3	6.4	6.5	6.5
Models with Enhanced Vapor Injection															
Model	-30	-15	-10	-5	0	+5	+15	Model	-30	-15	-10	-5	0	+5	+15
ZHI05 K1P	2.6	4.2	4.8	5.4	6.1	6.9	8.6	ZHI05 K1P	1.7	1.7	1.7	1.8	1.8	1.8	1.7
ZHI08 K1P	5.0	6.7	7.6	8.4	9.4	10.5	13.1	ZHI08 K1P	2.5	2.6	2.6	2.6	2.6	2.6	2.4
ZHI11 K1P	6.4	9.0	10.1	11.3	12.6	14.0	17.2	ZHI11 K1P	3.2	3.3	3.3	3.3	3.3	3.3	3.1
ZHI14 K1P	8.5	11.6	13.0	14.5	16.2	18.1	22.3	ZHI14 K1P	3.9	4.1	4.2	4.2	4.2	4.2	4.0
ZHI18 K1P	10.8	14.9	16.7	18.7	20.9	23.2	28.7	ZHI18 K1P	5.1	5.3	5.4	5.4	5.4	5.3	5.2
ZHI23 K1P	13.8	19.0	21.3	23.9	26.6	29.7	36.7	ZHI23 K1P	6.6	6.8	6.9	6.9	6.9	6.8	6.6
ZHI27 K1P	14.2	22.1	25.1	28.4	31.8	35.5	43.8	ZHI27 K1P	7.9	8.2	8.2	8.1	8.1	7.9	7.5
ZHI32 K1P	16.4	26.1	29.5	33.2	37.1	41.4	51.1	ZHI32 K1P	8.7	9.7	9.8	9.8	9.7	9.6	9.4
ZHI35 K1P	19.5	29.2	33.1	37.3	41.9	46.7	57.4	ZHI35 K1P	11.0	10.8	10.9	11.0	11.1	11.2	11.1
ZHI40 K1P	21.7	32.5	36.9	41.7	47.0	52.7	65.6	ZHI40 K1P	12.0	12.0	12.1	12.1	12.2	12.2	12.3

Conditions: Suction Superheat 5K / Subcooling 4K

Condensing Temperature +50°C															
R407C	Heating Capacity (kW)							R407C	Power Input (kW)						
	Evaporating temperature (°C)								Evaporating temperature (°C)						
Model	-30	-15	-10	-5	0	+5	+15	Model	-30	-15	-10	-5	0	+5	+15
ZH12K4E	n.a.	2.8	3.3	3.9	4.6	5.4	7.5	ZH12K4E	n.a.	1.2	1.2	1.3	1.3	1.3	1.4
ZH15K4E	n.a.	3.6	4.3	5.0	5.8	6.8	9.2	ZH15K4E	n.a.	1.5	1.5	1.6	1.6	1.6	1.9
ZH21K4E	n.a.	5.1	5.9	6.9	8.1	9.6	13.2	ZH21K4E	n.a.	2.0	2.1	2.1	2.2	2.3	2.4
ZH26K4E	n.a.	6.3	7.4	8.7	10.3	12.1	16.5	ZH26K4E	n.a.	2.5	2.6	2.7	2.7	2.8	3.0
ZH30K4E	n.a.	7.3	8.6	10.1	11.9	14.0	19.2	ZH30K4E	n.a.	2.9	3.0	3.1	3.2	3.3	3.4
ZH38K4E	n.a.	9.0	10.6	12.5	14.6	17.2	23.4	ZH38K4E	n.a.	3.5	3.6	3.8	3.9	4.0	4.2
ZH45K4E	n.a.	10.8	12.7	14.9	17.4	20.3	27.2	ZH45K4E	n.a.	4.2	4.3	4.5	4.6	4.7	5.1
ZH56K4E	n.a.	13.4	15.8	18.6	21.8	25.5	34.1	ZH56K4E	n.a.	5.3	5.5	5.7	6.0	6.2	6.8
ZH75K4E	n.a.	18.5	21.9	25.8	30.3	35.5	47.6	ZH75K4E	n.a.	7.0	7.4	7.7	8.0	8.2	8.5
ZH92K4E	n.a.	23.4	27.8	32.8	38.5	45.1	60.3	ZH92K4E	n.a.	8.5	9.0	9.5	10.0	10.4	11.2
ZH11M4E	n.a.	28.4	33.6	39.5	46.3	54.3	72.7	ZH11M4E	n.a.	10.3	10.9	11.5	11.9	12.5	13.4
Models with Enhanced Vapor Injection															
	-30	-15	-10	-5	0	+5	+15		-30	-15	-10	-5	0	+5	+15
ZH06KVE	3.3	4.9	5.7	6.5	7.4	8.4	10.8	ZH06KVE	1.7	1.8	1.9	1.9	2.0	2.0	2.1
ZH09KVE	4.1	6.6	7.6	8.7	9.9	11.2	14.3	ZH09KVE	2.1	2.4	2.4	2.5	2.6	2.6	2.6
ZH13KVE	5.7	9.5	10.9	12.5	14.3	16.2	20.7	ZH13KVE	3.0	3.4	3.5	3.5	3.6	3.6	3.7
ZH18KVE	8.0	13.5	15.4	17.6	20.0	22.6	28.7	ZH18KVE	4.2	4.8	4.9	5.0	5.1	5.1	5.2
ZH24KVE	9.7	17.0	19.6	22.5	25.5	28.9	36.7	ZH24KVE	5.2	6.2	6.4	6.6	6.7	6.8	7.0
ZH33KVE	14.3	23.7	27.2	31.1	35.3	40.0	50.7	ZH33KVE	7.0	8.2	8.5	8.8	9.1	9.3	9.6
ZH40KVE	18.1	29.6	34.1	39.1	44.7	50.9	65.5	ZH40KVE	8.9	10.2	10.6	11.0	11.3	11.7	12.4
ZH48KVE	21.1	35.6	41.1	47.2	54.1	61.8	80.4	ZH48KVE	10.0	12.2	12.7	13.2	13.5	14.0	15.1

Conditions: Suction Superheat 5K / Subcooling 4K

ZHV & ZHW Copeland Scroll™ Variable Speed Compressor Range for R410A with inverter drive

ZHV and ZHW Variable Speed scroll compressors for R410A, for outstanding performance for cooling and heating applications.

The new Emerson Climate Technologies solution for variable speed applications with capacity modulated compressors. ZHV and ZHW compressors deliver outstanding performances, both in new building and retrofit applications. Variable Speed Copeland Scroll compressors feature a state-of-the-art brushless permanent magnet motor matched with a highly efficient drive and vapor injection technology (ZHW only). In addition to Copeland market-proven robustness, ZHV and ZHW compressors with the qualified inverter drive meet and exceed the level of reliability expected for these demanding applications.



ZHW Copeland Scroll Variable Speed Compressor and Inverter Drive

ZHV & ZHW Variable Speed Scroll Compressor Line-up

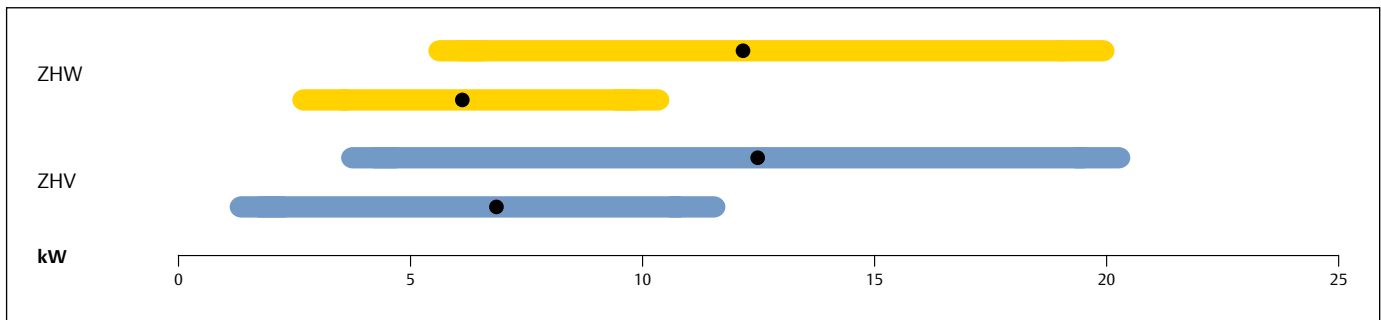

Conditions: Cooling kW Evaporating 5°C, Condensing 50°C, Superheat 10K, Subcooling 0K
Heating kW Evaporating -7°C, Condensing 50°C, 4K Subcooling, 5K Superheat

Features and Benefits

- Highest efficiency throughout the operating envelope and speed range
- Envelope and speed management information for the system controller (real-time communication via Modbus RS485)
- Enhanced Vapor Injection technology for best seasonal efficiency (ZHW)
- High water temperature for all applications (ZHW)
- Compliance with electromagnetic-compatibility (EMC) and electromagnetic-interference (EMI) requirements for residential applications (VDE)
- Wide speed range 15-117Hz
- Mutually optimized and qualified scroll and drive

Operating Envelope R410A

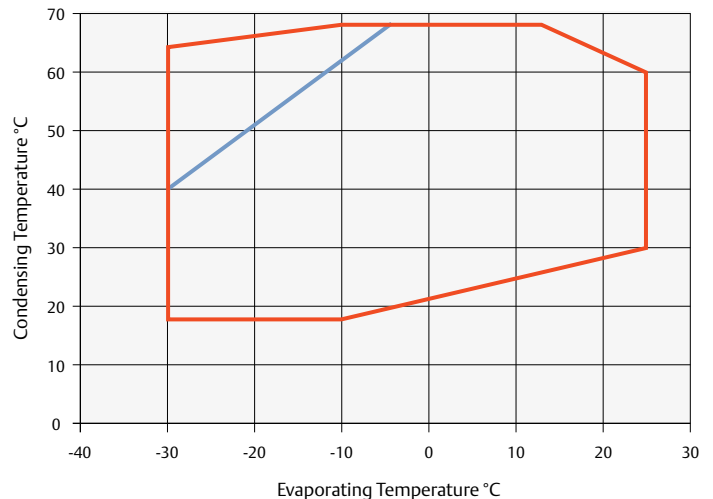

Maximum Allowable Pressure (PS)

- ZHW:
Low Side PS 28 bar(g) / High Side PS 45 bar(g)
- ZHV:
Low Side PS 28 bar(g) / High Side PS 43 bar(g)

Technical Overview

Compressor										
Models	Capacity (kW)		COP*	Displacement (m ³ /h)	Stub Suction (inch)	Stub Discharge (inch)	Oil Quantity (l)	Length/Width/Height (mm)	Net Weight (kg)	Sound Pressure @1 m (dBA)**
	Min	Max								
ZHW0152P	2.7	10.4	3.1	15.0	¾	½	1.7	229/198/394	21	68
ZHW0302P	5.5	19.8	3.2	30.0	¾	½	1.7	229/198/394	22	68
ZHV0212P	2.7	11.0	2.9	21.0	¾	½	1.7	229/198/394	21	68
ZHV0342P	3.9	17.4	3.0	34.0	¾	½	1.7	229/198/394	22	68

Conditions: Heating kW, Evaporating -7°C, Condensing 50°C, 4K Subcooling, 5K Superheat

*@ Nominal Speed (50Hz)

** @ 1m: sound pressure level at 1m distance from the compressor, free field condition

Inverter Drive										
Model	Matched Compressor	Capacity (kW)		Frequency (Hz)		Net Weight (kg)	1Ph 230V	3Ph 400V	Comm	Length/Width/Height (mm)*
		Nominal	Cooling	Min	Max					
EV2033M	ZHV021 ZHW015	3.3	Air/Liquid	15	120	3.6	√	n.a.	Modbus	228/260/156
EV2037M	ZHV021-34 ZHW015	3.7		15	120	6.8	√	n.a.		228/260/119
EV2055M	ZHV021-34 ZHW015-30	5.5		15	120	6.8	√	√		228/260/119
EV2080M	ZHV034 ZHW030	8.0		15	120	5.1	√	√		228/260/156

* Air-cooled version including fins

Capacity Data

Condensing Temperature +50°C																	
R410A		Heating Capacity (kW)							R410A		Drive Power Input (kW)						
		Evaporating Temperature (°C)									Evaporating Temperature (°C)						
Model		-30	-15	-10	-5	0	+5	+15	Model		-30	-15	-10	-5	0	+5	+15
ZHW0152P	Max	6.0	8.6	9.7	11.0	12.0	12.0	12.4	ZHW0152P	Max	3.1	3.3	3.3	3.4	3.2	2.9	2.4
	Min	2.0	2.6	2.8	2.9	3.1	3.1	3.8		Min	1.3	1.1	1.1	1.0	0.9	0.9	0.9
ZHW0302P	Max	11.3	16.3	18.5	20.8	22.6	22.6	23.7	ZHW0302P	Max	5.7	6.0	6.1	6.1	5.7	5.4	4.4
	Min	4.2	5.2	5.8	5.9	6.6	6.6	8.1		Min	2.4	2.0	2.0	1.9	1.7	1.7	1.7

Conditions: Suction Superheat 10K, Subcooling 4K

Condensing Temperature +50°C																	
R410A		Cooling Capacity (kW)							R410A		Drive Power Input (kW)						
		Evaporating Temperature (°C)									Evaporating Temperature (°C)						
Model		-20	-15	-10	-5	0	+5	+15	Model		-20	-15	-10	-5	0	+5	+15
ZHV0212P	Max	7.0	8.4	9.9	11.5	13.1	14.0	14.0	ZHV0212P	Max	3.3	3.5	3.6	3.8	3.8	2.9	2.6
	Min	2.3	2.7	3.0	3.3	3.3	3.7	4.9		Min	1.1	1.1	1.1	1.1	1.0	1.0	0.9
ZHV0342P	Max	11.7	13.5	15.7	18.3	20.6	21.8	21.5	ZHV0342P	Max	4.8	5.1	5.2	5.7	5.7	5.2	3.9
	Min	3.5	4.0	4.3	5.0	4.9	5.7	7.6		Min	1.6	1.6	1.6	1.6	1.4	1.4	1.5

Conditions: Suction Superheat 5K, Subcooling 4K

ZH Copeland Scroll™ For Heat Recovery and High Condensing Applications for R134a

ZH*KCE R134a Copeland Scroll compressors were developed for the recovery and reuse of available heat. For example, the heat generated by processes or machining cooling equipment can be recovered and not wasted. This contributes to reducing the total energy cost of installations. On a water-cooled chiller, heat recovery on the condensing water loop can be used to produce high temperature water for sanitary or premise heating. With a typical evaporating temperature between 20°C and 40°C and condensing up to 85°C, ZH*KCE scrolls offer many opportunities of heat recovery.

The range of products goes from the ZH40KCE (7.5Hp) to the ZH150 (30Hp) which can be tandemized.



ZH*KCE Scroll Compressor For Heat Recovery

ZH*KCE Scroll Compressor Line-up R134a

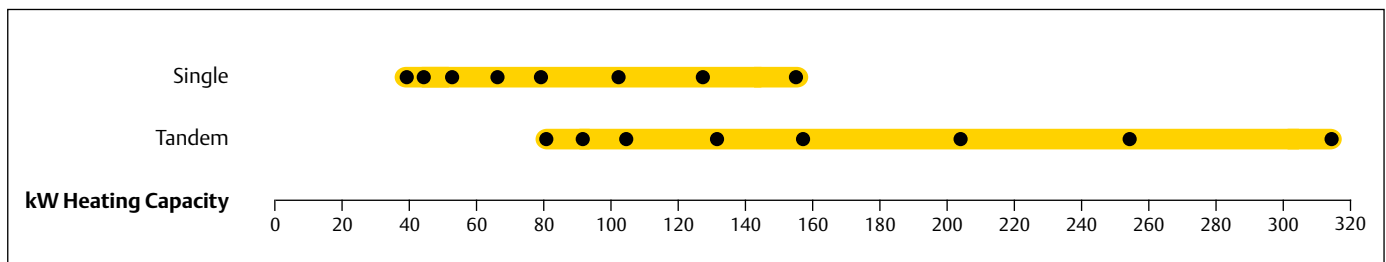

Conditions: Evaporating 40°C, Condensing 85°C, Superheat 10K, Subcooling 5K

Features and Benefits

- Copeland Scroll axial and radial compliance for superior reliability and efficiency
- Wide scroll line-up R134a with 8 models and tandem
- Low sound and vibration level
- Low oil circulation rate
- Copeland qualified tandem

Typical Applications

- Heat recovery on the dry cooler water circuit of a water-cooled chiller to produce sanitary water or other heating
- Re-inject energy to district heating network and avoid wasting it
- Process industry where the water returning from the machinery comes back between 20 and 40°C
- Food industry where one areas needs cooling and another heating at the same time
- Air-to-water heat pump, even during the warm season
- Exhaust air heat recovery system
- Heat recovery on Fluegas

Operating Envelope R134a

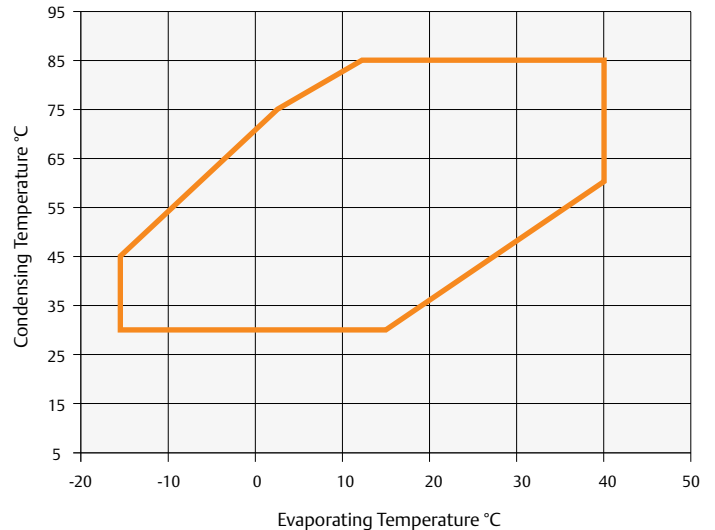

Maximum Allowable Pressure (PS)

Low Side PS 20 bar(g) / High Side PS 32 bar(g)

Technical Overview

Models	Nominal hp	Heating Capacity (kW)	COP	Displacement (m ³ /h)	Stub Suction (inch)	Stub Discharge (inch)	Oil Quantity (l)	Length/Width/Height (mm)	Net Weight (kg)	Motor Version / Code	Maximum Operating Current (A)	Locked Rotor Current (A)	Sound Pressure @1 m (dBA) **
										3 Ph*	3 Ph*	3 Ph*	
ZH40KCE	7.5	40.3	4.5	22.1	1 3/8	7/8	2.7	264 / 285 / 476	57	TFD	19.2	95	63
ZH45KCE	9.0	45.5	4.8	24.9	1 3/8	7/8	3.4	264 / 285 / 533	60	TFD	21.1	111	63
ZH50KCE	10.0	52.6	4.7	29.1	1 3/8	7/8	3.4	264 / 285 / 533	61	TFD	23.6	118	63
ZH64KCE	13.0	65.7	4.4	36.4	1 3/8	7/8	3.4	264 / 285 / 552	65	TFD	27.1	140	68
ZH75KCE	15.0	78.5	4.3	43.4	1 3/8	7/8	3.4	264 / 285 / 552	66	TFD	35.3	174	71
ZH100KCE	20.0	101.6	4.2	56.6	1 5/8	1 3/8	4.7	432 / 376 / 694	140	TWD	42.7	225	72
ZH125KCE	25.0	126.3	4.2	71.4	1 5/8	1 3/8	6.8	447 / 392 / 717	160	TWD	53.4	272	74
ZH150KCE	30.0	156.3	4.2	87.5	1 5/8	1 3/8	6.3	447 / 427 / 717	177	TWD	67.6	310	76

Conditions Evaporating 40°C - Condensing 85°C - Superheat 10K - Subcooling 5K

* 3 Ph: 380-420V/ 50Hz

** @ 1m: sound pressure level at 1m distance from the compressor, free field condition

Capacity Data

Condensing Temperature +80°C															
R134a		Heating Capacity (kW)						R134a		Power Input (kW)					
		Evaporating Temperature (°C)								Evaporating Temperature (°C)					
Models	+10	+15	+20	+25	+30	+35	+40	Models	+10	+15	+20	+25	+30	+35	+40
ZH40KCE	17.0	19.9	23.1	26.8	31.1	36.0	41.7	ZH40KCE	8.3	8.2	8.2	8.1	8.1	8.1	8.1
ZH45KCE	20.4	23.4	26.9	30.8	35.5	40.9	47.1	ZH45KCE	8.7	8.7	8.7	8.7	8.7	8.7	8.7
ZH50KCE	23.3	27.0	31.0	35.7	41.0	47.3	54.5	ZH50KCE	10.2	10.2	10.2	10.2	10.2	10.2	10.2
ZH64KCE	29.0	33.4	38.6	44.5	51.3	59.2	68.2	ZH64KCE	13.5	13.5	13.5	13.5	13.5	13.5	13.5
ZH75KCE	35.2	40.4	46.3	53.3	61.3	70.6	81.4	ZH75KCE	16.2	16.2	16.2	16.2	16.3	16.4	16.7
ZH100KCE	47.5	53.7	61.0	69.6	79.6	91.4	105.0	ZH100KCE	21.9	21.7	21.4	21.2	21.1	21.1	21.2
ZH125KCE	59.3	67.0	76.0	86.6	99.0	113.6	130.5	ZH125KCE	27.6	27.3	27.0	26.7	26.5	26.5	26.7
ZH150KCE	73.1	82.7	93.9	107.1	122.6	140.7	161.6	ZH150KCE	33.7	33.4	33.0	32.7	32.5	32.4	32.6

Conditions: Suction Superheat 5K / Subcooling 4K

ZRH Copeland Scroll™ Horizontal Compressor Range

for R407C and R134a, for the specific needs of transport air conditioning

Air conditioning for passenger comfort is a pre-requisite in today's public transport vehicles. At the same time, maximization of passenger space and streamlining of high speed trains increasingly impose limitations on height.

ZRH compressors are based on the unique Copeland Scroll design and provide the same reliability as a standard Copeland Scroll. The addition of an oil pump covers the specific needs of transport air conditioning and of horizontal compressor arrangement in general.

The low profile design and modulation capabilities of the ZRH compressor range are the ideal response to these market needs.



Horizontal Scroll Compressors

ZRH Scroll Compressors Line-up R407C and R134a

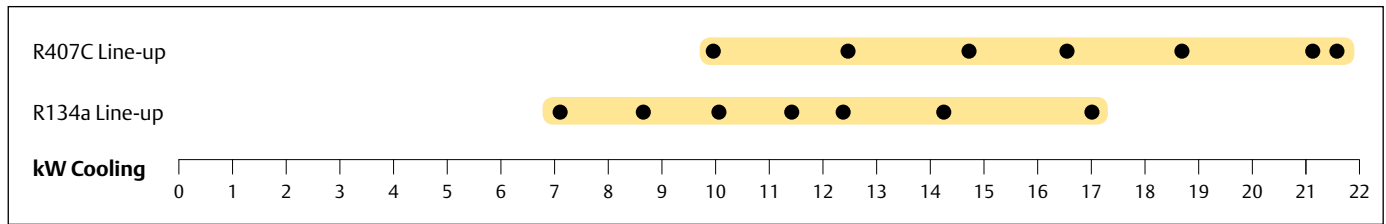

Conditions: EN12900: Evaporating 5°C, Condensing 50°C, Superheat 10K, Subcooling 0K

Features and Benefits

- Compactness and low weight
- Horizontal design with less than 250mm height
- Copeland Scroll compliance for superior reliability and efficiency
- Additional oil-pump
- Reduction of potential risk of refrigerant leakage through the drive shaft sealing
- Capacity modulation from 70% to 150% for Quest models ZRHV

Maximum Allowable Pressure (PS)

Low Side PS 21 bar(g) / High Side PS 28.8 bar(g)

Operating Envelope R407C

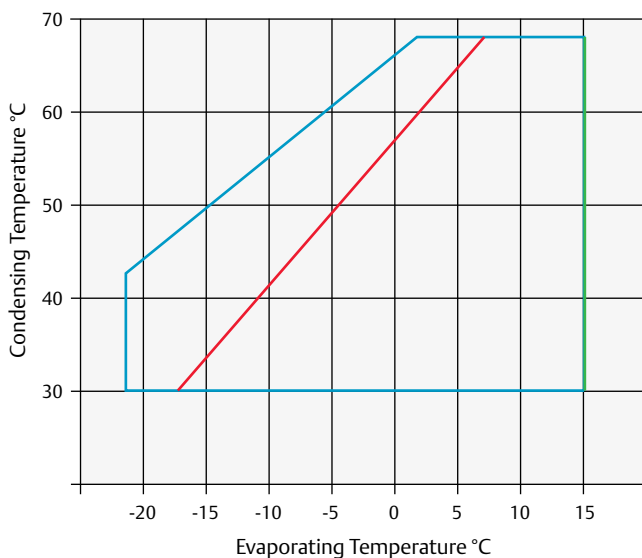

— 10K Suction Superheat — Maximum Evaporating Temperature
— 25°C Suction Gas Return

Operating Envelope R134a

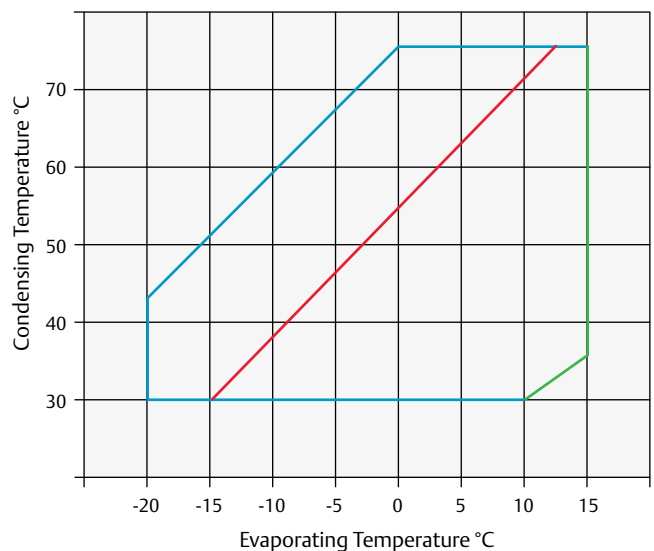

— 10K Suction Superheat — Maximum Evaporating Temperature
— 25°C Suction Gas Return

Technical Overview

Models	Nominal hp	Capacity (kW)	COP	Displacement (m ³ /h)	Stub Suction (inch)	Stub Discharge (inch)	Oil Quantity (l)	Length/Width/Height (mm)	Net Weight (kg)	Motor Version/ Code	Maximum Operating Current (A)	Locked Rotor Current (A)	Sound Pressure @ 1 m (dBA) **
										3 Ph*	3 Ph*	3 Ph*	
ZRH49KJE	4.0	9.9	2.9	11.8			1.8	487/290/245	52	TFD	9	52	68
ZRH61KJE	5.0	12.4	2.9	14.5			1.8	487/290/245	53	TFD	12	64	69
ZRH72KJE	6.0	14.8	2.8	17.1			1.8	487/290/245	53	TFD	12	74	66
ZRHV72KJE	6.0	14.8	2.8	17.1			1.8	487/290/245	53	TFD	15	100	66
ZRH78KTE	7.0	16.7	3.0	19.8	1 1/8	3/8	1.6	544/312/231	60	TFD	14	100	68
ZRH87KTE	7.5	18.8	3.0	22.1	1 1/8	3/8	1.6	544/312/231	60	TFD	16	95	63
ZRH100KTE	9.0	21.5	3.1	24.9	1 3/8	3/8	1.6	586/312/231	63	TFD	18	111	63
ZRH116KTE	10.0	25.1	3.1	29.1	1 3/8	3/8	1.6	586/312/231	64	TFD	20	118	63

Conditions: EN12900 R407C - HT: Evaporating +5°C, Condensing +50°C, Suction Superheat 10K, Subcooling 0K

*TFD: 3Ph 380-420V/50Hz - 460/60Hz; TF5 200-220V/50Hz, 200-230V/60Hz ** @ 1m: sound pressure level at 1m distance from the compressor, free field condition

Capacity Data

Condensing Temperature +50°C															
R134a		Cooling Capacity (kW)						R134a		Power Input (kW)					
		Evaporating Temperature (°C)								Evaporating Temperature (°C)					
Model	-20	-10	-5	0	+5	+10	+15	Model	-20	-10	-5	0	+5	+10	+15
ZRH49KJE		3.6	4.5	5.6	6.9	8.4	10.1	ZRH49KJE		1.9	2.0	2.1	2.1	2.2	2.3
ZRH61KJE		4.5	5.6	7.0	8.6	10.4	12.6	ZRH61KJE		2.3	2.4	2.5	2.6	2.8	2.9
ZRH72KJE		5.4	6.7	8.3	10.2	12.4	14.9	ZRH72KJE		2.8	3.0	3.1	3.3	3.4	3.6
ZRHV72KJE		5.4	6.7	8.3	10.2	12.4	14.9	ZRHV72KJE		2.8	3.0	3.1	3.3	3.4	3.6
ZRH78KTE		5.5	7.1	9.1	11.3	14.0	17.0	ZRH78KTE		3.7	3.7	3.8	3.8	3.9	4.0
ZRH87KTE		5.9	7.7	9.8	12.3	15.3	18.7	ZRH87KTE		4.0	4.1	4.1	4.1	4.1	4.1
ZRH100KTE		6.6	8.7	11.2	14.2	17.7	21.7	ZRH100KTE		4.4	4.5	4.5	4.5	4.5	4.6
ZRH116KTE		8.4	10.8	13.6	17.0	20.8	25.3	ZRH116KTE		5.6	5.6	5.6	5.5	5.5	5.5

Conditions: Suction Superheat 10K / Subcooling 0K

Condensing Temperature +50°C															
R407C		Cooling Capacity (kW)						R407C		Power Input (kW)					
		Evaporating Temperature (°C)								Evaporating Temperature (°C)					
Model	-20	-10	-5	0	+5	+10	+15	Model	-20	-10	-5	0	+5	+10	+15
ZRH49KJE		5.3	6.6	8.2	9.9	11.9	14.1	ZRH49KJE		2.9	3.1	3.3	3.5	3.7	3.9
ZRH61KJE		6.6	8.3	10.2	12.4	14.8	17.5	ZRH61KJE		3.6	3.8	4.1	4.3	4.6	4.9
ZRH72KJE		7.9	9.9	12.2	14.8	17.7	20.8	ZRH72KJE		4.5	4.8	5.0	5.3	5.6	5.9
ZRHV72KJE		7.9	9.9	12.2	14.8	17.7	20.8	ZRHV72KJE		4.5	4.8	5.0	5.3	5.6	5.9
ZRH78KTE				13.4	16.7	20.5		ZRH78KTE			5.4	5.5	5.5	5.5	
ZRH87KTE			11.6	14.9	18.8	23.5		ZRH87KTE			6.1	6.2	6.2	6.2	
ZRH100KTE			13.9	17.4	21.5	26.3		ZRH100KTE			6.7	6.8	6.9	6.9	
ZRH116KTE			16.1	20.2	25.1	30.8		ZRH116KTE			8.0	8.1	8.1	8.1	

Conditions: Suction Superheat 10K / Subcooling 0K



Refrigeration Applications

Emerson Climate Technologies offers a wide range of solutions for commercial refrigeration applications. With its long-lasting expertise in semi-hermetic reciprocating compressor technology as well as in scroll technology, we can meet the requirements for most applications - at the small end just like at the large end of commercial refrigeration.

Completed by the various offerings in the segment of condensing units, Emerson Climate Technologies is able to offer the best solution and performance, whether you are looking for applications in foodservice or processing, supermarkets, hypermarkets, petrol stations or refrigerated warehousing.

Emerson Climate Technologies' prime focus for its semi-hermetic reciprocating technology is at the large end of commercial refrigeration. Here aspects such as reliability, serviceability and capacity modulation are of importance and they are perfectly provided by Emerson Climate Technologies' semi-hermetic reciprocating compressors. Innovations like the Discus™ and Stream technologies, digital modulation and CoreSense™ Diagnostics for advanced protection and preventive maintenance keep semi-hermetic at the forefront of compressor technology.

Especially when compact equipment, energy efficiency and reliability are musts, the scroll technology is the preferred choice for refrigeration applications. With developments such as vapor injection and digital modulation, scroll has become the leading technology and is widely recognized in the refrigeration market.

CoreSense™ Diagnostics is now also available as an option for the new scroll Summit series for medium and low temperature applications.

Whatever the chosen technology and product solution, Emerson Climate Technologies' range meets the specific refrigeration needs covering the entire spectrum of medium and low temperature applications whether using standard HFCs, low GWP or natural refrigerants.

ZB Copeland Scroll™ Compressor Range for Medium Temperature Refrigeration

using R404A, R407F, R407A/C, R134a and R22

Emerson Climate Technologies offers ZB compressors with a wide displacement range from 5.9 m³/h to 87.5 m³/h. It includes digital compressor models that offer continuous capacity modulation technology.

Copeland Scroll compressors have 3 times less moving parts than reciprocating compressors and feature a scroll compliance mechanism which makes them particularly robust and reliable under severe conditions including liquid slugging.

They have the advantage of light weight and compactness, making them ideal for the usage in condensing units, compact refrigeration systems or special process units.

The Summit Series from 7 to 15 hp is designed to provide seasonal efficiencies 15% higher than traditional semi-hermetic compressors. These compressors are extremely quiet and can be fitted with an external sound shell for an additional 10 dBA sound reduction, which makes them best choice for refrigeration applications in urban and domestic areas.

The ZB range also features ZB220 (30hp), the largest refrigeration scroll available on the market. These compressors are qualified for R404A, R407F, R407A/C, R134a and R22. CoreSense™ Diagnostics is now available as an option for the ZB Scroll Summit series (ZB66K5E, ZB76K5E, ZB95K5E and ZB114K5E) as well as for Summit Digital ZBD.

For more details on Digital models please refer to page 50 in the catalogue.



ZB Compressor for Medium Temperature Refrigeration with and without Sound Shell

ZB and ZBD Compressor Line-up

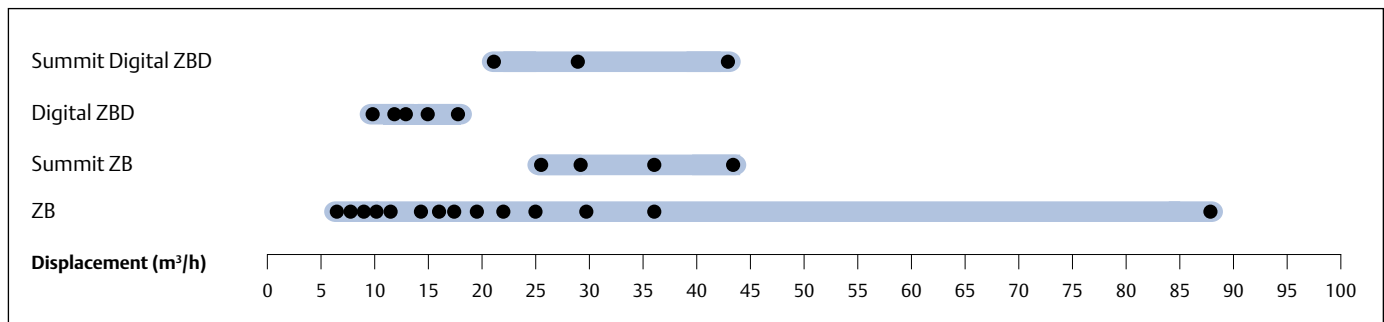

Features and Benefits

- Copeland Scroll axial and radial compliance for superior reliability and efficiency
- Wide operating envelope with 10°C condensing limit and fast pull-down capabilities
- High seasonal efficiencies as scrolls are designed at the condition where equipment runs most of the time
- Light weight and compactness, more than half the weight of equivalent semi-hermetic compressors
- Availability of optional sound shell on all models providing an additional 10 dBA sound attenuation for silent operation
- Includes 7 Digital Scroll compressor models for simple, stepless 10 to 100% capacity modulation
- One model for multiple refrigerants R404A, R407F, R407A/C, R134a and R22

Maximum Allowable Pressure (PS)

- ZB15 to ZB45:
Low Side PS 21 bar(g) / High Side PS 32 bar(g)
- ZB50 to ZB220:
Low Side PS 22.6 bar(g) / High Side PS 32 bar(g)
- Digital ZBD:
Low Side PS 21 bar(g) / High Side PS 28.8 bar(g)
- Summit ZBD:
Low Side PS 22.6 bar(g) / High Side PS 32 bar(g)

Operating Envelope R404A

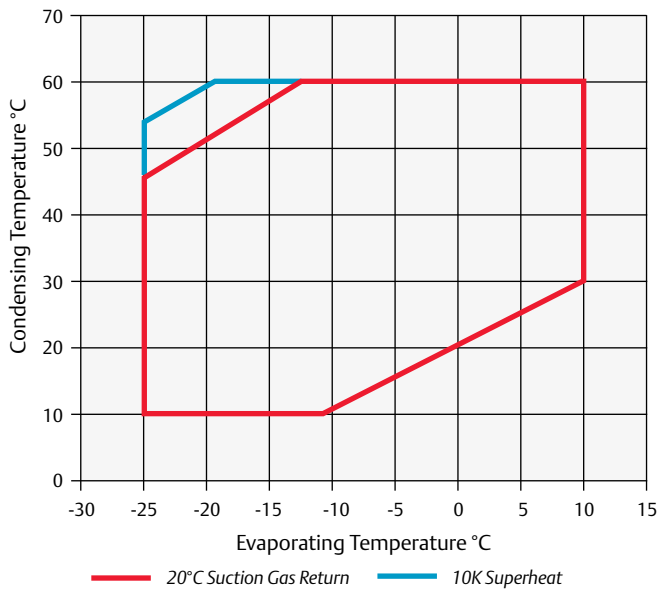

Operating Envelope R134a

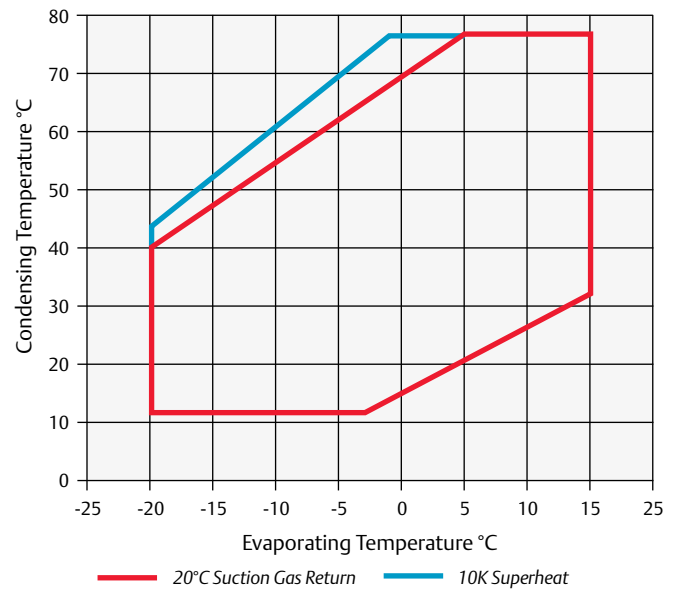

Operating Envelope R407A

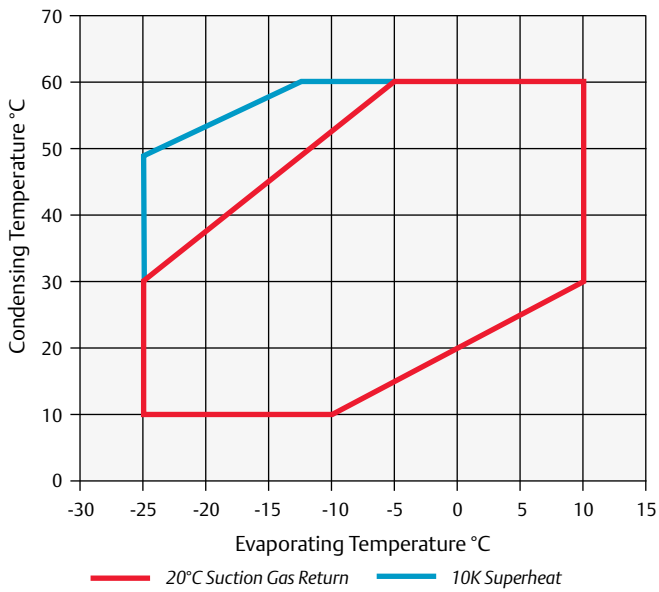

Operating Envelope R407C

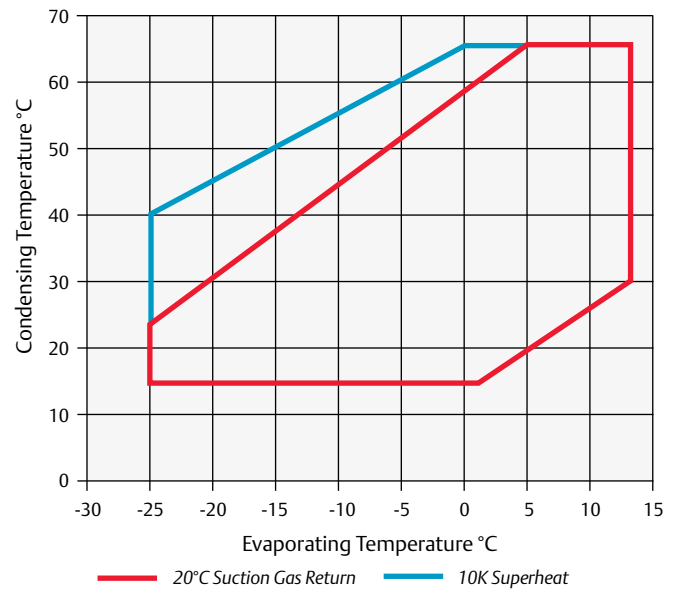

Operating Envelope R407F

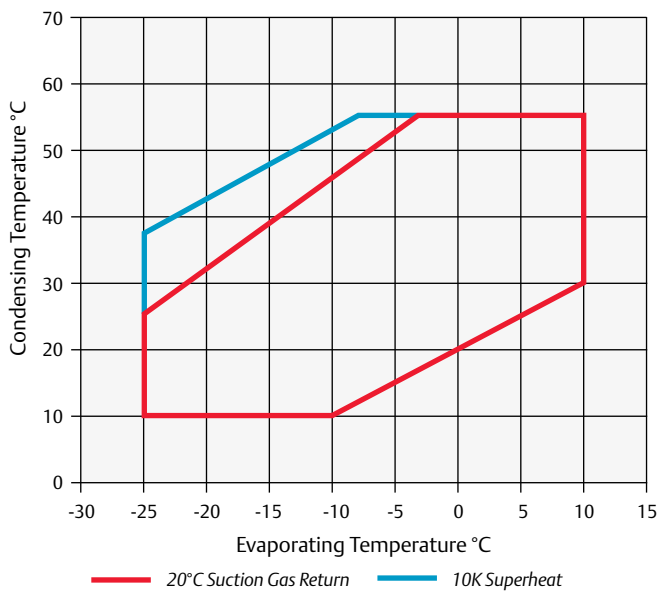

For individual model details please refer to Select Software.

Technical Overview

Models	Nominal hp	Displacement (m ³ /h)	Rotolock Suction (inch)	Rotolock Discharge (inch)	Oil Quantity (l)	Length/Width/Height (mm)	Net Weight (kg)	Motor Version/Code		Maximum Operating Current (A)		Locked Rotor Current (A)		Sound Pressure @1m (dBA)***
								1 Ph*	3 Ph**	1 Ph*	3 Ph**	1 Ph*	3 Ph**	
ZB15KCE	2.0	5.9	1.3	1.0	1.3	241/241/369	25.4	PFJ	TFD	12.8	4.9	58	26	55
ZB19KCE	2.5	6.8	1.3	1.0	1.5	242/242/369	27.2	PFJ	TFD	12.8	6.5	61	32	55
ZB21KCE	3.0	8.6	1.3	1.0	1.2	243/244/391	29.0	PFJ	TFD	16.4	7.2	82	40	58
ZB26KCE	3.5	10.0	1.3	1.0	1.5	243/244/405	28.0	PFJ	TFD	18.0	8.9	97	46	60
ZB29KCE	4.0	11.4	1.3	1.0	1.5	246/246/423	28.6		TFD		10.0		50	58
ZB30KCE	4.0	11.7	1.3	1.0	1.9	242/242/438	35.4	PFJ	TFD	26.4	10.3	142	49.3	61
ZB38KCE	5.0	14.4	1.3	1.0	1.9	242/242/438	37.4	PFJ	TFD	32.3	12.8	142	65.5	63
ZB42KCE	5.5	16.2	1.3	1.0	1.9	251/246/438	43.0	PFJ		35.7		150		62
ZB45KCE	6.0	17.1	1.3	1.0	1.9	242/242/438	39.5		TFD		13.1		74	61
ZB48KCE	6.5	18.8	1.3	1.3	1.8	246/250/442	39.0		TFD		14.0		101	62
ZB50KCE	6.5	19.8	1.3	1.0	2.7	246/284/480	59.0		TFD		14.6		100	64
ZB57KCE		21.4	1.3	1.3	1.9	246/256/442	39.5		TFD		15.9		102	65
ZB58KCE	8.0	22.1	1.8	1.3	2.5	264/284/476	57.2		TFD		15.6		95	65
ZB66KCE	9.0	24.9	1.8	1.3	3.3	264/284/533	59.9		TFD		17.5		111	66
ZB76KCE	10.0	29.1	1.8	1.3	3.3	264/284/533	61.2		TFD		20.4		118	66
ZB95KCE	13.0	36.4	1.8	1.3	3.3	264/285/552	64.9		TFD		28.2		140	67
ZB114KCE	15.0	43.4	1.8	1.3	3.3	264/285/552	66.0		TFD		33.0		174	71
ZB220KCE	30.0	87.5	2 ¼ x 12 UN	1 ¾ x 12 UN	6.3	448/392/715	176.0		TWM		69.0		310	78
ZB Summit Models														
ZB66K5E	10.0	25.7	1.8	1.3	3.4	280/280/534	59.9		TFD		17.5		111	66
ZB76K5E	12.0	28.8	1.8	1.3	3.4	280/280/534	61.2		TFD		20.4		118	67
ZB95K5E	13.0	36.4	1.8	1.3	3.4	280/280/552	64.9		TFD		28.2		140	69
ZB114K5E	15.0	43.4	1.8	1.3	3.4	280/280/552	66.2		TFD		33.5		174	72

* 1 Ph: 230V/ 50Hz

** 3 Ph: 380-420V/ 50Hz

*** @ 1m: sound pressure level at 1m distance from the compressor, free field condition

Capacity Data

Condensing Temperature: 40°C															
R134A	Cooling Capacity (kW)							R134A	Power Input (kW)						
	Evaporating Temperature (°C)								Evaporating Temperature (°C)						
Models	-35	-30	-25	-20	-15	-10	-5	Models	-35	-30	-25	-20	-15	-10	-5
ZB15KCE				1.4	1.7	2.2	2.7	ZB15KCE				0.9	0.9	0.9	1.0
ZB19KCE				1.6	2.0	2.5	3.2	ZB19KCE				1.1	1.1	1.1	1.1
ZB21KCE				2.0	2.5	3.2	4.0	ZB21KCE				1.3	1.3	1.3	1.3
ZB26KCE				2.3	2.9	3.7	4.6	ZB26KCE				1.5	1.5	1.5	1.5
ZB29KCE				2.7	3.4	4.3	5.4	ZB29KCE				1.7	1.7	1.8	1.8
ZB30KCE				2.7	3.4	4.3	5.4	ZB30KCE				1.7	1.7	1.7	1.8
ZB38KCE				3.2	4.2	5.4	6.7	ZB38KCE				2.1	2.1	2.1	2.2
ZB42KCE**				3.8	4.8	6.0	7.5	ZB42KCE**				2.5	2.5	2.5	2.4
ZB45KCE				4.0	5.1	6.4	8.0	ZB45KCE				2.4	2.4	2.5	2.5
ZB48KCE				4.8	6.0	7.5	9.1	ZB48KCE				2.8	2.8	2.9	2.9
ZB50KCE				4.6	5.9	7.4	9.1	ZB50KCE				3.0	3.0	3.0	3.1
ZB57KCE				4.7*	6.4	8.1	10.1	ZB57KCE				3.4*	3.4	3.4	3.5
ZB58KCE				5.2	6.6	8.3	10.3	ZB58KCE				3.4	3.4	3.4	3.4
ZB66KCE				6.0	7.5	9.5	11.8	ZB66KCE				3.8	3.7	3.8	3.8
ZB76KCE				6.9	8.6	10.9	13.5	ZB76KCE				4.4	4.4	4.4	4.5
ZB95KCE				8.2	10.8	13.8	17.1	ZB95KCE				5.4	5.5	5.6	5.6
ZB114KCE				9.6	12.7	16.3	20.4	ZB114KCE				6.6	6.6	6.6	6.7
ZB220KCE					27.3	34.1	42.1	ZB220KCE					13.0	13.2	13.5
ZB Summit Models															
ZB66K5E				6.0	7.6	9.5	11.8	ZB66K5E				3.8	3.7	3.8	3.8
ZB76K5E				6.9	8.6	10.8	13.5	ZB76K5E				4.4	4.4	4.4	4.5
ZB95K5E				8.2	10.8	13.8	17.1	ZB95K5E				5.4	5.5	5.6	5.6
ZB114K5E				9.6	12.7	16.3	20.4	ZB114K5E				6.6	6.6	6.7	6.7

Suction Gas Return 20°C

* 10K border

**only 230V

Preliminary data

Capacity Data

Condensing Temperature: 40°C															
R407A	Cooling Capacity (kW)							R407A	Power Input (kW)						
	Evaporating Temperature (°C)								Evaporating Temperature (°C)						
Models	-35	-30	-25	-20	-15	-10	-5	Models	-35	-30	-25	-20	-15	-10	-5
ZB15KCE				2.1*	2.8	3.5	4.2	ZB15KCE				1.5*	1.5	1.5	1.5
ZB19KCE				2.6*	3.4	4.2	5.2	ZB19KCE				1.7*	1.8	1.8	1.8
ZB21KCE				3.2*	4.1	5.1	6.2	ZB21KCE				2.1*	2.1	2.1	2.1
ZB26KCE				3.6*	4.7	5.8	7.1	ZB26KCE				2.3*	2.3	2.3	2.4
ZB29KCE			2.9*	4.0*	5.3	6.6	8.0	ZB29KCE			2.7*	2.7*	2.7	2.7	2.7
ZB30KCE				4.4*	5.8	7.3	8.9	ZB30KCE				2.7*	2.7	2.7	2.8
ZB38KCE				5.4*	7.2	8.9	11.0	ZB38KCE				3.2*	3.3	3.3	3.4
ZB42KCE**				6.1*	7.9	9.8	12.0	ZB42KCE**				3.9*	3.9	3.9	3.9
ZB45KCE				6.3*	8.2	10.2	12.4	ZB45KCE				3.9*	4.0	4.0	4.0
ZB48KCE			5.4*	6.9*	9.1	11.2	13.7	ZB48KCE			4.2*	4.3*	4.4	4.4	4.4
ZB57KCE			6.5*	8.7	11.1	13.8	17.0	ZB57KCE			5.2*	5.2	5.2	5.3	5.3
ZB58KCE				7.2*	10.1	13.0	16.2	ZB58KCE				5.1*	5.2	5.2	5.3
ZB66KCE				8.5*	11.6	14.7	18.3	ZB66KCE				5.7*	5.8	5.9	6.0
ZB76KCE				10.1*	13.7	17.4	21.6	ZB76KCE				6.5*	6.7	6.8	6.9
ZB95KCE				12.0*	16.7	21.2	26.4	ZB95KCE				8.6*	8.7	8.8	8.9
ZB56KCE				7.4*	9.7	12.0	14.6	ZB56KCE				5.0*	5.1	5.2	5.2
ZB75KCE				10.9*	14.2	17.4	21.1	ZB75KCE				6.2*	6.5	6.7	6.9
ZB92KCE				13.6*	17.6	21.5	26.2	ZB92KCE				8.0*	8.3	8.6	8.8
ZB Summit Models - with Liquid Injection															
ZB66K5E				9.2*	12.4	15.6	19.3	ZB66K5E				5.5*	5.6	5.7	5.8
ZB76K5E				10.6*	14.2	18.1	22.4	ZB76K5E				6.5*	6.5	6.7	6.9
ZB95K5E				12.9*	17.7	22.5	27.8	ZB95K5E				8.3*	8.3	8.5	8.7
ZB114K5E				14.8*	20.5	26.3	32.8	ZB114K5E				10.2*	10.2	10.3	10.5

Suction Gas Return 20°C

* 10K border

** only 230V

Preliminary data

Capacity Data

Condensing Temperature: 40°C															
R407F	Cooling Capacity (kW)							R407F	Power Input (kW)						
	Evaporating Temperature (°C)								Evaporating Temperature (°C)						
Models	-35	-30	-25	-20	-15	-10	-5	Models	-35	-30	-25	-20	-15	-10	-5
ZB15KCE					2.6*	3.4	4.2	ZB15KCE					1.6*	1.6	1.6
ZB19KCE					3.2*	4.2	5.1	ZB19KCE					1.9*	1.9	1.9
ZB21KCE					3.9*	5.1	6.2	ZB21KCE					2.2*	2.2	2.3
ZB26KCE					4.5*	5.8	7.2	ZB26KCE					2.6*	2.6	2.6
ZB29KCE					5.4*	7.0	8.7	ZB29KCE					2.8*	2.9	2.8
ZB30KCE				4.2*	5.5*	7.2	8.9	ZB30KCE				2.9*	2.9*	2.9	2.9
ZB38KCE				5.2*	6.9*	8.9	11.0	ZB38KCE				3.7*	3.7*	3.7	3.7
ZB45KCE				6.0*	8.1*	10.5	13.0	ZB45KCE				4.1*	4.2*	4.3	4.2
ZB48KCE				6.6*	8.9*	11.6	14.3	ZB48KCE				4.5*	4.7*	4.7	4.7
ZB57KCE				8.5*	10.8*	13.8	17.0	ZB57KCE				5.2*	5.2*	5.3	5.3
ZB58KCE				7.5*	10.6*	14.1	17.6	ZB58KCE				5.4*	5.5*	5.5	5.5
ZB66KCE				8.9*	12.2*	15.9	19.8	ZB66KCE				6.*	6.1*	6.2	6.2
ZB76KCE				10.5*	14.4*	18.8	23.3	ZB76KCE				6.9*	7.0*	7.1	7.2
ZB95KCE				12.4*	17.5*	23.1	28.7	ZB95KCE				8.9*	9.0*	9.2	9.3
ZB114KCE				14.5*	20.6*	27.5	34.4	ZB114KCE				10.8*	10.9*	11.0	11.1
ZB Summit Models															
ZB66K5E				9.3*	12.1*	15.6	19.3	ZB66K5E				5.5*	5.6*	5.7	5.8
ZB76K5E				10.7*	13.9*	18.0	22.4	ZB76K5E				6.5*	6.5*	6.7	6.9
ZB95K5E				13.0*	17.3*	22.4	27.8	ZB95K5E				8.3*	8.3*	8.5	8.7
ZB114K5E				14.9*	20.0*	26.3	32.7	ZB114K5E				10.2*	10.2*	10.3	10.5

Suction Gas Return 20°C

* 10K border

** only 230V

Preliminary data

Capacity Data

Condensing Temperature: 40°C															
R404A	Cooling Capacity (kW)							R404A	Power Input (kW)						
	Evaporating Temperature (°C)								Evaporating Temperature (°C)						
Models	-35	-30	-25	-20	-15	-10	-5	Models	-35	-30	-25	-20	-15	-10	-5
ZB15KCE			1.9	2.4	3.0	3.7	4.5	ZB15KCE			1.7	1.7	1.6	1.6	1.5
ZB19KCE			2.3	2.9	3.5	4.2	5.1	ZB19KCE			1.9	1.9	1.9	1.9	1.9
ZB21KCE			3.0	3.7	4.5	5.5	6.6	ZB21KCE			2.2	2.2	2.2	2.2	2.2
ZB26KCE			3.5	4.3	5.3	6.4	7.6	ZB26KCE			2.6	2.6	2.6	2.6	2.6
ZB29KCE			4.1	5.1	6.3	7.6	9.1	ZB29KCE			2.9	2.9	2.9	2.9	2.8
ZB30KCE			4.1	5.0	6.2	7.5	9.0	ZB30KCE			3.0	3.0	3.0	3.0	3.0
ZB38KCE			5.1	6.3	7.7	9.3	11.2	ZB38KCE			3.8	3.8	3.8	3.8	3.8
ZB42KCE**			5.7	7.1	8.7	10.6	12.7	ZB42KCE**			4.2	4.2	4.2	4.2	4.2
ZB45KCE			6.0	7.4	9.1	11.0	13.2	ZB45KCE			4.3	4.3	4.3	4.3	4.3
ZB48KCE			6.9	8.6	10.5	12.7	15.2	ZB48KCE			4.9	4.9	4.9	4.9	4.9
ZB50KCE				6.6*	9.1	11.5	14.4	ZB50KCE				5.2	5.1	5.1	5.1
ZB57KCE			7.9	9.7	11.9	14.3	17.1	ZB57KCE			4.7	4.9	5.2	5.4	5.5
ZB58KCE			7.2	9.4	11.9	14.5	17.5	ZB58KCE			5.6	5.6	5.6	5.7	5.7
ZB66KCE			8.9	11.1	13.6	16.4	19.7	ZB66KCE			6.2	6.3	6.3	6.4	6.4
ZB76KCE			10.4	13.0	16.0	19.4	23.3	ZB76KCE			7.1	7.2	7.3	7.3	7.4
ZB95KCE			10.7*	15.6	19.5	23.8	28.7	ZB95KCE			9.4*	9.4	9.3	9.4	9.5
ZB114KCE				12.3*	18.3	28.3	34.4	ZB114KCE				11.4*	11.3	11.3	11.4
ZB220KCE			28.5*	39.2	47.7	57.5	68.9	ZB220KCE			21.4*	21.8	22.0	22.2	22.4
ZB Summit Models															
ZB66K5E			9.1	11.4	13.9	16.8	20.1	ZB66K5E			6.2	6.2	6.2	6.3	6.4
ZB76K5E			10.5	13.1	16.2	19.7	23.6	ZB76K5E			7.2	7.2	7.3	7.4	7.5
ZB95K5E			10.7*	16.0	20.1	24.5	29.3	ZB95K5E			9.3*	9.2	9.3	9.3	9.4
ZB114K5E			12.5*	18.7	23.4	28.7	34.7	ZB114K5E			11.3*	11.3	11.3	11.4	11.4

Suction Gas Return 20°C

* 10K border

**only 230V

Preliminary data

Capacity Data

Condensing Temperature: 40°C															
R407C	Cooling Capacity (kW)							R407C	Power Input (kW)						
	Evaporating Temperature (°C)								Evaporating Temperature (°C)						
Models	-35	-30	-25	-20	-15	-10	-5	Models	-35	-30	-25	-20	-15	-10	-5
ZB15KCE			1.3*	1.8*	2.4*	3.2	4.0	ZB15KCE			1.4*	1.4*	1.4*	1.4	1.3
ZB19KCE			1.6*	2.1*	2.7*	3.5	4.4	ZB19KCE			1.6*	1.6*	1.6*	1.6	1.6
ZB21KCE			2.1*	2.9*	3.7*	4.7	5.9	ZB21KCE			1.9*	1.9*	1.9*	1.9	1.9
ZB26KCE			2.5*	3.3*	4.3*	5.5	6.9	ZB26KCE			2.2*	2.2*	2.2*	2.2	2.2
ZB29KCE			3.2*	4.2*	5.3*	6.7	8.2	ZB29KCE			2.2*	2.3*	2.4*	2.5	2.6
ZB30KCE			3.4*	4.2*	5.3*	6.6	8.1	ZB30KCE			2.4*	2.5*	2.6*	2.7	2.7
ZB38KCE			3.8*	5.2*	6.6*	8.3	10.1	ZB38KCE			3.2*	3.1*	3.1*	3.2	3.2
ZB42KCE**			4.4*	5.7*	7.2*	9.1	11.2	ZB42KCE**			3.8*	3.8*	3.8*	3.8	3.6
ZB45KCE			4.5*	5.8*	7.5*	9.6	11.9	ZB45KCE			3.6*	3.6*	3.6*	3.7	3.7
ZB48KCE			3.4*	5.3*	7.4*	9.9	12.5	ZB48KCE			4.0*	4.0*	4.1*	4.1	4.1
ZB50KCE				6.3*	8.7	11.0	13.5	ZB50KCE				4.4*	4.4	4.4	4.4
ZB57KCE			5.0*	6.9	8.9	11.3	14.1	ZB57KCE			4.5*	4.6	4.8	4.8	4.9
ZB58KCE				7.5*	10.2	12.8	15.7	ZB58KCE				4.9*	4.9	5.0	5.0
ZB66KCE				9.1*	11.7	14.4	17.6	ZB66KCE				5.3*	5.4	5.4	5.4
ZB76KCE				10.3*	13.5	16.7	20.5	ZB76KCE				6.2*	6.3	6.3	6.4
ZB95KCE				11.2*	15.5	19.8	24.9	ZB95KCE				8.0*	8.0	8.1	8.2
ZB114KCE				12.3*	18.3	28.3	34.4	ZB114KCE				9.6*	9.7	9.7	9.8
ZB Summit Models															
ZB66K5E				9.4*	12.1	14.9	18.2	ZB66K5E				5.2*	5.3	5.3	5.3
ZB76K5E				10.4*	13.6	16.9	20.8	ZB76K5E				6.2*	6.3	6.3	6.3
ZB95K5E				11.5*	15.8	20.2	25.5	ZB95K5E				7.8*	7.9	7.9	8.0
ZB114K5E				14.2*	19.2	24.3	30.0	ZB114K5E				9.6*	9.7	9.8	9.8

Suction Gas Return 20°C
 * 10K border
 ** only 230V
 Preliminary data

Condensing Temperature: 40°C															
R22	Cooling Capacity (kW)							R22	Power Input (kW)						
	Evaporating Temperature (°C)								Evaporating Temperature (°C)						
Models	-35	-30	-25	-20	-15	-10	-5	Models	-35	-30	-25	-20	-15	-10	-5
ZB15KCE			1.4*	2.1*	2.7*	3.5	4.2	ZB15KCE			1.5*	1.4*	1.4*	1.4	1.4
ZB19KCE			1.9*	2.5*	3.2*	4.0	4.8	ZB19KCE			1.6*	1.6*	1.6*	1.6	1.6
ZB21KCE			2.0*	3.0*	4.0*	5.1	6.2	ZB21KCE			2.2*	2.1*	2.0*	2.0	2.0
ZB26KCE			2.7*	3.5*	4.4*	5.6	6.8	ZB26KCE			2.2*	2.2*	2.2*	2.2	2.2
ZB30KCE			2.2*	3.2*	4.5*	6.0	7.7	ZB30KCE			2.6*	2.7*	2.7*	2.7	2.7
ZB38KCE			3.8*	4.9*	6.3*	8.0	10.0	ZB38KCE			2.9*	3.0*	3.1*	3.1	3.2
ZB42KCE**			5.2*	6.6*	8.1*	9.9	11.9	ZB42KCE**			3.9*	3.8*	3.8*	3.7	3.6
ZB45KCE			4.5*	6.4*	8.3*	10.3	12.5	ZB45KCE			3.4*	3.6*	3.7*	3.7	3.8
ZB48KCE			5.5*	6.9*	8.8*	11.1	13.7	ZB48KCE			4.0*	4.1*	4.1*	4.2	4.2
ZB50KCE				9.2*	10.7	14.4	17.4	ZB50KCE				5.2	5.1	5.1	5.1
ZB58KCE			5.1*	7.5*	10.1*	13.0	16.1	ZB58KCE			4.8*	4.9*	4.9*	4.9	4.9
ZB66KCE			7.4*	9.7*	12.2*	15.1	18.4	ZB66KCE			5.1*	5.2*	5.3*	5.4	5.4
ZB76KCE			8.9*	11.5*	14.4*	17.8	21.7	ZB76KCE			5.9*	6.1*	6.2*	6.3	6.4
ZB95KCE					16.8*	21.4*	26.5*	ZB95KCE					8.0*	8.1*	8.2*
ZB56KCE			6.6*	8.2*	10.2*	12.5	15.1	ZB56KCE			4.5*	4.7*	4.9*	5.1	5.2
ZB75KCE			8.8*	11.1*	13.7*	16.8	20.3	ZB75KCE			6.3*	6.6*	6.8*	7.1	7.3
ZB92KCE			11.3*	14.1*	17.4*	21.3	25.7	ZB92KCE			7.5*	7.8*	8.1*	8.4	8.7
ZB114KCE					19.9*	25.5*	3.7*	ZB114KCE					9.6*	9.6*	9.7*

Suction Gas Return 20°C
 * 10K border
 ** only 230V

ZF Copeland Scroll™ Compressor Range for Low Temperature Refrigeration using R404A, R407F, R407A and R22

Emerson Climate Technologies developed the ZF range to provide the best performance in low temperature. The range has a wide application envelope as it can operate from -40°C evaporating temperature to +7°C. They have been optimized in their design to perfectly fit frozen food application requirements. Thanks to their scroll compliance mechanism, these scroll compressors feature particularly high tolerance to liquid slugging.

The range consists of:

- The ZF*KCE models that operate with liquid injection in order to control discharge temperature and increase the operating envelope.
- The ZF*KVE models that are optimized for vapor injection with use of a sub-cooler. This boosts refrigeration system's cooling capacity and efficiency.
- The Summit ZF* K5E models that operate both with liquid injection or vapor injection.

These compressors are qualified for R404A, R407F, R407A, R507, R22 and R134a for certain models. For more details on Digital Scroll models please refer to page 44 in the catalogue.

CoreSense™ Diagnostics is now available as an option for the ZF Scroll Summit series (ZF34K5E-ZF49K5E) as well as for Summit Digital ZFD41K5E.



ZF Compressor for Low Temperature Refrigeration with and without Sound Shell

ZF and ZFD Compressor Line-up

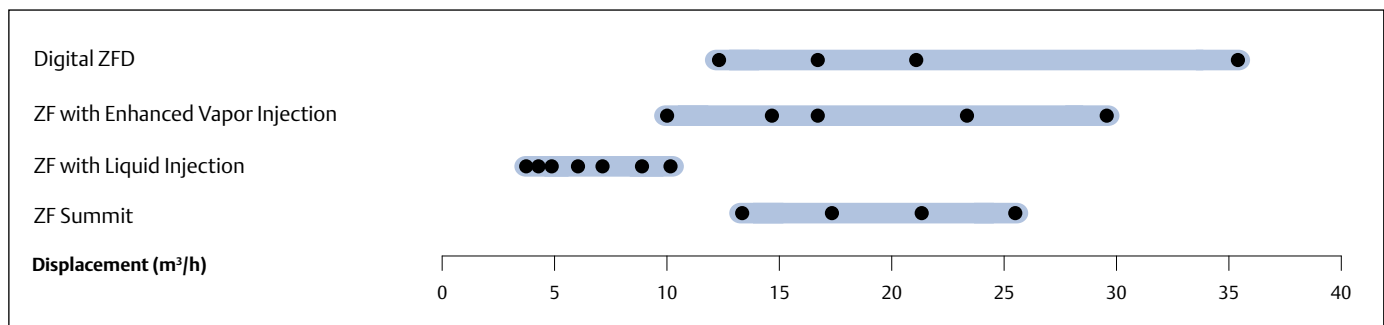

Features and Benefits

- Wide operating envelope with 10°C low condensing temperature to minimize energy consumption
- One model for multiple refrigerants
- Light weight and compactness, more than half the weight of equivalent semi-hermetic compressor
- Optional Sound Shell allowing 10 dBA sound attenuation
- ZF models with liquid injection
 - Easy, efficient and reliable injection via Discharge Temperature Control Valve (DTC) on the smaller models
- ZF models with Enhanced Vapor Injection
 - Seasonal efficiencies compared to Emerson's best semi-hermetic compressors
 - Improved system capacity and efficiency by 40% and 25% respectively, making them the most efficient compressors on the market.
 - Possibility to reduce the equipment and component sizes by using smaller compressors

Maximum Allowable Pressure (PS)

- ZF06 to ZF18 (K4E/KVE):
Low Side PS 21 bar(g) / High Side PS 32 bar(g)
- ZF24 to ZF48 (K4E/KVE/K5E):
Low Side PS 22.6 bar(g) / High Side PS 32 bar(g)
- Digital ZFD:
Low Side PS 19 bar(g) / High Side PS 28 bar(g)

Operating Envelope R404A - For Vapor Injection

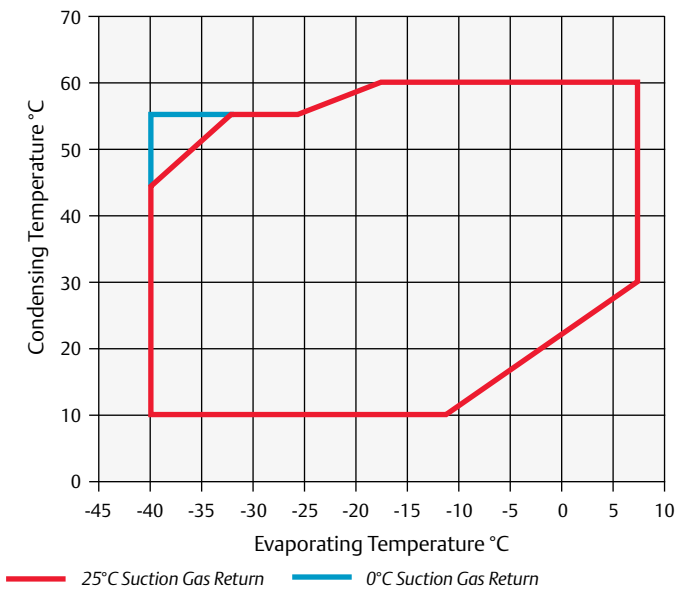

For Liquid Injection

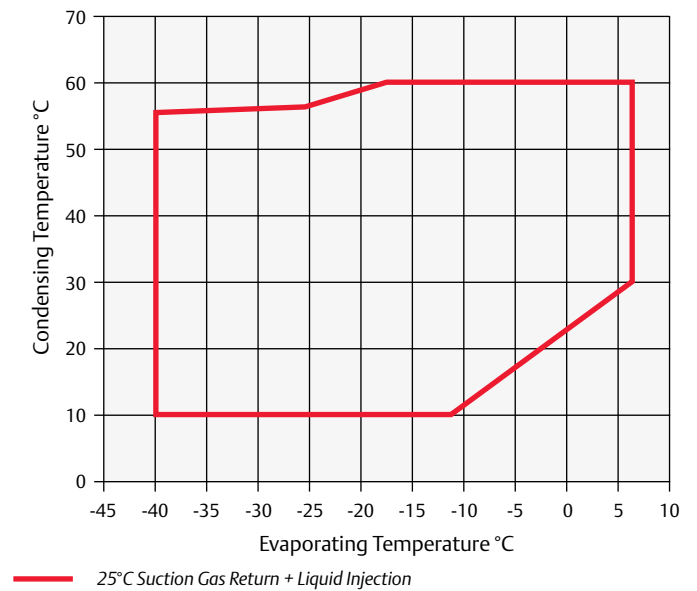

Operating Envelope R407A - For Vapor Injection

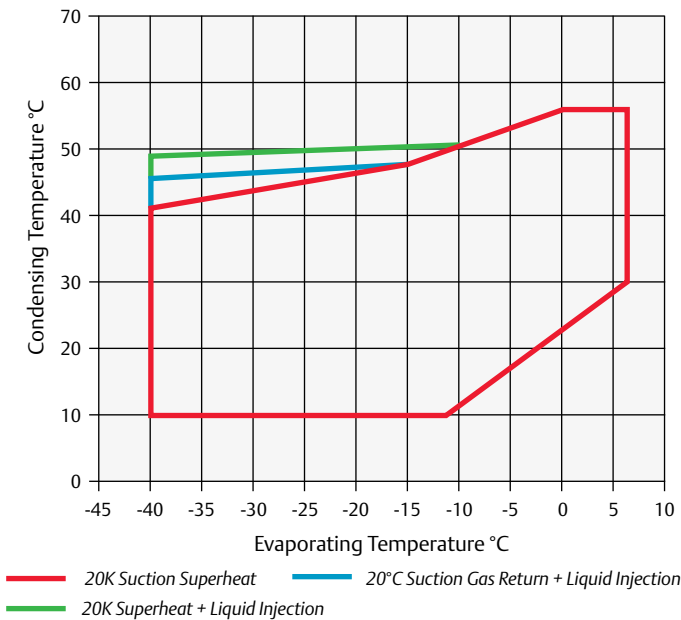

For Liquid Injection

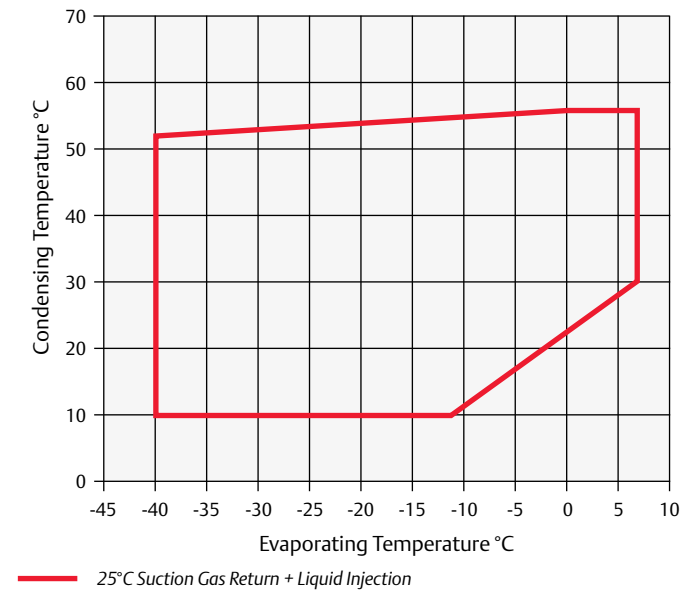

Operating Envelope R407F - For Vapor Injection

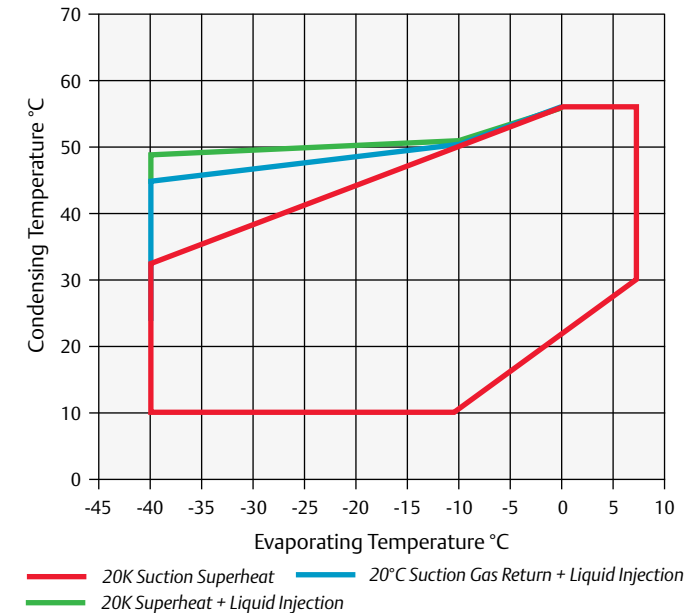

For Liquid Injection

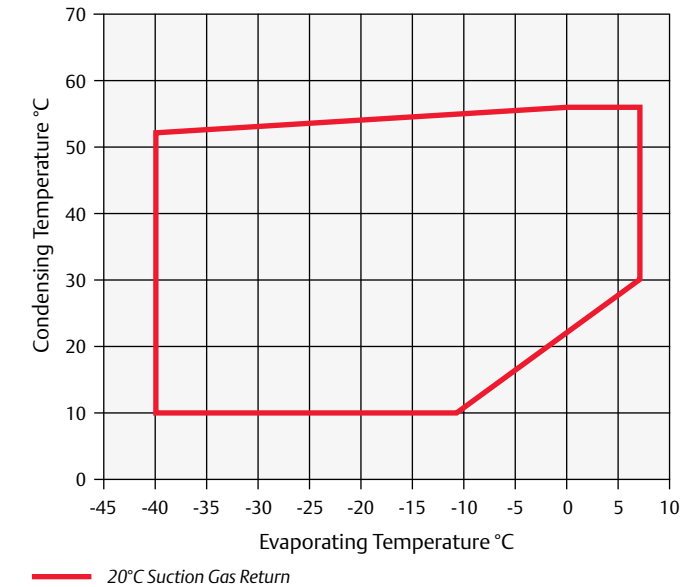

For individual model details please refer to Select Software.

Technical Overview

Models	Nominal hp	Displacement (m ³ /h)	Rota Suction (inch)	Rota Discharge (inch)	Oil Quantity (l)	Length/Width/Height (mm)	Net Weight (kg)	Motor Version/ Code	Maximum Operating Current (A)	Locked Rotor Current (A)	Sound Pressure @ 1 m (dBA) ***
								3 Ph **	3 Ph **	3 Ph **	
Models with Liquid Injection											
ZF06K4E	2.0	3.5	1.3	1.0	1.3	243/245/369	25.4	TFD	5	26	57.0
ZF08K4E	2.5	4.5	1.3	1.0	1.5	243/245/391	27.2	TFD	6	32	59.0
ZF09K4E	2.8	4.8	1.3	1.0	1.5	243/244/391	27.0	TFD	6	40	62.0
ZF11K4E	3.5	6.0	1.3	1.0	1.5	243/244/405	28.0	TFD	7	46	63.0
ZF13K4E	4.0	7.1	1.3	1.0	1.9	246/251/442	38.0	TFD	8	52	65.0
ZF15K4E	5.0	8.6	1.3	1.0	1.9	246/251/442	39.0	TFD	10	64	65.0
ZF18K4E	6.0	10.4	1.3	1.0	1.9	246/251/442	41.0	TFD	13	74	67.0
ZF Summit Models - with Liquid Injection											
ZF25K5E	7.5	13.0	1.3	1.3	1.9	246/257/452	39.5	TFD	14	102	71.0
ZF34K5E		17.2	1.8	1.3	3.4	280/280/534	63.1	TFD	25	100	63.0
ZF41K5E		21.3	1.8	1.3	3.4	280/280/534	63.1	TFD	29	118	63.0
ZF49K5E		25.7	1.8	1.3	3.4	280/280/552	66.2	TFD	30	139	71.0
Models with Enhanced Vapor Injection											
ZF13KVE EVI	4.0	9.7	1.3	1.0	1.4	246/251/442	38.0	TFD	9	52	63.0
ZF18KVE EVI	6.0	14.1	1.3	1.0	1.9	246/251/442	39.5	TFD	14	74	67.0
ZF25K5E EVI	7.5	16.9	1.3	1.3	1.9	246/257/452	39.5	TFD	16	102	70.0
ZF34K5E EVI		23.5	1.8	1.3	3.4	280/280/534	63.1	TFD	25	100	72.0
ZF41K5E EVI		29.1	1.8	1.3	3.4	280/280/534	63.1	TFD	29	118	72.0

** 3 Ph: 380-420V/ 50Hz

*** @ 1m: sound pressure level at 1m distance from the compressor, free field condition

Capacity Data

Condensing Temperature: 40°C															
R407F	Cooling Capacity (kW)							R407F	Power Input (kW)						
	Evaporating Temperature (°C)								Evaporating Temperature (°C)						
Models	-35	-30	-25	-20	-15	-10	-5	Models	-35	-30	-25	-20	-15	-10	-5
Models with Enhanced Vapor Injection															
ZF13KVE EVI	3,3	4,3	5,4	6,7	8,1	9,7	11,5	ZF13KVE EVI	2,8	2,9	3,0	3,0	3,1	3,2	3,3
ZF18KVE EVI	4,9	6,1	7,6	9,3	11,3	13,5	16,0	ZF18KVE EVI	3,8	4,0	4,1	4,2	4,4	4,6	4,7
ZF25K5E EVI	6,4	8,0	9,9	11,9	14,2	16,6	19,1	ZF25K5E EVI	4,5	4,7	4,9	5,1	5,3	5,5	5,8
ZF34K5E EVI	8,4	10,4	12,7	15,4	18,4	21,7	25,4	ZF34K5E EVI	5,6	5,8	6,0	6,2	6,4	6,6	6,8
ZF41K5E EVI	10,6	13,3	16,3	19,6	23,2	27,1	31,2	ZF41K5E EVI	7,1	7,3	7,5	7,7	8,0	8,2	8,4
ZF49K5E EVI	12,7	15,8	19,4	23,5	28,1			ZF49K5E EVI	8,4	8,7	9,0	9,3	9,5		
Models with Liquid Injection															
ZF06K4E	1,2	1,6	2,0	2,4	3,0	3,7	4,4	ZF06K4E	1,3	1,3	1,3	1,4	1,4	1,5	1,6
ZF08K4E	1,5	2,0	2,5	3,1	3,8	4,6	5,6	ZF08K4E	1,5	1,5	1,6	1,6	1,7	1,8	1,9
ZF09K4E	1,7	2,1	2,7	3,4	4,2	5,1	6,2	ZF09K4E	1,6	1,6	1,6	1,7	1,8	1,9	2,0
ZF11K4E	2,1	2,7	3,4	4,2	5,2	6,3	7,7	ZF11K4E	2,0	2,0	2,0	2,1	2,2	2,3	2,4
ZF13K4E	2,4	3,0	3,8	4,7	5,9	7,2	8,7	ZF13K4E	2,4	2,4	2,5	2,6	2,7	2,8	2,9
ZF15K4E	2,9	3,7	4,7	5,8	7,2	8,8	10,8	ZF15K4E	2,8	3,0	3,1	3,2	3,4	3,5	3,8
ZF18K4E	3,5	4,5	5,7	7,1	8,7	10,7	13,0	ZF18K4E	3,5	3,6	3,7	3,8	4,0	4,1	4,3
ZF25K5E	4,5	5,8	7,3	9,1	11,3	13,8	16,8	ZF25K5E	4,2	4,4	4,7	4,9	5,2	5,4	5,7
ZF34K5E	6,2	8,0	10,1	12,7	15,7	19,3	23,4	ZF34K5E	5,4	5,8	6,1	6,5	6,9	7,3	7,6
ZF41K5E	7,6	9,7	12,3	15,2	18,8	22,9	27,7	ZF41K5E	6,6	7,0	7,5	8,0	8,4	8,9	9,3
ZF49K5E	9,1	11,7	14,8	18,6	23,0	28,1	34,2	ZF49K5E	8,0	8,6	9,1	9,6	10,2	10,7	11,2

Suction Gas Return 20°C
Preliminary data

Condensing Temperature: 40°C															
R407A	Cooling Capacity (kW)							R407A	Power Input (kW)						
	Evaporating Temperature (°C)								Evaporating Temperature (°C)						
Models	-35	-30	-25	-20	-15	-10	-5	Models	-35	-30	-25	-20	-15	-10	-5
Models with Enhanced Vapor Injection															
ZF13KVE EVI	3.1	4.0	4.9	6.0	7.3	8.7	10.4	ZF13KVE EVI	2.3	2.3	2.4	2.5	2.6	2.7	2.7
ZF18KVE EVI	4.9	6.0	7.3	8.8	10.8	13.3	16.5	ZF18KVE EVI	3.4	3.5	3.6	3.7	3.9	4.1	4.4
ZF25K5E EVI	6.1	7.7	9.4	11.4	13.5	15.8	18.2	ZF25K5E EVI	4.3	4.4	4.6	4.8	5.0	5.3	5.5
ZF34K5E EVI	8.0	9.9	12.1	14.6	17.5	20.7	24.2	ZF34K5E EVI	5.3	5.5	5.7	5.9	6.1	6.3	6.4
ZF41K5E EVI	10.1	12.6	15.5	18.7	22.1	25.8	29.7	ZF41K5E EVI	6.7	6.9	7.2	7.4	7.6	7.8	8.0
ZF49K5E EVI	12.1	15.1	18.5	22.3	26.8			ZF49K5E EVI	8.0	8.3	8.5	8.8	9.1		
Models with Liquid Injection															
ZF06K4E	1.2	1.6	2.0	2.5	3.0	3.7	4.5	ZF06K4E	1.4	1.5	1.5	1.6	1.7	1.8	1.9
ZF08K4E	1.5	1.9	2.3	2.9	3.6	4.4	5.3	ZF08K4E	1.7	1.7	1.8	1.9	2.0	2.2	2.3
ZF09K4E	1.9	2.3	2.9	3.5	4.3	5.2	6.2	ZF09K4E	1.7	1.9	2.1	2.3	2.6	3.0	3.4
ZF11K4E	2.1	2.6	3.3	4.1	5.0	6.1	7.4	ZF11K4E	1.8	1.9	2.0	2.1	2.2	2.4	2.5
ZF13K4E	2.2	2.8	3.5	4.4	5.5	6.5	7.7	ZF13K4E	2.1	2.2	2.3	2.3	2.4	2.5	2.5
ZF15K4E	2.7	3.4	4.3	5.5	6.7	8.1	9.7	ZF15K4E	2.5	2.7	2.8	2.9	3.0	3.1	3.0
ZF18K4E	3.3	4.1	5.2	6.6	8.1	9.7	11.5	ZF18K4E	3.0	3.2	3.3	3.5	3.6	3.7	3.5
ZF25K5E	4.3	5.5	6.9	8.6	10.7	13.2	16.0	ZF25K5E	4.0	4.2	4.5	4.7	4.9	5.2	5.4
ZF34K5E	5.9	7.6	9.6	12.1	15.0	18.3	22.3	ZF34K5E	5.1	5.5	5.9	6.2	6.6	6.9	7.3
ZF41K5E	7.3	9.3	11.7	14.5	17.9	21.8	26.4	ZF41K5E	6.2	6.7	7.1	7.6	8.0	8.5	8.9
ZF49K5E	8.6	11.2	14.1	17.7	21.9	26.8	32.5	ZF49K5E	7.6	8.2	8.7	9.2	9.7	10.2	10.7

Suction Gas Return 20°C
Preliminary data

Capacity Data

Condensing Temperature: 40°C															
R404A	Cooling Capacity (kW)							R404A	Power Input (kW)						
	Evaporating Temperature (°C)								Evaporating Temperature (°C)						
Models	-35	-30	-25	-20	-15	-10	-5	Models	-35	-30	-25	-20	-15	-10	-5
Models with Enhanced Vapor Injection															
ZF13KVE EVI	4.0	4.9	6.0	7.2	8.5	10.0	11.7	ZF13KVE EVI	2.9	3.0	3.1	3.2	3.3	3.4	3.5
ZF18KVE EVI	6.1	7.3	8.7	10.4	12.3	14.4	16.9	ZF18KVE EVI	4.0	4.2	4.4	4.6	4.8	4.9	5.1
ZF25K5E EVI	7.7	9.3	11.2	13.2	15.3	17.5	19.7	ZF25K5E EVI	4.8	5.1	5.4	5.7	6.0	6.3	6.6
ZF34K5E EVI	10.4	12.5	14.9	17.7	20.8	24.4	28.4	ZF34K5E EVI	6.4	6.8	7.2	7.6	7.9	8.3	8.7
ZF41K5E EVI	12.5	15.1	18.1	21.5	25.5	30.0	35.2	ZF41K5E EVI	7.9	8.3	8.8	9.2	9.7	10.1	10.6
ZF49K5E EVI	14.1	17.1	20.5	24.5	28.9			ZF49K5E EVI	9.1	9.7	10.3	10.8	11.3		
Models with Liquid Injection															
ZF06K4E	1.4	1.8	2.2	2.6	3.1	3.8	4.5	ZF06K4E	1.4	1.4	1.5	1.5	1.6	1.7	1.8
ZF08K4E	1.8	2.2	2.8	3.4	4.1	4.8	5.7	ZF08K4E	1.6	1.7	1.8	1.9	2.0	2.1	2.2
ZF09K4E	1.9	2.4	3.0	3.6	4.4	5.2	6.3	ZF09K4E	1.8	1.8	1.9	1.9	2.0	2.1	2.2
ZF11K4E	2.5	3.0	3.7	4.5	5.4	6.5	7.8	ZF11K4E	2.2	2.2	2.3	2.4	2.5	2.6	2.7
ZF13K4E	2.8	3.5	4.3	5.3	6.4	7.7	9.1	ZF13K4E	2.3	2.4	2.5	2.6	2.7	2.8	3.0
ZF15K4E	3.4	4.3	5.3	6.4	7.8	9.4	11.2	ZF15K4E	3.0	3.2	3.3	3.5	3.7	3.8	4.1
ZF18K4E	4.2	5.2	6.4	7.8	9.4	11.3	13.5	ZF18K4E	3.4	3.6	3.7	3.8	4.0	4.2	4.4
ZF25K5E	5.1	6.4	7.9	9.6	11.7	14.1	16.8	ZF25K5E	3.8	4.1	4.4	4.6	4.9	5.2	5.5
ZF34K5E	6.8	8.5	10.5	12.8	15.5	18.6	22.2	ZF34K5E	5.1	5.4	5.8	6.1	6.5	6.8	7.2
ZF41K5E	8.4	10.5	13.0	15.8	19.2	23.1	27.7	ZF41K5E	6.4	6.8	7.3	7.7	8.2	8.7	9.1
ZF49K5E	10.1	12.7	15.6	19.1	23.1	27.8	33.2	ZF49K5E	7.7	8.1	8.5	9.0	9.6	10.2	10.9

Suction Gas Return 20°C
Preliminary data

R22	Cooling Capacity (kW)							R22	Power Input (kW)						
	Evaporating Temperature (°C)								Evaporating Temperature (°C)						
Models	-35	-30	-25	-20	-15	-10	-5	Models	-35	-30	-25	-20	-15	-10	-5
ZF08K4E	2.7	3.3	4.1	5.0	6.1	7.3	8.7	ZF08K4E	2.5	2.5	2.6	2.7	2.8	2.9	3.0
ZF09K4E	1.8	2.3	2.8	3.5	4.2	5.1	6.1	ZF09K4E	1.9	1.9	2.0	2.0	2.1	2.1	2.2
ZF11K4E	2.3	2.9	3.5	4.3	5.2	6.3	7.5	ZF11K4E	2.1	2.1	2.2	2.3	2.4	2.5	2.7
ZF13K4E	2.7	3.3	4.1	5.0	6.1	7.3	8.7	ZF13K4E	2.5	2.5	2.6	2.7	2.8	2.9	3.0
ZF15K4E	3.2	4.1	5.0	6.1	7.4	8.9	10.6	ZF15K4E	3.0	3.1	3.2	3.3	3.4	3.6	3.7
ZF18K4E	3.8	4.8	5.9	7.3	8.8	10.7	12.7	ZF18K4E	3.8	3.8	3.9	4.0	4.1	4.3	4.5

Suction Gas Return 20°C
Preliminary data



ZFD & ZBD Copeland Scroll Digital™ Range for Medium and Low Temperature Refrigeration

Copeland Scroll Digital ZBD and ZFD compressors provide step-less continuous capacity modulation in medium and low temperature refrigeration applications.

Based on the unique Copeland Compliant Scroll™ design, the Digital modulation operates on a simple mechanism. Capacity control is achieved by separating the scroll sets axially over a small period of time. It is a simple mechanical solution allowing precise temperature control and system efficiency.

Digital Scroll technology is a simple modulation solution that can easily and quickly be implemented into any existing system design as no other components are required.

Digital Scroll technology provides continuous, stepless modulation from 10% to 100% with no operating envelope restriction. As a result, system pressures and temperatures are tightly controlled. These compressors provide optimum performance for condensing units, refrigeration packs, process and agricultural units.

The Digital Scroll range consists of:

- ZBD models dedicated to medium temperature applications
- ZFD models with vapor injection for low temperature applications
- ZOD model designed for use in R744 (CO₂) - see page 56



Copeland Scroll Digital for Low and Medium Temperature Refrigeration with and without Sound Shell

CoreSense™ Diagnostics is now available as an option for the ZBD Scroll Summit series (ZBD66K5E, ZBD76K5E, ZB9D5K5E and ZB-D114K5E) as well as for ZFD41K5E Summit Digital.

These compressors are qualified for R404A, R407A, R407F for some models and R22 for ZBD only.

Digital Scroll Compressor Line-up

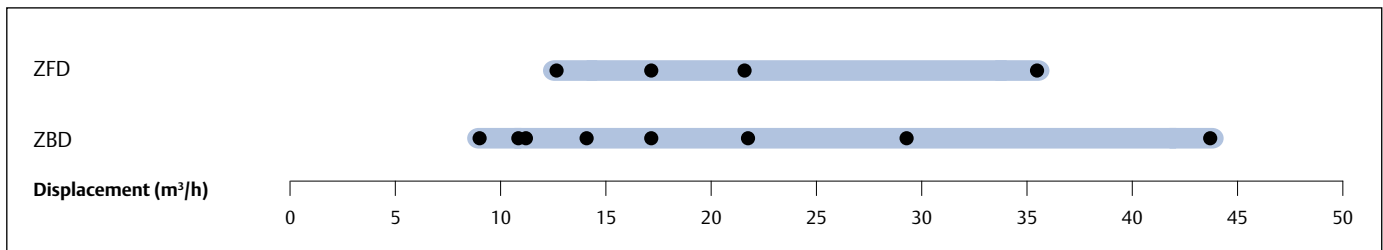

Features and Benefits

- Continuous modulation from 10% to 100% ensuring a perfect match of capacity and power to the desired load
- An economical and reliable alternative to variable speed drive
- Precise suction pressure control with associated energy savings
- Food quality is maintained by stable evaporating temperatures in the refrigerated areas
- Longer lasting refrigeration equipment due to fewer compressor cycling
- Quick and easy integration into refrigeration equipment, similar to any other scroll compressor
- Availability of optional sound shell on all models providing an additional 10dBA sound attenuation for silent operation
- Availability of Emerson's series of controllers that operate the Digital Scroll compressor

Maximum Allowable Pressure (PS)

- Digital ZBD:
Low Side PS 22.6 bar(g) / High Side PS 32 bar(g)
- Digital ZFD:
Low Side PS 19 bar(g) / High Side PS 28 bar(g)

Operating Envelope R404A

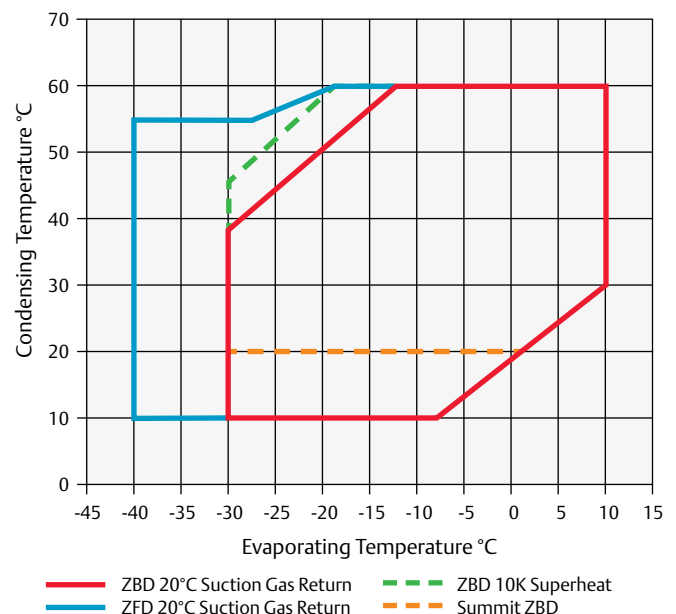

Operating Envelope R407A - For ZBD Models

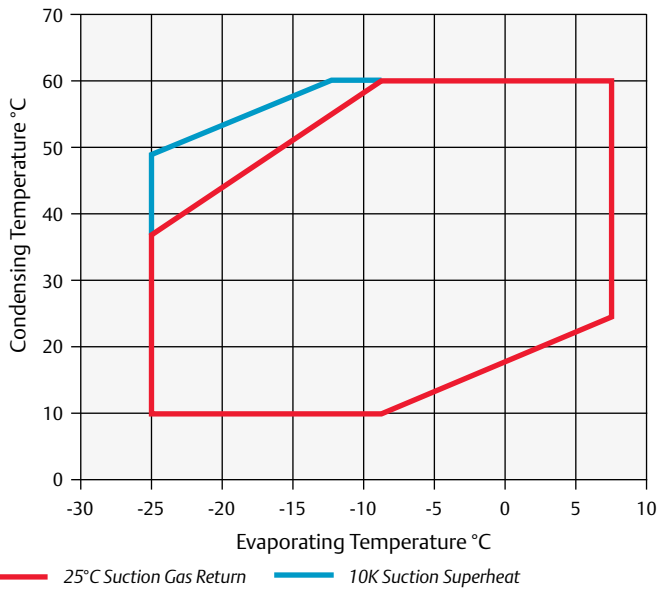

For ZFD Models

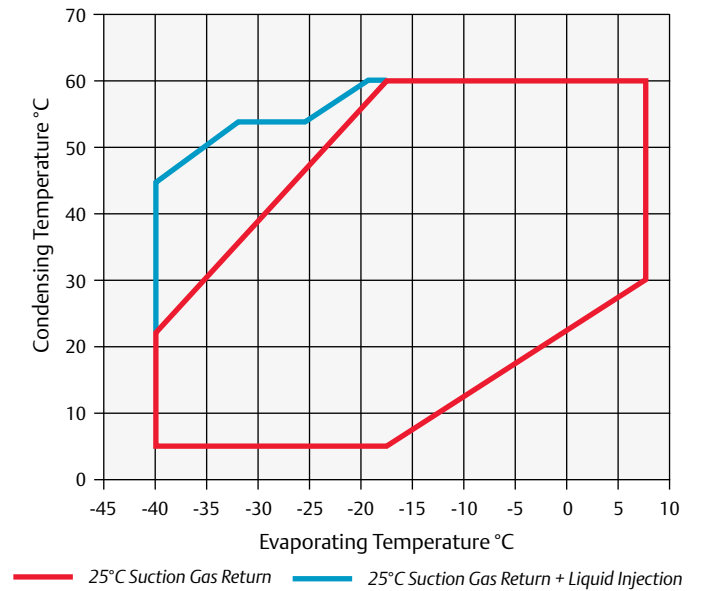

Operating Envelope R407F - For ZBD Models

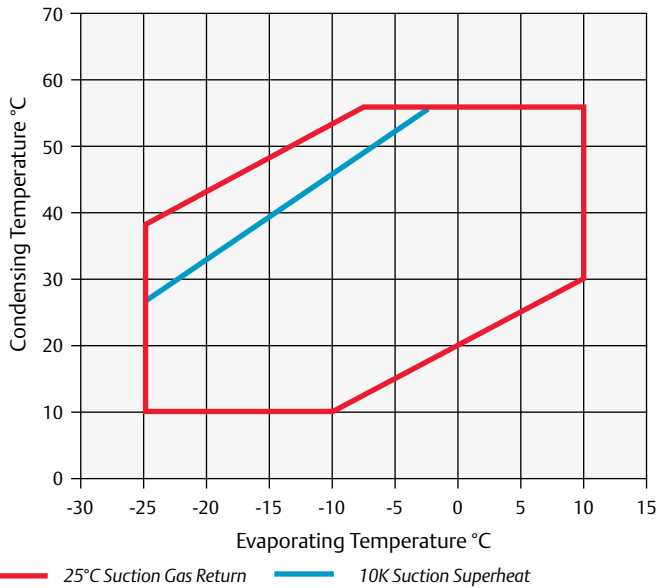

For ZFD Models

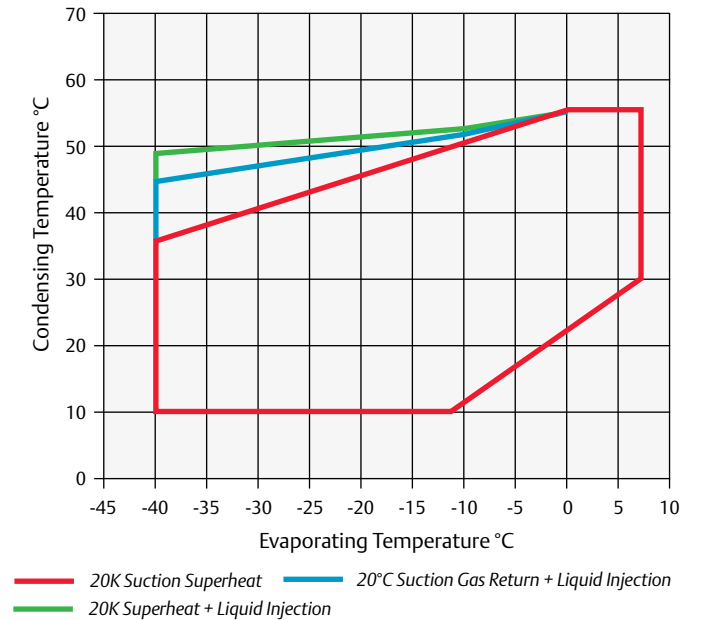

Operating Envelope R134a - For ZBD Models

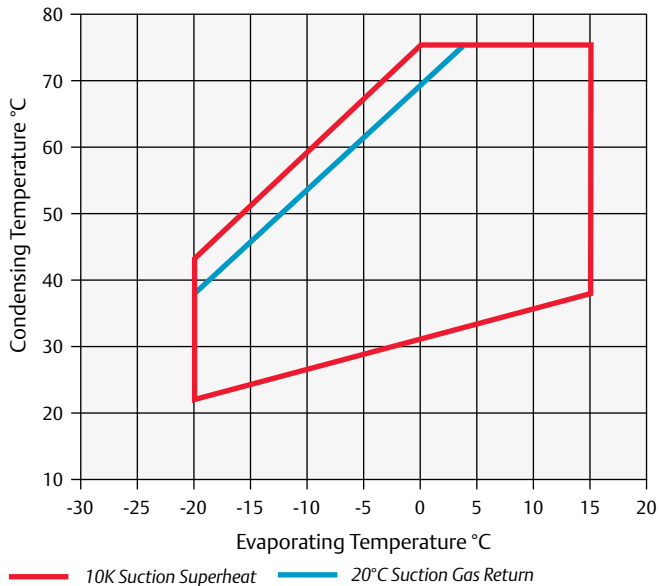

For individual model details please refer to Select Software.

Technical Overview

Models	Nominal hp	Displacement (m ³ /h)	Rotalock Suction (inch)	Rotalock Discharge (inch)	Oil Quantity (l)	Length/Width/Height (mm)	Net Weight (kg)	Motor Version/Code		Maximum Operating Current (A)		Locked Rotor Current (A)		Sound Pressure @1 m (dBA) ***
								1 Ph*	3 Ph**	1 Ph*	3 Ph**	1 Ph*	3 Ph**	
For medium temperature applications														
ZBD21KCE	3	8.3	1 1/4	1	1.2	243/243/432	30.2	PFJ	TFD	16.5	6.7	97	40	62
ZBD29KCE	4	11.4	1 1/4	1	1.4	245/243/463	32.7		TFD		7.9		48	58
ZBD30KCE	4	11.7	1 1/4	1	1.9	241/246/481	36.7		TFD		7.9			59
ZBD38KCE	5	14.4	1 1/4	1	1.9	246/250/481	38.1		TFD		11.3		64	67
ZBD45KCE	6	17.1	1 1/4	1	1.9	241/246/481	39.9		TFD		12.1			61
ZBD57KCE		21.4	1 1/4	1 1/4	1.9	246/257/481	43.1		TFD		15.9		102	65
ZBD76K5E	12	28.8	1 3/4	1 1/4	3.4	358/296/534	61.2		TFD		24		118	66
ZBD114K5E	15	43.3	1 3/4	1 1/4	3.4	393/312/552	68.9		TFD		33.3		174	71
For low temperature applications														
ZFD13KVE	4	11.7	1 1/4	1	1.9	246/250/481	38.6		TFD		9		64	
ZFD18KVE	6	17.1	1 1/4	1	1.9	300/299/481	43.1		TFD		13.8		74	
ZFD25KVE	7.5	21.4	1 1/4	1 1/4	1.9	246/250/481	43.1		TFD		16		102	
ZFD41K5E	10	35.3	1 3/4	1 1/4	3.4	363/312/534	66.2		TFD		20.4		118	73

** 3 Ph: 380-420V/ 50Hz

*** @ 1m: sound pressure level at 1m distance from the compressor, free field condition

Preliminary data

Capacity Data

Condensing Temperature: 40°C															
R134A	Cooling Capacity (kW)							R134A	Power Input (kW)						
	Evaporating Temperature (°C)								Evaporating Temperature (°C)						
Models	-35	-30	-25	-20	-15	-10	-5	Models	-35	-30	-25	-20	-15	-10	-5
ZBD21KCE				2.0*	2.7	3.3	4.0	ZBD21KCE				1.2*	1.3	1.4	1.4
ZBD38KCE				3.2*	4.4	5.5	6.8	ZBD38KCE				1.9*	2.1	2.2	2.3
ZBD45KCE				3.8*	5.1	6.4	7.9	ZBD45KCE				2.3*	2.4	2.5	2.6
ZBD57KCE				4.7*	6.4	8.1	10.1	ZBD57KCE				3.4*	3.4	3.4	3.5
ZBD76K5E				6.6*	8.4*	10.7*	13.4*	ZBD76K5E				4.8*	4.8*	4.8*	4.9*
ZBD114K5E				9.0*	12.1*	15.8*	20.0*	ZBD114K5E				6.6*	6.6*	6.7*	6.7*
ZBD28KCB				4.2	5.4	6.6	8.0	ZBD28KCB				2.2	2.3	2.4	2.4

Suction Gas Return 20°C

Preliminary data

* 10K Border

Condensing Temperature: 40°C															
R407A	Cooling Capacity (kW)							R407A	Power Input (kW)						
	Evaporating Temperature (°C)								Evaporating Temperature (°C)						
Models	-35	-30	-25	-20	-15	-10	-5	Models	-35	-30	-25	-20	-15	-10	-5
Medium Temperature															
ZBD21KCE				3.4*	4.3	5.2	6.3	ZBD21KCE				1.8*	1.9	1.9	2.0
ZBD29KCE				4.2*	5.5	6.8	8.4	ZBD29KCE				2.6*	2.6	2.6	2.6
ZBD30KCE				4.4*	5.8	7.3	9.0	ZBD30KCE				2.8*	2.8	2.8	2.8
ZBD38KCE				5.5*	7.3	9.1	11.2	ZBD38KCE				3.4*	3.4	3.4	3.5
ZBD45KCE				6.0*	8.1	10.1	12.5	ZBD45KCE				3.8*	3.8	3.8	3.9
ZBD57KCE			6.5*	8.7	11.1	13.8	17.0	ZBD57KCE			5.2*	5.2	5.2	5.3	5.3
ZBD76K5E			8.2*	11.3	14.5	18.4	22.8	ZBD76K5E			7.5*	7.1	7.1	7.3	7.5
ZBD114K5E			10.8*	15.6	20.5	26.3	32.8	ZBD114K5E			10.3*	10.2	10.2	10.3	10.5
Low Temperature															
ZFD13KVE EVI	3.2	4.1	5.2	6.4	7.7	9.2	10.9	ZFD13KVE EVI	2.7	2.8	2.8	2.9	2.9	3.0	3.1
ZFD18KVE EVI	4.9	6.0	7.3	8.8	10.8	13.3	16.5	ZFD18KVE EVI	3.4	3.5	3.6	3.7	3.8	4.1	4.4
ZFD25KVE EVI	6.2*	7.7*	9.4	11.4	13.5	15.8	18.2	ZFD25KVE EVI	5.1*	5.2*	4.6	4.8	5.0	5.3	5.5
ZFD41K5E	7.3	9.3	11.8	14.6				ZFD41K5E	6.2	6.7	7.2	7.5			
ZFD41K5E EVI	25.9	32.9	41.3	51.1				ZFD41K5E EVI	6.4	6.6	6.8	7.1			

Suction Gas Return 20°C

Preliminary data

* 10K Border

Capacity Data

Condensing Temperature: 40°C															
R407F	Cooling Capacity (kW)							R407F	Power Input (kW)						
	Evaporating Temperature (°C)								Evaporating Temperature (°C)						
Models	-35	-30	-25	-20	-15	-10	-5	Models	-35	-30	-25	-20	-15	-10	-5
Medium Temperature															
ZBD21KCE						5.1	6.3	ZBD21KCE						2.0	2.0
ZBD29KCE					5.8*	7.3	8.9	ZBD29KCE					2.9*	2.9	2.9
ZBD30KCE				4.7*	5.8*	7.3	8.8	ZBD30KCE				2.5*	2.7*	2.8	2.9
ZBD38KCE				5.7*	7.1*	8.9	10.8	ZBD38KCE				3.0*	3.3*	3.5	3.6
ZBD45KCE				6.4*	8.4*	10.8	13.2	ZBD45KCE				3.7*	3.9*	4.1	4.3
ZBD57KCE				8.5*	10.8*	13.8	17.0	ZBD57KCE				5.2*	5.2*	5.3	5.3
ZBD76K5E				11.8*	15.7	19.8	24.6	ZBD76K5E				7.4*	7.4	7.5	7.8
ZBD114K5E				15.0*	20.5	26.3	32.7	ZBD114K5E				10.1*	10.2	10.3	10.5
Low Temperature															
ZFD13KVE EVI	3.3	4.3	5.4	6.7	8.1	9.7	11.4	ZFD13KVE EVI	2.8	2.9	3.0	3.0	3.1	3.2	3.2
ZFD18KVE EVI	4.9	6.2	7.6	9.3	11.3	13.5	16.0	ZFD18KVE EVI	3.8	4.0	4.1	4.3	4.4	4.6	4.7
ZFD41K5E	7.3	9.3	11.8	14.6				ZFD41K5E	6.2	6.7	7.2	7.5			
ZFD25KVE EVI	6.4	8.0	9.9	11.9	14.2	16.6	19.1	ZFD25KVE EVI	4.5	4.7	4.9	5.1	5.3	5.5	5.8
ZFD41K5E EVI	23.5	29.8	37.2	45.9				ZFD41K5E EVI	6.4	6.6	6.8	7.1			

Suction Gas Return 20°C

Preliminary data

* 10K Border

Condensing Temperature: 40°C															
R404A	Cooling Capacity (kW)							R404A	Power Input (kW)						
	Evaporating Temperature (°C)								Evaporating Temperature (°C)						
Models	-35	-30	-25	-20	-15	-10	-5	Models	-35	-30	-25	-20	-15	-10	-5
Medium Temperature															
ZBD21KCE			3.0	3.7	4.5	5.5	6.6	ZBD21KCE			1.9	2.0	2.0	2.1	2.1
ZBD29KCE			4.1	5.1	6.2	7.4	8.9	ZBD29KCE			2.5	2.6	2.7	2.8	2.8
ZBD38KCE			5.2	6.3	7.7	9.3	11.1	ZBD38KCE			3.1	3.2	3.4	3.5	3.7
ZBD45KCE			6.1	7.6	9.2	11.2	13.4	ZBD45KCE			3.7	3.8	4.0	4.2	4.4
ZBD57KCE			7.9	9.7	11.9	14.3	17.1	ZBD57KCE			4.7	4.9	5.2	5.4	5.5
ZBD76K5E			10.6	13.3	16.4	20.0	23.9	ZBD76K5E			7.5	7.6	7.6	7.7	7.8
ZBD114K5E			14.2	18.6	23.4	28.7	34.7	ZBD114K5E			11.3	11.3	11.3	11.4	11.4
Low Temperature															
ZFD13KVE EVI	4.0	4.9	6.0	7.2	8.5	10.0	11.7	ZFD13KVE EVI	2.9	3.0	3.1	3.2	3.3	3.4	3.5
ZFD18KVE EVI	6.1	7.3	8.7	10.4	12.3	14.4	16.9	ZFD18KVE EVI	4.0	4.2	4.4	4.6	4.8	4.9	5.1
ZFD25KVE EVI	7.7	9.3	11.2	13.2	15.3	17.5	19.7	ZFD25KVE EVI	4.8	5.1	5.4	5.7	6.0	6.3	6.6
ZFD41K5E	8.6	10.6	13.0	15.7				ZFD41K5E	6.3	6.7	7.1	7.5			
ZFD41K5E EVI	12.5	15.0	18.1	21.5				ZFD41K5E EVI	7.8	8.3	8.8	9.2			

Suction Gas Return 20°C

Preliminary data

Capacity Data

Condensing Temperature: 40°C															
R407C	Cooling Capacity (kW)							R407C	Power Input (kW)						
	Evaporating Temperature (°C)								Evaporating Temperature (°C)						
Models	-35	-30	-25	-20	-15	-10	-5	Models	-35	-30	-25	-20	-15	-10	-5
Medium Temperature															
ZBD29KCE			2.9*	3.9*	5.0*	6.4	7.9	ZBD29KCE			2.5*	2.5*	2.5*	2.5	2.5
ZBD45KCE				5.8*	7.7	9.6	11.9	ZBD45KCE				3.6*	3.6	3.7	3.7
ZBD57KCE			5.0*	6.9	8.9	11.3	14.1	ZBD57KCE			4.5*	4.6	4.8	4.8	4.9
ZBD76K5E				10.7*	13.9	17.3	21.2	ZBD76K5E				6.8*	6.8	6.9	6.9
ZBD114K5E				14.2*	19.2	24.3	30.0	ZBD114K5E				9.6*	9.7	9.8	9.8

Suction Gas Return 20°C

Preliminary data

* 10K Border

Condensing Temperature: 40°C															
R22	Cooling Capacity (kW)							R22	Power Input (kW)						
	Evaporating Temperature (°C)								Evaporating Temperature (°C)						
Models	-35	-30	-25	-20	-15	-10	-5	Models	-35	-30	-25	-20	-15	-10	-5
ZBD30KCE			3.4*	4.4*	5.5*	6.9	8.4	ZBD30KCE			2.4*	2.5*	2.5*	2.6	2.7
ZBD45KCE			5.2*	6.6*	8.2*	10.1	12.3	ZBD45KCE			3.5*	3.6*	3.6*	3.7	3.8

Suction Gas Return 20°C

Preliminary data

* 10K Border

ZO & ZOD Copeland Scroll™ Compressor Range for CO₂-Subcritical Refrigeration

ZO Copeland Scroll Compressors have been designed for use in R744 (CO₂) low temperature refrigeration systems. These compressors are suitable for usage in CO₂-subcritical cascade and booster systems.

Increasing environmental concerns about potential direct emissions from HFC-based refrigeration systems into the atmosphere have led to the revival of R744 in parts of the European refrigeration market. Regionally, this trend is reinforced by legislation and taxation schemes which favor the usage of refrigerant R744.

In comparison with HFC refrigerants, the specific properties of R744 require changes in the design of the refrigeration system. The ZO range of Copeland Scroll compressors has been particularly designed to exploit the characteristics of the R744 refrigeration system. Efficiency, reliability and liquid handling advantages of the Copeland Scroll technology equally apply.

The optimized design of ZO compressors effectively address the challenges of R744 systems i.e., high pressure levels, higher mass flow for a given displacement while securing proper lubrication.

The range consists of 6 models including 1 digital model for 10 to 100% continuous cooling capacity modulation



ZO Compressor for Low Temperature Refrigeration

ZO and ZOD Compressor Line-up

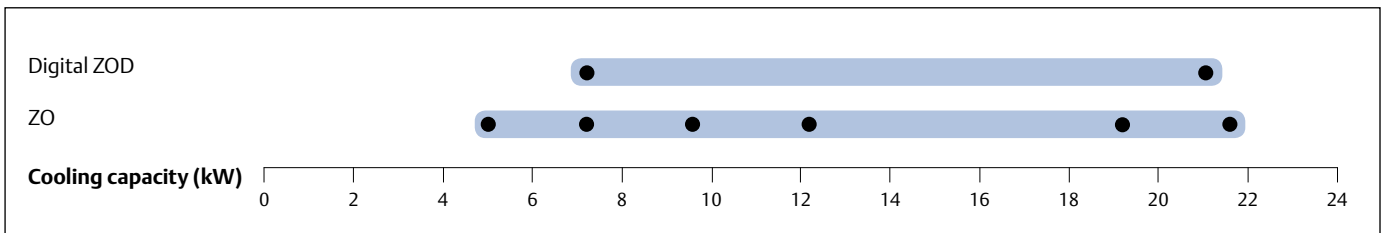

Conditions EN12900 R744: Evaporating -35°C, Condensing -5°C, Suction Superheat 10K, Subcooling 0K

Features and Benefits

- Optimized for high efficiency in CO₂-subcritical cascade and booster systems
- High condensing temperature limit allowing for optimized overall system design
- Compact design minimizing required machine room space
- Half the weight of equivalent semi-hermetic compressors
- Optional Sound Shell allowing 10 dBA sound attenuation
- High bearing reliability and lubrication of all critical parts under all conditions including liquid slugging
- Availability of a digital model offering simple, stepless 10 to 100% capacity modulation

Maximum Allowable Pressure (PS)

- ZO:
Low Side PS 30 bar(g) / High Side PS 45 bar(g)
- Digital ZOD:
Low Side PS 30 bar(g) / High Side PS 45 bar(g)

Operating Envelope R744

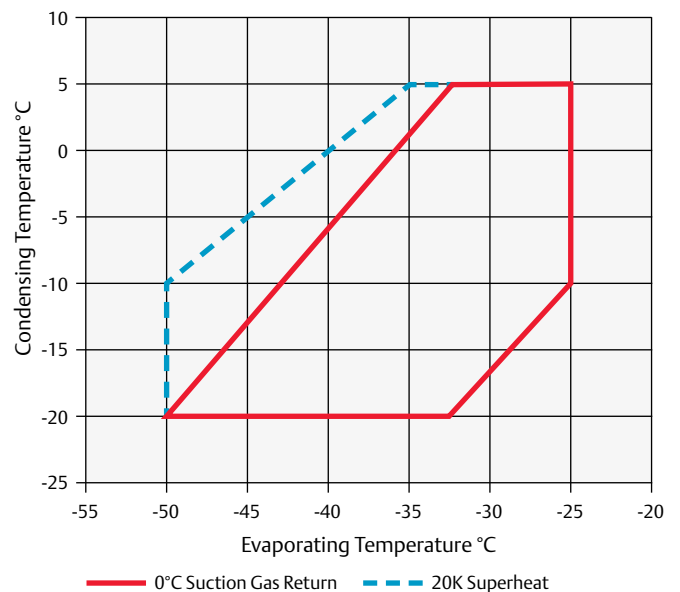

For individual model details please refer to Select Software.

Technical Overview

Models	Nominal hp	Displacement (m ³ /h)	Stub Suction (inch)	Stub Discharge (inch)	Oil Quantity (l)	Length/Width/Height (mm)	Net Weight (kg)	Motor Version/Code	Maximum Operating Current (A)	Locked Rotor Current (A)	Sound Pressure @1 m (dBA)***
								3 Ph**	3 Ph**	3 Ph**	
ZO21K5E	1.5	2.6	1 ¼	1	1.0	228/228/388	22.2	TFD	3.6	27	60
ZO34K3E	2	4.1	1 ¼	1	1.4	242/242/381	30	TFD	5.5	26	54
ZO45K3E	2.5	5.4	1 ¼	1	1.4	242/242/403	31	TFD	6.2	35	56
ZO58K3E	3.5	6.9	1 ¼	1	1.4	242/242/417	32.5	TFD	8	48	56
ZO88KCE	5	10.1	1 ¼	1	1.9	245/249/440	40.3	TFD	11.8	64	60
ZO104KCE	6	11.7	1 ¼	1	1.9	242/242/461	40	TFD	15	74	61
Digital Models											
ZOD34K3E	2	4.07	1 ¼	1	1.4	242/242/377	30	TFD	5.5	26	62
ZOD104KCE	6	11.7	1 ¼	1	1.9	241/246/484	41	TFD	15	75	67

Preliminary data

Capacity Data

Condensing Temperature: -10°C									
R744	Cooling Capacity (kW)				R744	Power Input (kW)			
	Evaporating Temperature (°C)					Evaporating Temperature (°C)			
Models	-45	-40	-35	-30	Models	-45	-40	-35	-30
ZO21K5E	3.2	4.1	5.1	6.2	ZO21K5E	1.2	1.2	1.2	1.1
ZO34K3E	4.8	6.2	7.8	9.7	ZO34K3E	1.8	1.8	1.8	1.7
ZO45K3E	7.0	8.8	10.9	13.3	ZO45K3E	2.3	2.3	2.3	2.2
ZO58K3E	8.9	11.2	13.9	17.0	ZO58K3E	3.0	3.0	2.9	2.8
ZO88KCE	13.3	17.0	21.0	25.4	ZO88KCE	4.5	4.5	4.4	4.2
ZO104KCE	15.9	19.7	24.1	29.2	ZO104KCE	4.9	5.0	5.1	5.2
Digital Models									
ZOD34K3E	5.1	6.4	7.9	9.7	ZOD34K3E	1.8	1.8	1.8	1.7
ZOD104KCE	15.6	19.1	23.2	27.9	ZOD104KCE	5.0	5.0	5.1	5.3

10 K Superheat
Preliminary data

Sound Shell for Copeland Scroll™ Compressors

Quiet Operation in Sound Critical Environment

Environmental noise has become a serious problem that can lead to potential contentious situations. It is particularly true for refrigeration applications where kitchen equipment or compressor packs are often source of disturbing noise in domestic areas. Emerson Climate Technologies put sound minimisation at the centre of any of its new compressor development along reliability, seasonal efficiency, size and weight reduction.

A large portion of equipment acoustic emissions come from condensers and compressors and in some critical sound sensitive applications the refrigeration installations need to be acoustically insulated. Simple solutions are now available to contain sound emissions. Emerson Climate Technologies has developed a dedicated Sound Shell for all Copeland Scroll compressors from 2–15 hp. It completely encapsulates the compressor, minimizing sound leaks while cooling performance remains uncompromised.

Groundbreaking design techniques and materials, derived from the automotive industry, were utilized to design the Sound Shell. The use of low pressure reaction injection moulded parts (top cap cover, terminal box cover and compressor base plate) allows a 10–12 dBA sound attenuation.

It is a significant improvement over conventional sound jackets available from other suppliers that reduce sound by 3–6 dBA depending on the application. Particular attention was also paid in the design stage to ensure ease of mounting in retrofit, service and new installation situations.

Sound Shell for Copeland Scroll



2 to 4 hp scroll



4 to 6 hp scroll



4 to 6 hp scroll
ZF with DTC



4 to 6 hp
Digital Scroll



Summit Series
7 to 15 hp scroll



Summit Series
Digital Scroll

Technical Overview

	Small Scroll	Summit Scroll			Summit Digital Scroll	
	All sizes	Small size	Medium size	Large size	Small size	Medium size
Technical Data						
Sound attenuation	10 - 12 dBA					
Total Weight (kg)	3.4	4.8	4.9	5.1	5.3	5.6
Mantle Thickness	25mm					
Flammability	Conforms to IEC 60335-1 §30					
Material						
Mantle	Green felt layer (cotton + binder 1.2 kg/m ²)					
	Heavy layer (PVC 4.5 kg/m ²)					
	Closure by use of Velcro fastening - High frequency welded on PVC layer					
Base Plate	PU SRIM - Low pressure reaction injection moulding technology					
Top Cap Cover	PU SRIM - Low pressure reaction injection moulding technology					
	Inside insulation green felt and aluminium film					
	High temperature insulation ring					
Terminal Box Cover	PU SRIM - Low pressure reaction injection moulding technology					

Scroll Booster Compressor

Compressors for the low stage in cascade or booster refrigeration systems are available as part of the scroll range from 2 to 15 hp. These provide optimized energy efficiency for refrigeration systems operating at low evaporating temperatures.



Scroll Booster Compressor

Scroll Booster Compressor Line-up

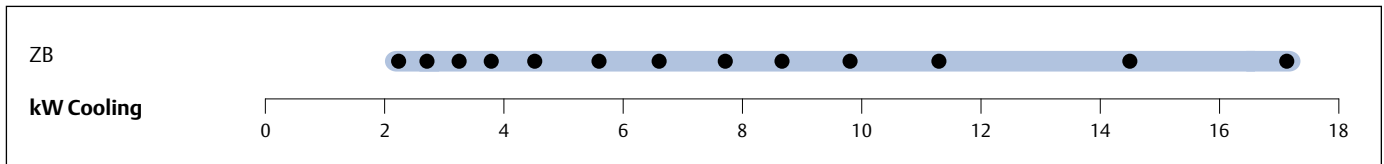

Conditions R404A: Evaporating -35°C, Condensing -10°C, Suction Gas Return 20°C, Subcooling 0K

Features and Benefits - Scroll Booster

- PTFE-coated bearings for especially low friction and good protection at start-up
- Copeland Scroll™ axial and radial compliance for superior reliability and efficiency
- Light weight and compactness
- Availability of optional sound shell on all model providing an additional 10dBA sound attenuation for silent operation

Maximum Allowable Pressure (PS)

- Low Side PS 22.6 bar(g) / High Side PS 32 bar(g)

Operating Envelope R404A - Scroll Booster

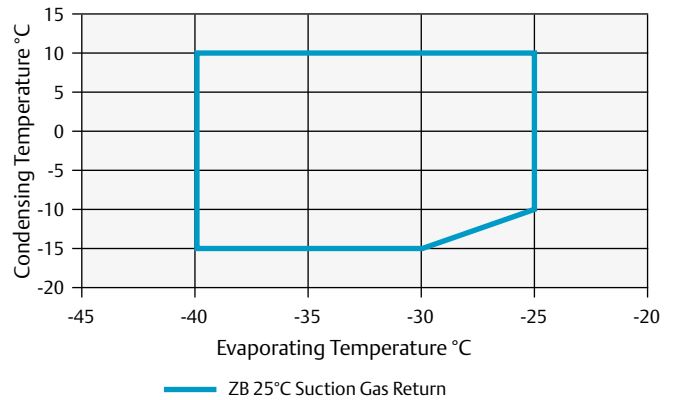

For individual model details please refer to Select Software.

Capacity Data - Scroll Booster

Condensing Temperature -10°C															
R404A		Cooling Capacity (kW)						R404A		Power Input (kW)					
		Evaporating Temperature (°C)								Evaporating Temperature (°C)					
Model	-45	-40	-35	-30	-25	-20	-15	Model	-45	-40	-35	-30	-25	-20	-15
ZB15KCE-B		1.9	2.2	2.7	3.3			ZB15KCE-B		0.4	0.5	0.4	0.4		
ZB19KCE-B		2.1	2.6	3.3	4.2			ZB19KCE-B		0.6	0.6	0.6	0.5		
ZB21KCE-B		2.6	3.1	3.8	4.7			ZB21KCE-B		0.7	0.7	0.7	0.7		
ZB26KCE-B		2.9	3.7	4.6	5.8			ZB26KCE-B		0.8	0.8	0.8	0.8		
ZB30KCE-B		3.5	4.4	5.5	6.8			ZB30KCE-B		0.9	0.9	0.9	0.9		
ZB38KCE-B		4.3	5.5	6.9	8.6			ZB38KCE-B		1.1	1.1	1.1	1.0		
ZB45KCE-B		5.2	6.6	8.3	10.5			ZB45KCE-B		1.2	1.2	1.2	1.2		
ZB50KCE-B		6.2	7.8	9.8	12.1			ZB50KCE-B		1.4	1.3	1.4	1.4		
ZB58KCE-B		6.8	8.7	10.8	13.4			ZB58KCE-B		1.5	1.5	1.5	1.6		
ZB66KCE-B		7.7	9.8	12.3	15.3			ZB66KCE-B		1.8	1.8	1.9	1.9		
ZB76KCE-B		8.9	11.3	14.3	17.7			ZB76KCE-B		2.1	2.1	2.2	2.2		
ZB95KCE-B		11.3	14.4	18.0	22.2			ZB95KCE-B		2.5	2.5	2.5	2.6		
ZB114KCE-B		13.7	17.2	21.4	26.5			ZB114KCE-B		2.9	3.0	3.0	3.1		

Suction Gas Return 20°C / Subcooling 0K

Semi-Hermetic Reciprocating Compressors

Emerson Climate Technologies offers different ranges of semi-hermetic reciprocating compressors with distinct levels of performance and technical characteristics depending on the application requirements.

The S-Series:

Its design is based on traditional “reed” valve plates similar to what is used in reciprocating compressors offered by other manufacturers. The performance of such compressors meets basic market requirements but cannot compete with Discus compressors in terms of efficiency. The S-Series ranges from 1.5 to 70 hp and is composed of K and L presented in this catalogue.



S-Series

The Discus Range:

It is broadly recognized as the most efficient compressor whatever the running condition. This range is mainly used in refrigeration medium and low temperature applications where system efficiency is a priority for the end-user. The key difference between Discus and other reciprocating compressors lies in its valve plate design. Traditional “reed” valves are replaced by ‘puck’ type valves that are integrated in the valve plate. This special design eliminates the dead volume at the end of the compression and allows for the highest compressor efficiency. To date, no other reciprocating compressor is able to match Discus in terms of performance. Available from 4 to 60 hp, they are referred to as 2D, 3D and 8D in this catalogue.



Discus 2 Cylinder

The Stream Series:

Emerson Climate Technologies has introduced Stream, a brand new line of semi-hermetic 4 and 6 cylinder compressors. The series provides best in class performance for today’s HFC-based and uprising natural and low GWP refrigerants, significantly reducing cost of operation and environmental impact compared to competing products.

The range is made of 4 and 6 cylinder models, available for inverter applications, and 4 and 6 cylinder digital models for continuous capacity modulation. The compressors can be fitted with a dedicated sound shell for sound sensitive applications.

The new Emerson Climate Technologies line-up of 4 cylinder compressors for CO₂-transcritical applications is the ideal solution for R744 medium temperature cascade and booster systems. It is characterised by a design pressure of 135 bar. Refrigerant flow and heat transfer have been optimized for best performance. In combination with the CO₂-subcritical scroll for the low temperature refrigeration side, Emerson Climate Technologies offers the most energy efficient package available on the market today.

With advanced protection and diagnostics features for system reliability, reduced service costs and increased equipment uptime, the Stream series is built to last in today’s modern and changing world.



Stream 4 Cylinder



Stream 6 Cylinder



Stream Digital 4 Cylinder



Stream Digital 6 Cylinder



Stream 4 Cylinder for R744



Sound Shell for Stream

Emerson CoreSense™ Diagnostics for Refrigeration

Emerson CoreSense Diagnostics is an innovative technology for Copeland Stream refrigeration compressors. It goes beyond compressor protection by assisting in system diagnosis and optimization. Providing service engineers with detailed information at the right time, system-related problems can be diagnosed faster or even before they occur. Supermarket operators benefit from increased system uptime, reduction in food loss and reduced maintenance costs.

Technical Specification

- Power supply 120/240V AC, 24V AC
- Front end: 2 x LED, green/red, yellow
- Communication protocol (Modbus®RTU)
- Bus to system controller: RS 485, 3-wire, (+, GND,-)
- Discharge temperature sensor
- Current sensor and sensor module
- Flash memory
- Alarm reset button
- IP 54

Benefits

- Reduce applied system costs
- Manage on-site compressor data
- Facilitate predictive maintenance & advanced diagnostics
- Reduce maintenance costs
- Increase system uptime / reduce food loss
- Power consumption monitoring



Emerson CoreSense Diagnostics for Refrigeration.
Ensuring Best Performance over Full Lifetime.

Functions

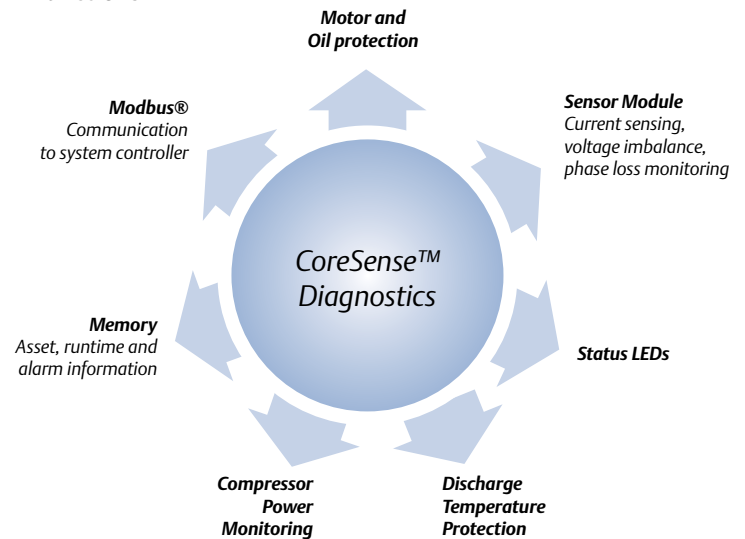

Scope of Supply

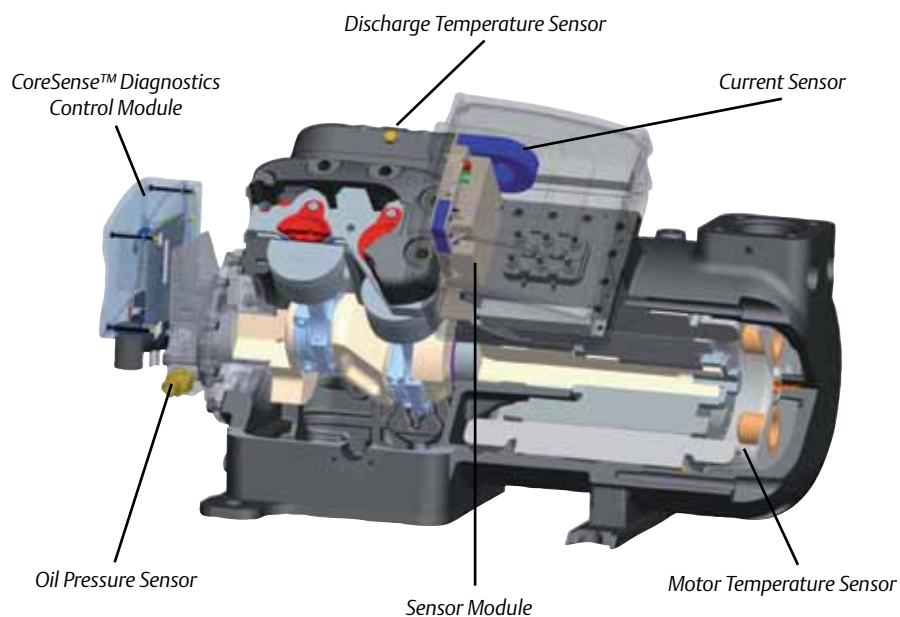

K and L Reciprocating Compressor Range

Small 2-cylinder semi-hermetic reciprocating compressors for medium and low temperature refrigeration applications and transport refrigeration.

Designed on the principle of standard reed valve type technology, these compressors feature an internal oil pump that guarantees optimum reliability in all operating conditions.

The K-series ranges from 0.5 to 2 hp and the L-series from 2 to 5 hp with a displacement of 4 to 22.5 m³/h.

These compressors are qualified for R404A, R507, R134a and R22.



K-Series Compressor

K & L Compressor Line-up

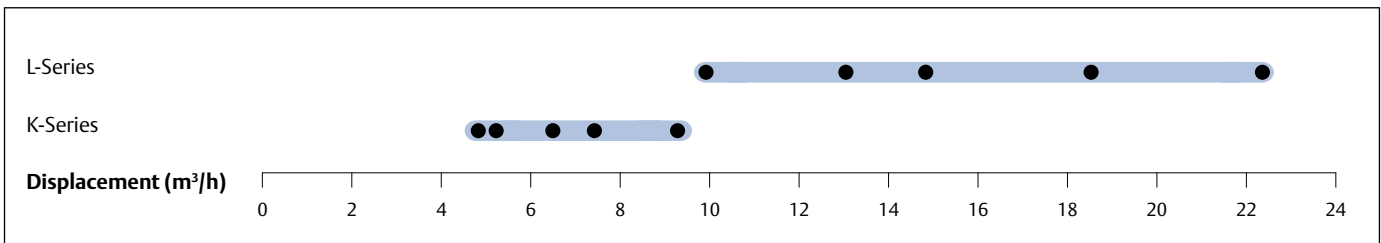

Features and Benefits

- Large operating envelope from 5°C to -45°C evaporating and up to 55°C condensing
- Two motor sizes per displacement, optimized for different applications
- Compact and light compressors
- Ideal for condensing unit or transport applications
- Integrated oil pump for maximum reliability

Maximum Allowable Pressure (PS)

- Low Side PS 22.5 bar (g)/ High Side PS 28 bar (g)

Operating Envelope R404A

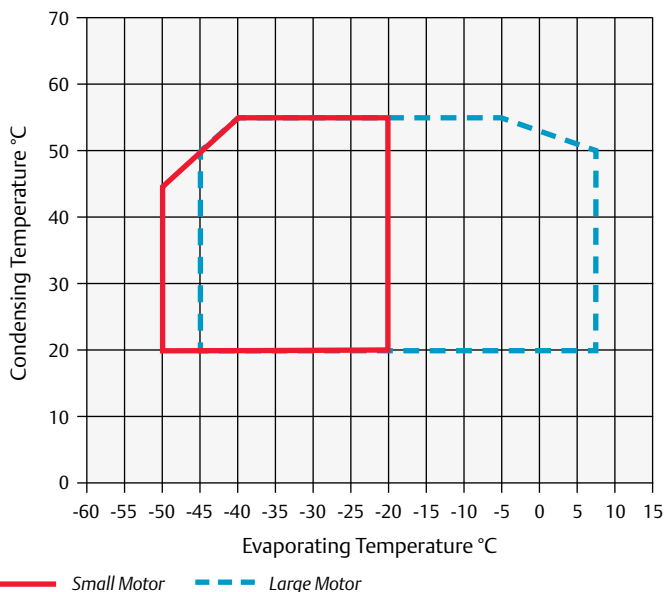

Operating Envelope R134a

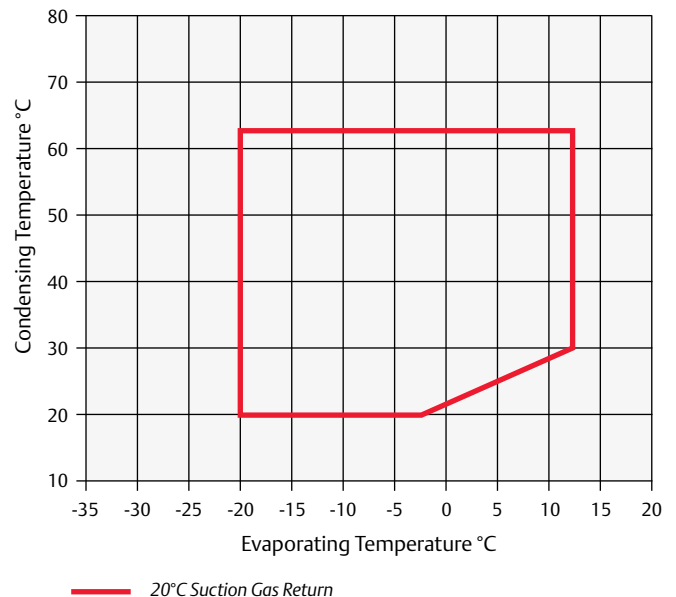

For individual model details please refer to Select Software.

Technical Overview

Models	Nominal hp	Displacement (m ³ /h)	Oil Quantity (l)	Length/Width/Height (mm)	Net Weight (kg)	Motor Version/ Code		Maximum Operating Current (A)		Locked Rotor Current (A)		Sound Pressure @ 1 m (dBA) ***
						1 Ph*	3 Ph**	1 Ph*	3 Ph**	1 Ph*	3 Ph**	
KM-5X	0.5	4.0	0.7	365/235/280	39.0	CAG	EWL	4.8	1.8	24.0	12.2	45.0
KM-7X	0.8	4.0	0.7	365/235/280	39.0	CAG	EWL	6.0	2.4	34.5	12.2	45.0
KJ-7X	0.8	5.1	0.7	365/235/280	39.0	CAG	EWL	5.8	2.3	34.5	12.2	45.0
KJ-10X	1.0	5.1	0.7	365/235/280	39.0	CAG	EWL	7.1	3.2	32.4	15.5	45.0
KSJ-10X	1.0	6.3	0.7	365/235/280	40.0	CAG	EWL	6.7	2.7	32.4	15.5	50.0
KSJ-15X	1.5	6.3	0.7	365/235/280	40.0	CAG	EWL	9.0	3.4	43.0	19.1	53.0
KL-15X	1.5	7.4	0.7	365/235/280	39.0	CAG	EWL	8.4	3.4	43.0	19.1	47.0
KL-20X	2.0	7.4	0.7	365/235/280	39.0		EWL		3.8		20.4	
KSL-20X	2.0	9.1	0.7	365/235/280	40.0		EWL		4.7		20.4	
LE-20X	2.0	9.9	2.0	470/330/385	78.0		EWL		5.7		37.6	51.0
LF-20X	2.0	12.9	2.0	470/330/385	80.0		EWL		5.5		37.6	51.0
LF-30X	3.0	12.9	2.0	470/330/385	80.0		EWL		7.2		53.0	51.0
LJ-20X	2.0	14.5	2.0	470/330/385	78.0		EWL		5.6		37.6	52.0
LJ-30X	3.0	14.5	2.0	470/330/385	83.0		EWL		8.1		53.0	52.0
LL-30X	3.0	18.2	2.0	470/330/385	85.0		EWL		7.3		50.6	52.0
LL-40X	4.0	18.2	2.0	470/330/385	87.0		EWL		9.5		58.9	63.0
LSG-40X	4.0	22.5	2.0	470/330/385	77.0		EWL		8.9		58.9	63.0

* 1 Ph: 230V/ 50Hz

** 3 Ph: 380-420V/ 50Hz

*** @ 1m: sound pressure level at 1m distance from the compressor, free field condition

Capacity Data

Condensing Temperature: 40°C															
R134a	Cooling Capacity (kW)							R134a	Power Input (kW)						
	Evaporating Temperature (°C)								Evaporating Temperature (°C)						
Models	-45	-35	-30	-20	-10	-5	+5	Models	-45	-35	-30	-20	-10	-5	+5
KM-5X				0.7°	1.2°	1.5°	2.3°	KM-5X				0.5°	0.6°	0.6°	0.7°
KJ-7X				0.9°	1.6°	2.0°	3.0°	KJ-7X				0.6°	0.7°	0.8°	0.8°
KSJ-10X				1.2°	2.0°	2.5°	3.8°	KSJ-10X				0.7°	0.8°	0.9°	1.0°
KL-15X				1.4°	2.2°	2.8°	4.3°	KL-15X				0.8°	1.0°	1.1°	1.3°
KSL-15X				1.7°	2.8°	3.5°	5.3°	KSL-15X				1.0°	1.3°	1.4°	1.6°
KSL-20X				1.7°	2.9°	3.7°	5.6°	KSL-20X				1.0°	1.2°	1.4°	1.6°
LE-20X				1.5°	2.8°	3.6°	5.6°	LE-20X				1.0°	1.3°	1.4°	1.5°
LF-20X				2.2°	3.8°	4.9°	7.5°	LF-20X				1.2°	1.6°	1.7°	1.9°
LJ-20X				2.6°	4.3°	5.4°	8.3°	LJ-20X				1.6°	1.9°	2.1°	2.4°
LL-30X				3.2°	5.5°	7.0°	10.9°	LL-30X				1.9°	2.4°	2.6°	3.0°
LSG-40X				4.3°	7.2°	9.0°	13.7°	LSG-40X				2.3°	2.9°	3.2°	3.7°

Suction Gas Return 20°C / Subcooling 0K

° High Discharge Temp - Additional Cooling Required

Condensing Temperature: 40°C															
R404A	Cooling Capacity (kW)							R404A	Power Input (kW)						
	Evaporating Temperature (°C)								Evaporating Temperature (°C)						
Models	-45	-35	-30	-20	-10	-5	+5	Models	-45	-35	-30	-20	-10	-5	+5
KM-5X	0.2°	0.6°	0.8°	1.3°				KM-5X	0.3°	0.5°	0.6°	0.7°			
KM-7X	0.2°	0.5°	0.8°	1.3°	2.0°	2.5°	3.6°	KM-7X	0.3°	0.5°	0.6°	0.8°	0.9°	1.0°	1.0°
KJ-7X	0.4°	0.8°	1.1°	1.8°				KJ-7X	0.5°	0.7°	0.8°	1.0°			
KJ-10X	0.3°	0.8°	1.0°	1.8°	2.8°	3.4°	4.9°	KJ-10X	0.4°	0.7°	0.8°	1.0°	1.2°	1.3°	1.4°
KSJ-10X	0.5°	1.0°	1.4°	2.3°				KSJ-10X	0.7°	0.9°	1.1°	1.3°			
KSJ-15X	0.5°	1.0°	1.4°	2.3°	3.5°	4.2°	6.1°	KSJ-15X	0.6°	0.9°	1.0°	1.3°	1.6°	1.7°	1.8°
KL-15X	0.6°	1.2°	1.6°	2.6°				KL-15X	0.8°	1.0°	1.2°	1.5°			
KL-20X	0.5°	1.1°	1.5°	2.6°	4.1°	5.0°		KL-20X	0.6°	0.9°	1.1°	1.4°	1.7°	1.8°	
KSL-20X	0.8°	1.5°	2.0°	3.3°	5.1°	6.1°		KSL-20X	0.8°	1.2°	1.4°	1.9°	2.3°	2.5°	
LE-20X		1.1°	1.7°	3.2°	5.1°	6.4°	9.4°	LE-20X		1.0°	1.2°	1.6°	2.0°	2.2°	2.5°
LF-20X		1.8°	2.3°	4.0°				LF-20X		1.4°	1.7°	2.2°			
LF-30X	0.7°	1.9°	2.6°	4.6°	7.2°	8.8°	12.8°	LF-30X	1.0°	1.6°	1.9°	2.4°	2.9°	3.1°	3.4°
LJ-20X		1.9°	2.8°	5.0°				LJ-20X		1.6°	1.9°	2.6°			
LJ-30X	0.8°	2.1°	2.9°	5.1°	8.0°	9.8°	14.2°	LJ-30X	1.1°	1.8°	2.1°	2.8°	3.3°	3.6°	3.9°
LL-30X	0.9°	2.6°	3.7°	6.5°				LL-30X	1.1°	2.0°	2.4°	3.3°			
LL-40X	1.1°	2.7°	3.7°	6.4°	10.2°	12.6°	18.4°	LL-40X	1.4°	2.2°	2.6°	3.3°	4.0°	4.3°	4.9°
LSG-40X	1.4°	3.5°	4.8°	8.2°				LSG-40X	1.6°	2.6°	3.1°	4.1°			

Suction Gas Return 20°C / Subcooling 0K

° High Discharge Temp - Additional Cooling Required

Capacity Data

Condensing Temperature: 40°C															
R22	Cooling Capacity (kW)							R22	Power Input (kW)						
	Evaporating Temperature (°C)								Evaporating Temperature (°C)						
Models	-45	-35	-30	-20	-10	-5	+5	Models	-45	-35	-30	-20	-10	-5	+5
KM-50/-5X		0.4°	0.6°	1.2°	1.9°	2.3°		KM-50/-5X		0.4°	0.5°	0.7°	0.8°	0.8°	
KM-75/-7X		0.4°	0.6°	1.2°	1.9°	2.4°	3.5°	KM-75/-7X		0.5°	0.5°	0.7°	0.8°	0.8°	0.9°
KJ-10X		0.7°	0.9°	1.6°	2.6°	3.2°	4.7°	KJ-10X		0.6°	0.7°	0.9°	1.0°	1.1°	1.2°
KJ-75/-7X	0.28°	0.7°	0.9°	1.6°	2.5°	3.1°		KJ-75	0.4°	0.6°	0.7°	0.9°	1.0°	1.1°	
KJ-100		0.7°	0.9°	1.6°	2.6°	3.2°	4.7°	KJ-100		0.6°	0.7°	0.9°	1.0°	1.1°	1.2°
KSJ-10X	0.44°	0.9°	1.2°	2.0°	3.2°	3.9°		KSJ-10X	0.5°	0.8°	0.9°	1.1°	1.3°	1.4°	
KSJ-15X		0.9°	1.2°	2.1°	3.3°	4.0°	5.7°	KSJ-15X		0.8°	0.9°	1.1°	1.3°	1.4°	1.5°
KSJ-100	0.44°	0.9°	1.2°	2.0°	3.2°	3.9°		KSJ-100	0.5°	0.8°	0.7°	1.1°	1.3°	1.4°	
KSJ-150		0.9°	1.2°	2.1°	3.3°	4.0°	5.7°	KSJ-150		0.8°	0.9°	1.1°	1.3°	1.4°	1.5°
KL-150/-15X	0.50°	1.0°	1.4°	2.4°	3.7°	4.6°		KL-150/-15X	0.6°	0.9°	1.1°	1.3°	1.5°	1.7°	
KSL-200/-20X		1.3°	1.8°	3.0°	4.7°	5.7°		KSL-200/-20X		1.1°	1.3°	1.6°	1.9°	2.1°	
LE-201/-20X		1.1°	1.6°	2.9°	4.8°	6.1°	9.1°	LE-201/-20X		1.1°	1.3°	1.7°	2.0°	2.1°	2.3°
LF-201/-20X	0.63°	1.6°	2.3°	4.1°	6.7°	8.3°		LF-201/-20X	1.0°	1.4°	1.7°	2.2°	2.7°	2.9°	
LF-301/-30X		1.6°	2.3°	4.1°	6.8°	8.4°	12.2°	LF-301		1.4°	1.7°	2.2°	2.6°	2.8°	3.0°
LJ-201/-20X	0.77°	1.9°	2.7°	4.8°				LJ-201	1.1°	1.6°	1.9°	2.5°			
LJ-301/-30X		1.9°	2.6°	4.8°	7.8°	9.6°	13.8°	LJ-301		1.6°	1.9°	2.5°	3.0°	3.2°	3.5°
LL-301/-30X	1.08°	2.5°	3.5°	6.1°				LL-301	1.4°	2.0°	2.4°	3.1°			
LL-401/-40X		2.5°	3.5°	6.1°	9.8°	12.0°	17.2°	LL-401		2.0°	2.4°	3.0°	3.7°	3.9°	4.3°
LSG-401/-40X	1.62°	3.5°	4.8°	7.9°				LSG-401	1.4°	2.7°	3.2°	4.0°			

Suction Gas Return 20°C / Subcooling 0K
 ° High Discharge Temp - Additional Cooling Required

Discus™ Reciprocating Compressor Range

From 2, 3 and 8 cylinder semi-hermetic reciprocating compressors for medium/low temperature refrigeration and high temperature applications like process cooling or air-conditioning.

The key difference between Discus and traditional reciprocating technologies lies in the valve plate design. The Discus valve plate allows gas to flow into the cylinders with a minimum heat gain, while suction cavities are designed to smoothly route the gas to minimize losses. These effects lead to:

- Superior cooling capacity due to no re-expansion volume
- Up to 10% higher efficiency compared to conventional “cost-effective” reed type compressors
- Lower operating costs for the end-user

The Discus ranges from 5 to 60 hp with a displacement of 16.8 to 181. These compressors are qualified for R404A, R507, R134a, R407A, R407F and R22. All Discus compressors are designed to deliver maximum performance and reliability:

- Discus “puck” valve integrated into the valve plate for highest performance whatever the operating condition
- Positive displacement high flow oil pump guarantees high oil feeding pressure for good lubrication and bearings’ cooling



Discus Compressor

- PTFE-coated bearings for especially low friction and good protection at start-up
- Electronic motor protection module
- Availability of two motor sizes per displacement. The small motor covers all refrigeration applications while the large motor can be used in comfort, process cooling or inverter applications

Discus Compressor Line-up

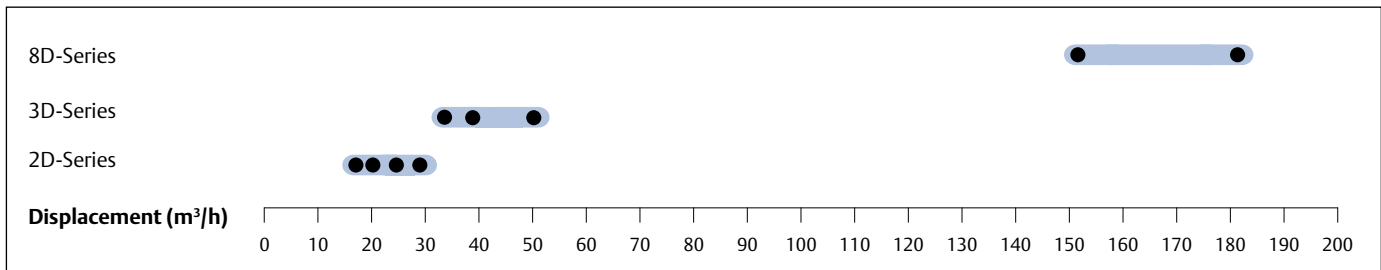

Features and Benefits

- Highest level of efficiency available on the market, whatever the refrigerant and operating condition
- Integrated oil pump and Electronic Oil Pressure Switch OPS2 for maximum reliability
- Two motor sizes per displacement, optimized for different applications
- Large operating envelope that allows medium and low temperature applications to be covered by one single model with condensing limit as low as 5°C
- Provide cooling capacity modulation either by cylinder head blocked suction or with use of frequency inverters from 25 to 60Hz
- Multi-refrigerant compressor range – one model to cover all standard refrigerants

Maximum Allowable Pressure (PS)

- Low Side PS 22.5 bar (g)/ High Side PS 28 bar (g)

Operating Envelope R404A

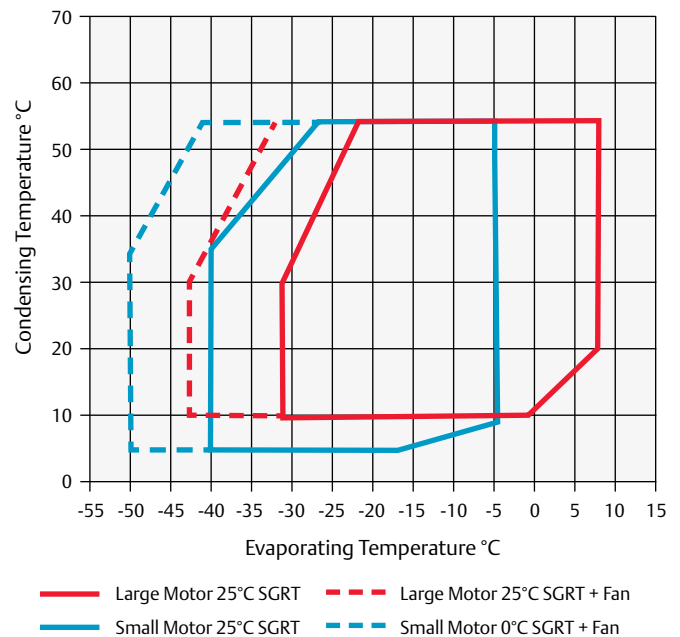

For individual model details please refer to Select Software.

Operating Envelope R134a

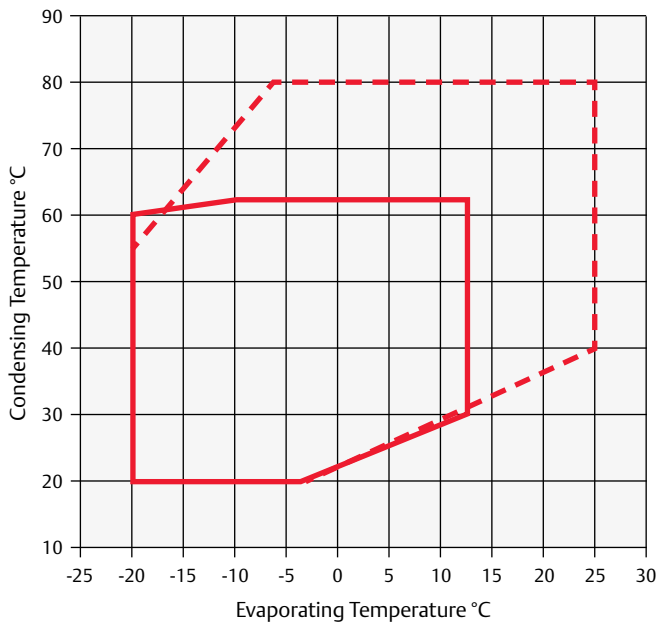

— 25°C Suction Gas Return - - - Large Motor Version

Operating Envelope R407C

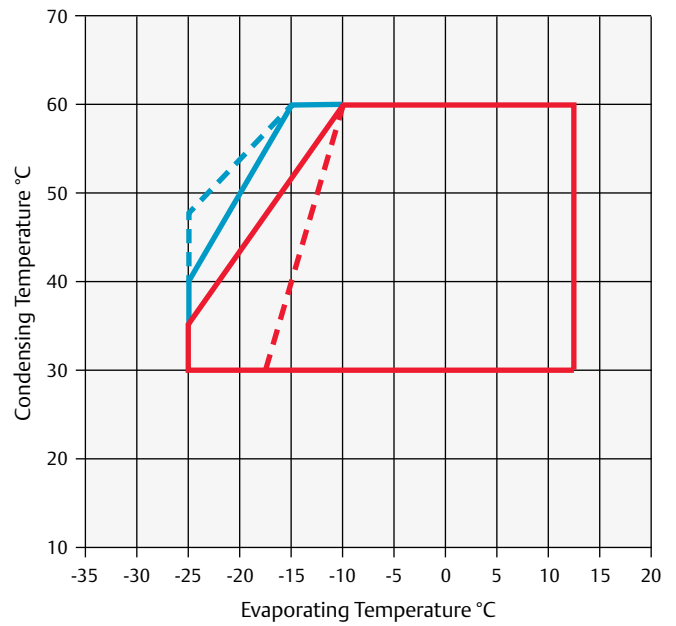

— 25°C Suction Gas Return - - - Large Motor Version
 — 20K Suction Superheat - - - Large Motor Version

Technical Overview

Models	Nominal hp	Displacement (m ³ /h)	Oil Quantity (l)	Length/Width/Height (mm)	Net Weight (kg)	Motor Version/ Code	Maximum Operating Current (A)	Locked Rotor Current (A)	Sound Pressure @ 1 m (dBA) ***
						3 Ph**	3 Ph**	3 Ph**	
2DC-50X	5	16.8	2.3	590/330/470	132	AWM	9	55	65
2DD-50X	5	19.3	2.3	590/330/470	132	AWM	10.3	55	65
2DL-40X	4	23.7	2.3	590/330/470	131	AWM	11.1	55	64
2DL-75X	7.5	23.7	2.3	590/330/470	136	AWM	13.8	70	66
2DB-50X	5	28	2.3	590/330/470	131	AWM	13.4	55	64
2DB-75X	7.5	28	2.3	590/330/470	136	AWM	16.1	70	66
3DA-50X	5	32.2	3.7	655/370/480	146	AWM	15.9	55	69
3DA-75X	7.5	32.2	3.7	680/370/480	152	AWM	17.5	106	69
3DC-75X	7.5	38	3.7	655/370/480	150	AWM	18.3	70	71
3DC-100X	10	38	3.7	680/370/480	164	AWM	20.5	121	70
3DS-100X	10	49.9	3.7	680/370/480	162	AWM	24.4	121	70
3DS-150X	15	49.9	3.7	710/370/490	166	AWM	29	125.7	70
8DH-500X	50	151	7.6	835/475/610	330	AWM	88.2	458	79
8DL-370X	37	151	7.6	835/475/610	323	AWM	74.3	349	76
8DJ-600X	60	181	7.6	835/475/610	331	AWM	108	476	79
8DT-450X	45	181	7.6	835/475/610	335	AWM	90.7	441	78

** 3 Ph: 380-420V/ 50Hz

*** @ 1m: sound pressure level at 1m distance from the compressor, free field condition

Capacity Data

Condensing Temperature: 40°C															
R134a	Cooling Capacity (kW)							R134a	Power Input (kW)						
	Evaporating Temperature (°C)								Evaporating Temperature (°C)						
Models	-45	-35	-30	-20	-10	-5	+5	Models	-45	-35	-30	-20	-10	-5	+5
2DC-50X				2.4*	4.7*	6.3*	10.3	2DC-50X				1.5*	2.0*	2.1*	2.3
2DD-50X				3.1*	5.8*	7.6*	12.2	2DD-50X				1.9*	2.3*	2.5*	2.7
2DL-40X				4.0	7.2	9.2	14.4	2DL-40X				2.3	2.8	3.1	3.4
2DL-75X				3.6*	6.8*	8.9*	14.3	2DL-75X				2.1*	2.7*	3.0*	3.3
2DB-50X				5.2	9.1	11.6	17.9	2DB-50X				2.6	3.3	3.6	4.0
2DB-75X				4.5*	8.2*	10.6*	17.0	2DB-75X				2.6*	3.3*	3.5*	3.9
3DA-50X				6.0	10.2	12.9	19.8	3DA-50X				3.0	3.7	4.0	4.4
3DA-75X				5.1*	9.6*	12.5*	20.1	3DA-75X				3.1*	3.8*	4.1*	4.5
3DC-75X				7.4	12.5	15.7	23.9	3DC-75X				3.6	4.5	4.8	5.3
3DC-100X				6.8*	12.0*	15.3*	24.2	3DC-100X				3.7*	4.5*	4.8*	5.2
3DS-100X				9.7	16.2	20.4	31.0	3DS-100X				4.7	5.9	6.4	7.2
3DS-150X				9.7*	16.3*	20.6*	31.7	3DS-150X				5.0	6.2*	6.6*	7.3
8DH-500X				28.6*	47.9*	60.9*	95.6	8DH-500X				15.5*	18.8*	20.2*	22.2
8DJ-600X				34.4*	57.5*	72.9*	114.0	8DJ-600X				18.1*	22.2*	24.0*	26.8
8DL-370X				31.4	51.6	64.5	97.3	8DL-370X				15.1	18.5	19.9	22.2
8DT-450X				38.7	62.1	77.1	115.0	8DT-450X				18.4	22.5	24.4	27.5

Suction Gas Return 20°C / Subcooling 0K

° High Discharge Temp - Additional Cooling Required

* 10K border

Condensing Temperature: 40°C															
R407A	Cooling Capacity (kW)							R407A	Power Input (kW)						
	Evaporating Temperature (°C)								Evaporating Temperature (°C)						
Models	-45	-35	-30	-20	-10	-5	+5	Models	-45	-35	-30	-20	-10	-5	+5
2DC-50X		1.7	2.4	4.5	7.8	10.0	15.5	2DC-50X		1.4	1.7	2.3	2.9	3.2	3.6
2DD-50X		2.1	3.1	5.8	9.5	12.0	18.1	2DD-50X		1.7	2.1	2.7	3.4	3.7	4.1
2DL-40X		2.5*	3.7*	7.4	11.9	14.8		2DL-40X		2.3*	2.7*	3.5	4.3	4.6	
2DL-75X				7.2	11.9	14.8	22.1	2DL-75X				3.5	4.2	4.5	4.8
2DB-50X		3.3*	4.6*	9.0	14.4	17.8		2DB-50X		2.8*	3.3*	4.3	5.2	5.6	
2DB-75X				9.0	14.3	17.7	26.1	2DB-75X				4.4	5.3	5.7	6.1
3DA-50X		3.8*	5.4*	10.4	16.4	20.2		3DA-50X		3.2*	3.8*	5.0	6.1	6.5	
3DA-75X				10.3	16.7	20.7	30.8	3DA-75X				5.0	6.0	6.4	6.9
3DC-75X		4.7*	6.5*	12.4	19.6	24.2		3DC-75X		3.9*	4.6*	6.0	7.2	7.8	
3DC-100X				12.6	20.3	25.1	37.0	3DC-100X				5.8	7.1	7.6	8.1
3DS-100X		6.4*	9.1*	16.9	26.3	32.1		3DS-100X		5.2*	6.1*	7.9	9.6	10.3	
3DS-150X				16.8	26.6	32.7	48.0	3DS-150X				7.9	9.6	10.2	11.1
8DH-500X				49.1	78.8	97.7	146.0	8DH-500X				24.1	28.8	31.0	33.9
8DL-370X		20.7*	28.8*	53.6	85.3	105.5		8DL-370X		17.4*	19.8*	25.2	30.5	33.0	
8DJ-600X				60.3	95.5	118.0	174.5	8DJ-600X				28.9	35.1	37.9	42.2
8DT-450X		24.0*	32.6*	59.6	93.3	114.5		8DT-450X		20.1*	23.2*	29.5	35.8	38.6	

Suction Gas Return 20°C / Subcooling 0K

° High Discharge Temp - Additional Cooling Required

* 10K border

Capacity Data

R407F	Cooling Capacity (kW)							R407F	Power Input (kW)						
	Evaporating Temperature (°C)								Evaporating Temperature (°C)						
Models	-45	-35	-30	-20	-10	-5	+5	Models	-45	-35	-30	-20	-10	-5	+5
2DC-50X		1.1*	1.9*	4.7	8.0	10.1	15.4	2DC-50X		1.4*	1.7*	2.4	3.1	3.3	3.6
2DD-50X		1.6*	2.6*	5.9	9.7	12.1	18.1	2DD-50X		1.7*	2.1*	2.9	3.6	3.8	4.1
2DL-40X		2.6*	3.9*	7.7	12.4	15.3		2DL-40X		2.4*	2.8*	3.7	4.5	4.9	
2DL-75X				7.6	12.5	15.6	23.4	2DL-75X				3.7	4.4	4.6	5.0
2DB-50X		3.9*	5.4*	9.8	15.3	18.8		2DB-50X		2.9*	3.4*	4.5	5.4	5.8	
2DB-75X				9.6	15.3	18.9	27.9	2DB-75X				4.6	5.6	6.0	6.3
3DA-50X		4.3*	6.1*	11.3	17.9	22.1		3DA-50X		3.4*	4.0*	5.2	6.4	6.8	
3DA-75X				11.4	18.4	22.8	33.8	3DA-75X				5.2	6.3	6.8	7.2
3DC-75X		5.4*	7.5*	13.8	21.6	26.6		3DC-75X		4.2*	4.8*	6.2	7.5	8.1	
3DC-100X				14.0	22.1	27.3	40.2	3DC-100X				6.1	7.4	7.9	8.5
3DS-100X		7.3*	10.2*	18.4	28.8	35.3		3DS-100X		5.5*	6.4*	8.3	10.0	10.8	
3DS-150X				18.8	29.7	36.4	53.2	3DS-150X				8.2	10.1	10.8	11.8
8DL-370X		20.8*	28.9*	53.6	85.3	105.5		8DL-370X		17.4*	19.8*	25.2	30.5	33.0	
8DH-500X				53.0	84.6	105.0	156.5	8DH-500X				25.8	30.5	32.2	34.9
8DJ-600X				63.7	101.0	125.0	187.5	8DJ-600X				30.6	36.9	39.8	43.9
8DT-450X		26.8*	35.9*	64.1	100.5	123.5		8DT-450X		21.8*	24.7*	31.2	37.7	40.7	

Suction Gas Return 20°C / Subcooling 0K

° High Discharge Temp - Additional Cooling Required

* 10K border

Condensing Temperature: 40°C															
R404A	Cooling Capacity (kW)							R404A	Power Input (kW)						
	Evaporating Temperature (°C)								Evaporating Temperature (°C)						
Models	-45	-35	-30	-20	-10	-5	+5	Models	-45	-35	-30	-20	-10	-5	+5
2DC-50X		2.1°	3.0°	5.4	8.8	11.0	16.5	2DC-50X		1.7°	2.1°	2.7	3.3	3.6	3.8
2DD-50X		2.8°	3.9°	6.8	10.8	13.2	19.3	2DD-50X		2.2°	2.5°	3.3	3.9	4.1	4.3
2DL-40X	1.2*	3.8	5.1	8.5	13.2	16.2		2DL-40X	1.8*	2.7	3.2	4.1	4.9	5.3	
2DL-75X		3.6°	4.9°	8.4	13.4	16.5	24.1	2DL-75X		2.7°	3.1°	4.0	4.8	5.1	5.5
2DB-50X	1.7*	4.6	6.2	10.4	16.0	19.4		2DB-50X	2.2*	3.2	3.8	4.9	5.9	6.3	
2DB-75X		4.9°	6.4°	10.5	16.2	19.8	28.6	2DB-75X		3.5°	4.0°	5.1	6.1	6.5	7.0
3DA-50X	2.0*	5.7	7.4	11.9	17.9	21.7		3DA-50X	2.7*	4.0	4.7	5.9	6.9	7.3	
3DA-75X		5.2°	7.2°	12.2	18.9	23.1	33.4	3DA-75X		3.9°	4.6°	5.9	6.9	7.3	7.6
3DC-75X	2.8*	7.0	9.1	14.4	21.6	26.1		3DC-75X	3.4*	4.9	5.6	7.0	8.2	8.7	
3DC-100X		6.6°	8.9°	14.9	22.7	27.5	39.3	3DC-100X		4.6°	5.4°	6.9	8.1	8.5	8.9
3DS-100X	4.0*	9.6	12.5	19.8	29.5	35.5		3DS-100X	4.7*	6.5	7.5	9.4	11.1	11.7	
3DS-150X		9.1°	12.2°	19.9	30.2	36.5	51.9	3DS-150X		6.3°	7.4°	9.4	11.1	11.6	12.0
8DH-500X		26.3°	35.7°	58.8	89.3	108.0	153.5	8DH-500X		19.1°	22.1°	27.9	32.8	34.7	37.3
8DL-370X	10.8*	28.0	36.9	59.3	88.8	106.5		8DL-370X	13.2*	19.5	22.4	27.9	32.7	34.7	
8DJ-600X		32.7°	44.0°	71.3	107.0	128.5	181.0	8DJ-600X		23.0°	26.8°	33.7	39.5	41.9	45.5
8DT-450X	14.2*	34.7	44.9	70.6	105.0	125.5		8DT-450X	16.9*	23.7	27.2	34.0	40.2	42.8	

Suction Gas Return 20°C / Subcooling 0K

° High Discharge Temp - Additional Cooling Required

* 10K border

Capacity Data

Condensing Temperature: 40°C															
R407C		Cooling Capacity (kW)						R407C		Power Input (kW)					
		Evaporating Temperature (°C)								Evaporating Temperature (°C)					
Models	-45	-35	-30	-20	-10	-5	+5	Models	-45	-35	-30	-20	-10	-5	+5
2DC-50X				4.1	7.4	9.6	15.1	2DC-50X				2.1	2.7	2.9	3.3
2DD-50X				4.9	8.7	11.2	17.4	2DD-50X				2.5	3.1	3.4	3.8
2DL-75X				6.3	10.9	13.9	21.5	2DL-75X				3.1	3.9	4.2	4.8
2DB-75X				8.3	13.5	16.9	25.4	2DB-75X				3.9	4.7	5.1	5.7
3DA-75X				9.2	15.4	19.5	29.9	3DA-75X				4.5	5.5	5.9	6.4
3DC-100X				11.3	18.5	23.2	35.3	3DC-100X				5.3	6.4	6.9	7.6
3DS-150X				15.8	24.8	30.8	46.0	3DS-150X				7.4	8.8	9.4	10.3
8DH-500X				40.0*	70.6	88.9	135.0	8DH-500X				22.0*	26.6	28.7	31.8
8DJ-600X				47.9*	84.6	106.5	162.0	8DJ-600X				25.9*	31.8	34.6	39.2

Suction Gas Return 20°C / Subcooling 0K

* 10K border

Condensing Temperature: 40°C															
R22		Cooling Capacity (kW)						R22		Power Input (kW)					
		Evaporating Temperature (°C)								Evaporating Temperature (°C)					
Models	-45	-35	-30	-20	-10	-5	+5	Models	-45	-35	-30	-20	-10	-5	+5
2DC-500/-50X				4.9	8.4	10.6	15.9	2DC-500/-50X				2.4	2.9	3.1	3.4
2DD-500/-50X				5.8	9.8	12.3	18.4	2DD-500/-50X				2.8	3.4	3.6	3.9
2DL-400 DC	1.4°	3.1°	4.3°	7.4°	11.7°			2DL-400 DC	1.7°	2.5°	2.9°	3.7°	4.4°		
2DL-750/-75X				7.4	12.2	15.2	22.7	2DL-750/-75X				3.5	4.2	4.5	4.9
2DB-500 DC	1.9°	4.0°	5.4°	9.1°	14.2°			2DB-500 DC	2.3°	3.2°	3.6°	4.5°	5.2°		
2DB-750/-75X				9.5	15.0	18.4	26.7	2DB-750/-75X				4.3	5.1	5.4	5.8
3DA-500 DC	2.1°	4.5°	6.0°	10.1°				3DA-500 DC	2.3°	3.4°	4.0°	5.0°			
3DA-750/-75X				10.7	17.3	21.4	31.6	3DA-750/-75X				5.0	5.9	6.3	6.6
3DC-750 DC	2.7°	5.4°	7.3°	12.5°				3DC-750 DC	2.8°	4.0°	4.7°	6.1°			
3DC-1000/-100X				12.9	20.6	25.4	37.2	3DC-1000/-100X				5.9	7.0	7.4	7.8
3DS-1000 DC	3.4°	7.5°	10.2°	17.2°				3DS-1000 DC	3.9°	5.7°	6.6°	8.4°			
3DS-1500/-150X				17.7	27.4	33.4	48.3	3DS-1500/-150X				8.1	9.4	10.0	10.6
8DH-5000/-500X				48.4*	79.3	97.6	143.0	8DH-5000/-500X				24.6*	28.9	30.7	33.1
8DJ-6000/-600X				58.0*	95.1	117.0	171.5	8DJ-6000/-600X				29.2*	34.8	37.3	41.0

Suction Gas Return 20°C / Subcooling 0K

° High Discharge Temp - Additional Cooling Required

* 10K border



Discus™ Digital (3Cylinder) Reciprocating Compressor

With Continuous Capacity Modulation

Discus Digital series with 3 cylinder compressors provide an alternative means of continuous modulation to inverter. Digital modulation is the most simple and precise method of capacity control and helps to contain applied costs associated with modulation.

Digital technology is based on controlling a high-cycle solenoid valve fitted on one of the cylinder heads based on cycle time. The valve actuates a piston that controls the flow of gas into the suction area of the Discus valve plate.

The compressor always runs at constant speed which resolves the challenges related to oil return, mechanical and electrical stress on the system.



Discus Digital 3 Cylinder Compressor

Discus Digital Compressor Line-up

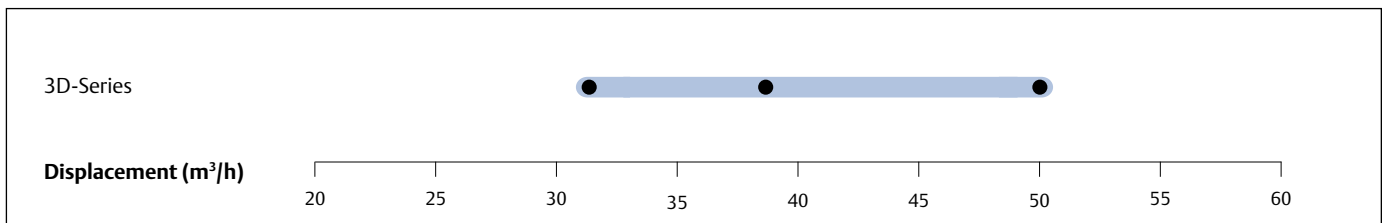

Features and Benefits

- Range of 6 models from 32 to 50 m³/h
- Compatible with R404A, R407A, R407F and R134a
- Continuous modulation from 10–100% ensuring a perfect match of capacity and power to refrigeration load
- Economical and reliable alternative to frequency inverters
- Precise suction pressure control with associated energy savings and stable evaporating temperatures
- Quick and easy integration into refrigeration equipment, similar to any other standard compressor
- Possibility to easily retrofit existing installations with digital cylinder head kit
- No vibrations or mechanical stress on system piping and compressor parts
- Reduced compressor cycling for longer contactor and compressor life

Operating Envelope R404A

With Small Motor

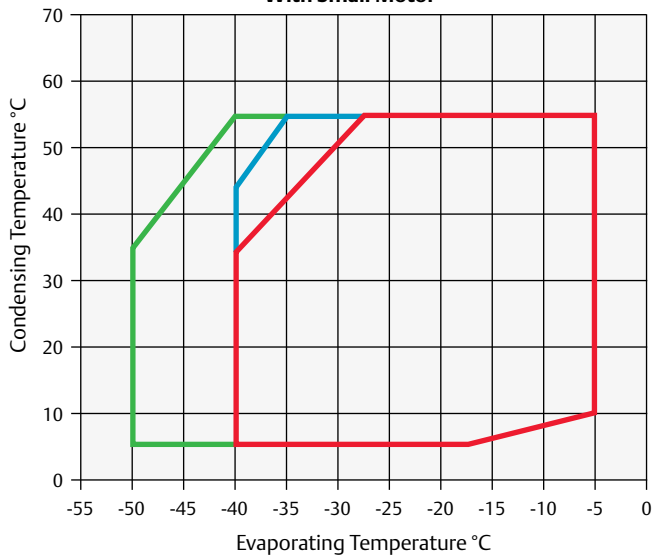

— 25°C Suction Gas Return — 0°C Suction Gas Return
 — 0°C Suction Gas Return + Fan

With Large Motor

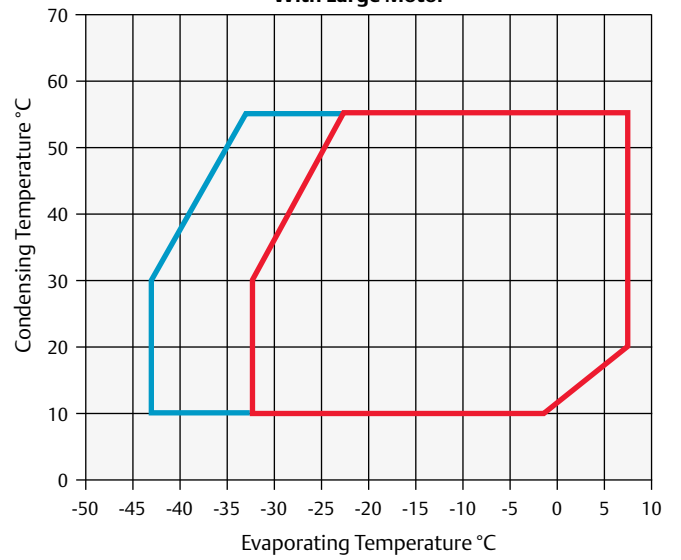

— 25°C Suction Gas Return — 25°C Suction Gas Return + Fan

Operating Envelope R134a

With Small Motor

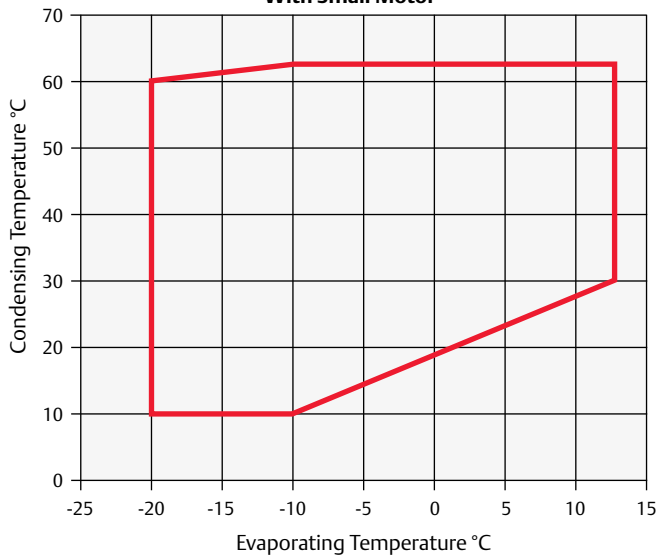

— 25°C Suction Gas Return

With Large Motor

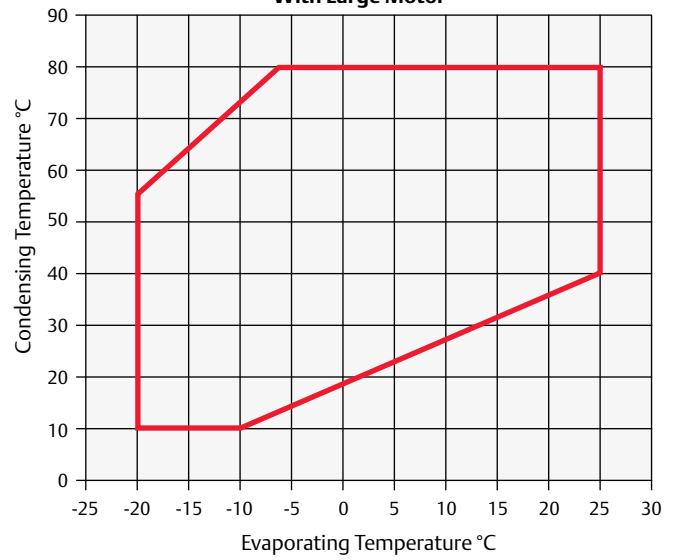

— 20K Suction Superheat

Technical Overview

Models	Nominal hp	Displacement (m ³ /h)	Oil Quantity (l)	Length/Width/Height (mm)	Net Weight (kg)	Motor Version/ Code	Maximum Operating Current (A)	Locked Rotor Current (A)	Sound Pressure @1 m (dBA)***
						3 Ph**	3 Ph**	3 Ph**	
3DAD-50X	5	32.2	3.7	655/370/480	146	AWM	15.7	55	65
3DAD-75X	7.5	32.2	3.7	680/370/480	152	AWM	18.6	106	69
3DCD-75X	7.5	38	3.7	655/370/480	150	AWM	18.5	70	67
3DCD-100X	10	38	3.7	680/370/480	164	AWM	21.6	121	70
3DSD-100X	10	49.9	3.7	680/370/480	162	AWM	24.4	121	69
3DSD-150X	15	49.9	3.7	710/370/490	166	AWM	29.7	129	70

** 3 Ph: 380-420V/ 50Hz

*** @ 1m: sound pressure level at 1m distance from the compressor, free field condition

Capacity Data

Condensing Temperature: 40°C															
R134a	Cooling Capacity (kW)							R134a	Power Input (kW)						
	Evaporating Temperature (°C)								Evaporating Temperature (°C)						
	Models	-45	-35	-30	-20	-10	-5		+5	Models	-45	-35	-30	-20	-10
3DAD-50X				6.3	10.4	13.0	19.8	3DAD-50X				3.0	3.8	4.1	4.5
3DAD-75X				5.6*	9.8*	12.6*	20.0	3DAD-75X				3.1*	3.8*	4.1*	4.5
3DCD-75X				7.5	12.4	15.6	23.5	3DCD-75X				3.6	4.5	4.9	5.4
3DCD-100X				6.8*	11.9*	15.2*	23.8	3DCD-100X				3.7*	4.5*	4.8*	5.2
3DSD-100X				10.2	16.6	20.6	31.0	3DSD-100X				4.8	6.0	6.4	7.1
3DSD-150X				9.1*	15.7*	19.9*	31.0	3DSD-150X				4.8*	6.0*	6.6*	7.3

Suction Gas Return 20°C, Subcooling 0K, 100% loaded

High Discharge Temp - Additional Cooling Required

* 10K border

Condensing Temperature: 40°C															
R407A	Cooling Capacity (kW)							R407A	Power Input (kW)						
	Evaporating Temperature (°C)								Evaporating Temperature (°C)						
	Models	-45	-35	-30	-20	-10	-5		+5	Models	-45	-35	-30	-20	-10
3DAD-50X		3.7*	5.3*	10.3	16.2	19.9		3DAD-50X		3.2*	3.8*	5.0	6.1	6.5	
3DAD-75X				10.2	16.5	20.4	30.4	3DAD-75X				5.0	6.0	6.4	6.9
3DCD-75X		4.6*	6.4*	12.3	19.4	23.8		3DCD-75X		3.9*	4.6*	6.0	7.2	7.8	
3DCD-100X				12.4	20.0	24.7	36.6	3DCD-100X				5.8	7.1	7.6	8.3
3DSD-100X		6.3*	8.9*	16.7	25.9	31.6		3DSD-100X		5.2*	6.1*	7.9	9.6	10.3	
3DSD-150X				16.5	26.2	32.2	47.6	3DSD-150X				7.8	9.6	10.3	11.2

Suction Gas Return 20°C, Subcooling 0K, 100% loaded

High Discharge Temp - Additional Cooling Required

* 10K border

Capacity Data

Condensing Temperature: 40°C															
R407F	Cooling Capacity (kW)							R407F	Power Input (kW)						
	Evaporating Temperature (°C)								Evaporating Temperature (°C)						
Models	-45	-35	-30	-20	-10	-5	+5	Models	-45	-35	-30	-20	-10	-5	+5
3DAD-50X		4.3*	6.0*	10.7*	17.8	21.9		3DAD-50X		3.4*	4.0*	5.2*	6.4	6.8	
3DAD-75X				10.7*	18.2	22.6	33.6	3DAD-75X				5.2*	6.3	6.8	7.2
3DCD-75X		5.3*	7.4*	13.1*	21.5	26.4		3DCD-75X		4.0*	4.8*	6.2*	7.5	8.1	
3DCD-100X				13.3*	21.9	27.0	39.8	3DCD-100X				6.0*	7.3	7.9	8.6
3DSD-100X		7.2*	10.0*	17.4*	28.5	35.0		3DSD-100X		5.4*	6.3*	8.3*	10.1	10.8	
3DSD-150X				17.7*	29.2	36.0	53.0	3DSD-150X				8.2*	10.1	10.9	11.9

Suction Gas Return 20°C, Subcooling 0K, 100% loaded
 High Discharge Temp - Additional Cooling Required
 * 10K border

Condensing Temperature: 40°C															
R404A	Cooling Capacity (kW)							R404A	Power Input (kW)						
	Evaporating Temperature (°C)								Evaporating Temperature (°C)						
Models	-45	-35	-30	-20	-10	-5	+5	Models	-45	-35	-30	-20	-10	-5	+5
3DAD-50X	2.0*°	5.6	7.3	11.8	17.8	21.5		3DAD-50X	2.7*°	4.0	4.6	5.9	6.9	7.3	
3DAD-75X		5.1°	7.1°	11.9	18.3	22.2	31.8	3DAD-75X		3.7°	4.4°	5.7	6.8	7.2	7.5
3DCD-75X	2.5*°	6.8	8.8	14.1	21.2	25.6		3DCD-75X	3.4*°	4.8	5.5	7.0	8.2	8.6	
3DCD-100X		6.4°	8.6°	14.3	21.8	26.5	37.9	3DCD-100X		4.5°	5.3°	6.8	8.0	8.4	8.9
3DSD-100X	3.6*°	9.2	11.9	18.9	28.3	34.1		3DSD-100X	4.5*°	6.4	7.4	9.3	10.9	11.6	
3DSD-150X		9.3°	12.1°	19.1	28.6	34.6	49.3	3DSD-150X		6.5°	7.3°	9.2	11.0	11.6	12.3

Suction Gas Return 20°C, Subcooling 0K, 100% loaded
 High Discharge Temp - Additional Cooling Required
 * 10K border

Condensing Temperature: 40°C															
R407C	Cooling Capacity (kW)							R407C	Power Input (kW)						
	Evaporating Temperature (°C)								Evaporating Temperature (°C)						
Models	-45	-35	-30	-20	-10	-5	+5	Models	-45	-35	-30	-20	-10	-5	+5
3DAD-75X				9.6	15.8	19.7	29.6	3DAD-75X				4.7	5.7	6.1	6.5
3DCD-100X				11.8	19.1	23.7	35.1	3DCD-100X				5.4	6.7	7.2	7.7
3DSD-150X				15.6	24.9	30.9	46.2	3DSD-150X				7.3	9.0	9.7	10.6

Suction Gas Return 20°C, Subcooling 0K, 100% loaded
 High Discharge Temp - Additional Cooling Required
 * 10K border

Copeland™ Stream With CoreSense™ Diagnostics, Semi-Hermetic Reciprocating Compressors For HFC

Stream series 4 and 6 cylinder compressors provide best-in-class performance, thereby significantly reducing cost of operation and environmental impact compared to competing products. With advanced protection and diagnostics features for system reliability, reduced service costs and increased equipment uptime, Stream series is built to last in today's modern changing world.



Copeland Stream Compressor
Designed to Deliver Best-in-Class Performance

Stream Compressor Line-up

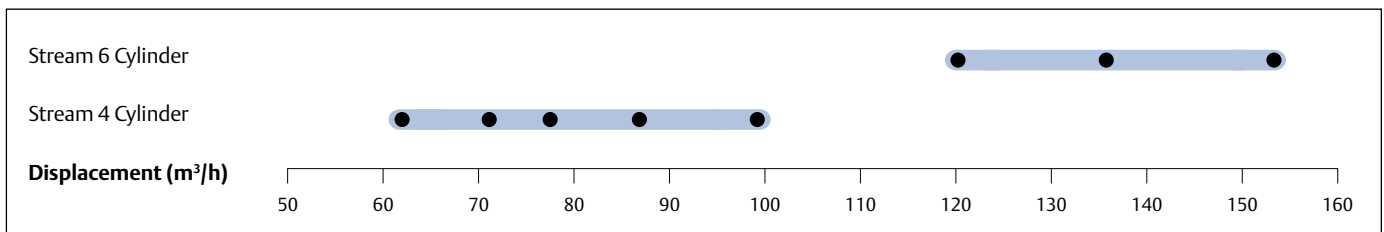

Features and Benefits

- Range of 16 models from 62 to 153m³/h
- Best-in-class seasonal efficiencies, up to 15% higher than market standard
- Multi-refrigerant compressor as it is compatible with R404A, R134a, R407F, R407A/C and R22
- Stepless capacity modulation by means of inverter or Digital modulation
- Wide Operating Envelope covering low- and medium-temperature refrigeration without cooling fan
- Reduced sound level, dimensions and weight by up to 45 kg

CoreSense Diagnostics Features

- Motor and oil protection
- Storage of compressor asset and advanced runtime information
- Runtime/alarm signalling using multi-colour LED flash-codes
- Communication to system controller via Modbus®
- Individual compressor power monitoring

Operating Envelope R404A

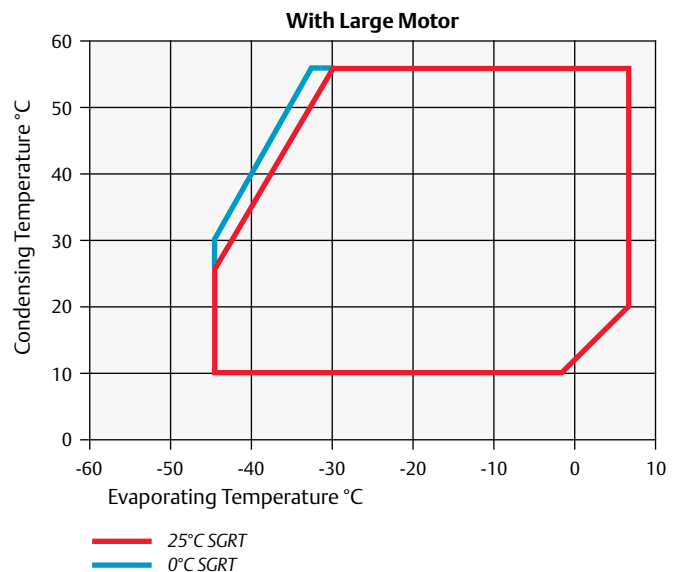
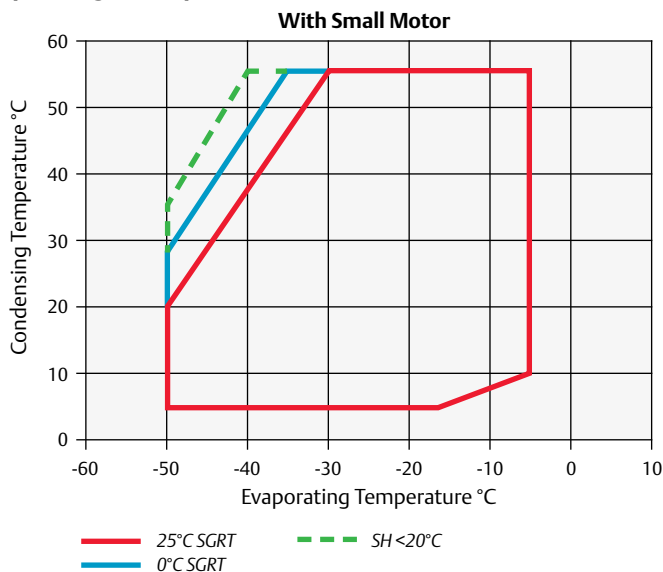

Maximum Allowable Pressure (PS)

- Low Side PS 22.5 bar(g) / High Side PS 28 bar(g)

Operating Envelope R134a

With Small Motor

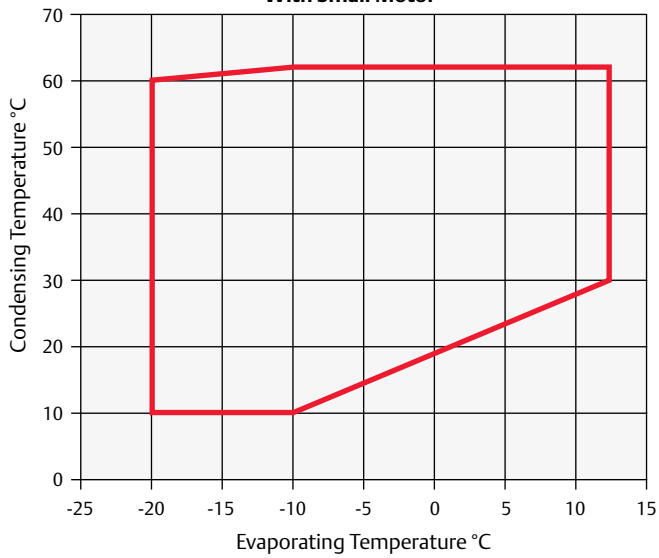

— 25°C Suction Gas Return

With Large Motor

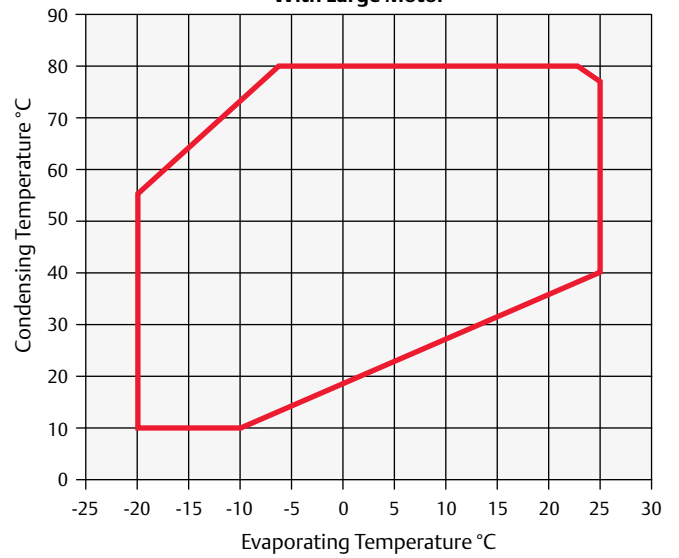

— 20K Suction Superheat

Operating Envelope R407A

With Small Motor

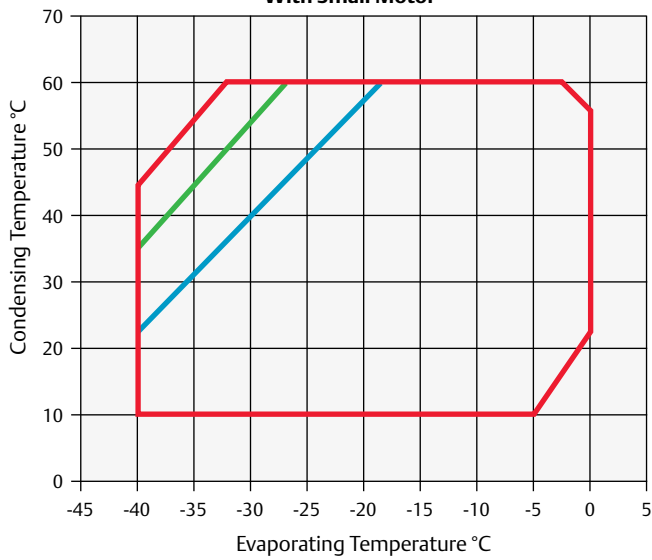

— 20K Suction Superheat — 20°C Suction Gas Return
— 0°C Suction Gas Return

With Large Motor

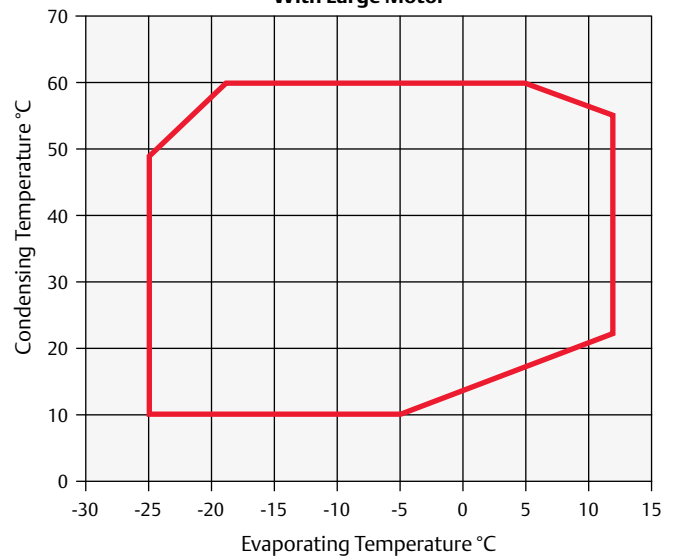

— 20°C Suction Gas Return

Operating Envelope R407C

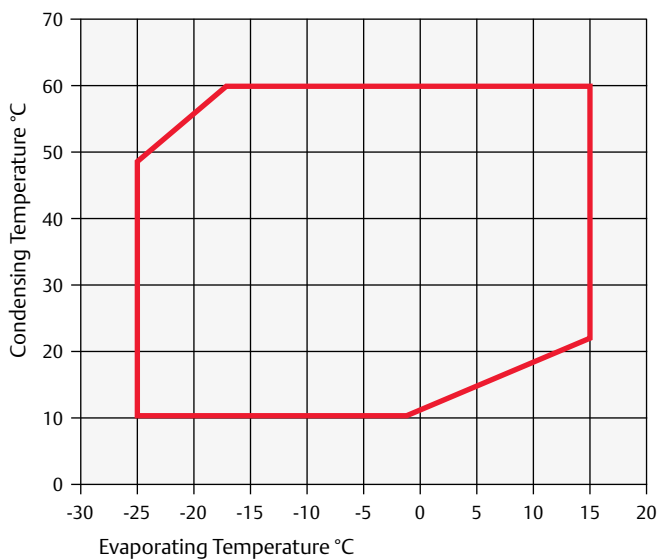

— 20°C Suction Gas Return

For individual model details please refer to Select Software.

Operating Envelope R407F

With Small Motor

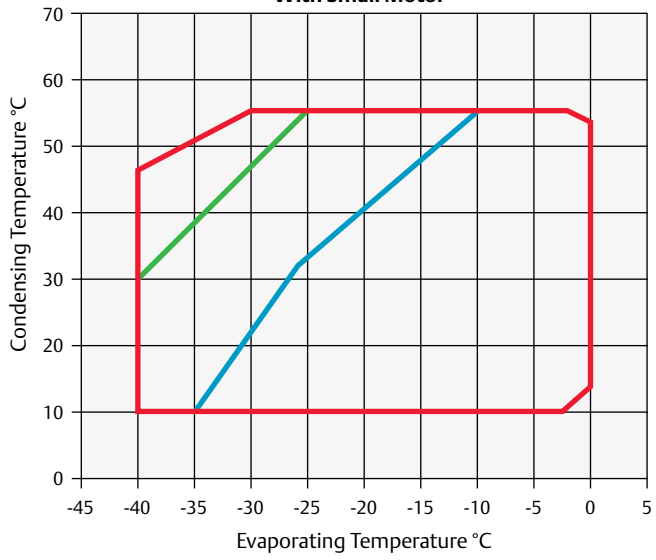

- 20K Suction Superheat OR 20°C Suction Gas Return
- 20°C Suction Gas Return
- 0°C Suction Gas Return

With Large Motor

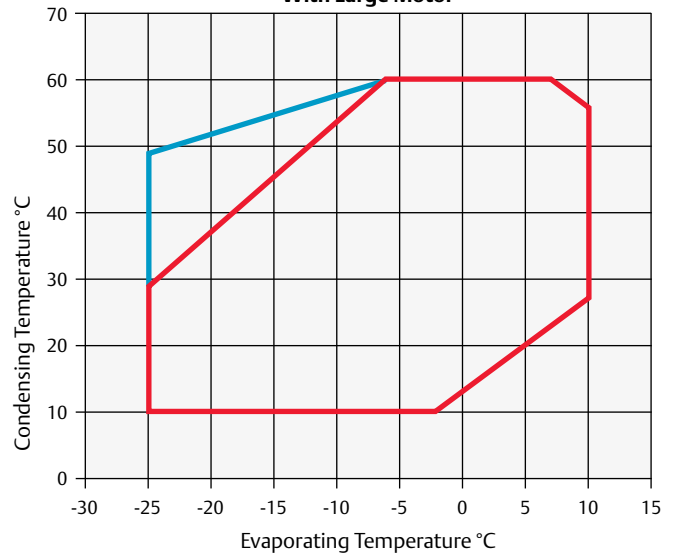

- 20°C Suction Gas Return
- 0°C Suction Gas Return

Technical Overview

Models	Nominal hp	Displacement (m ³ /h)	Oil Quantity (l)	Length/Width/Height (mm)	Net Weight (kg)	Motor Version/ Code	Maximum Operating Current (A)	Locked Rotor Current (A)	Sound Pressure @1 m (dB(A)) ***
						3 Ph**	3 Ph**	3 Ph**	
4MF-13X	13	61.7	3.3	638/501/452	177	AWM	30.8	105	70
4MA-22X	22	61.7	3.3	638/501/452	177	AWM	36.3	175	75
4ML-15X	15	71.4	3.3	638/501/452	180	AWM	35.4	156	71
4MH-25X	25	71.4	3.3	657/501/452	187	AWM	41.6	199	75
4MM-20X	17	78.2	3.3	657/501/452	182	AWM	39	175	71
4MI-30X	27	78.2	3.3	657/501/452	188	AWM	46.6	221	75
4MT-22X	22	87.7	3.3	657/501/452	183	AWM	44.5	175	73
4MJ-33X	33	87.7	3.3	657/501/452	190	AWM	52.9	221	74
4MU-25X	25	99.4	3.3	657/501/452	186	AWM	51.9	199	72
4MK-35X	32	99.4	3.3	688/501/452	202	AWM	61.1	255	74
6MM-30X	27	120.5	3.3	695/547/450	215	AWM	59.7	255	78
6MI-40X	35	120.5	3.3	695/547/450	219	AWM	71.4	304	78
6MT-35X	32	135	3.3	725/547/450	221	AWM	67.3	255	77
6MJ-45X	40	135	3.3	725/547/450	223	AWM	81.5	304	79
6MU-40X	40	153	3.3	757/547/450	225	AWM	75.8	306	78
6MK-50X	50	153	3.3	773/547/450	230	AWM	92.9	393	80

** 3 Ph: 380-420V/ 50Hz

*** @ 1m: sound pressure level at 1m distance from the compressor, free field condition

Capacity Data

Condensing Temperature: 40°C															
R134a	Cooling Capacity (kW)							R134a	Power Input (kW)						
	Evaporating Temperature (°C)								Evaporating Temperature (°C)						
	Models	-45	-35	-30	-20	-10	-5		+5	Models	-45	-35	-30	-20	-10
4MA-22X				13.1	21.3	26.6	40.1	4MA-22X				5.9	7.3	7.9	8.7
4MF-13X				12.2	20.4	25.6	38.9	4MF-13X				5.8	7.2	7.8	8.7
4MH-25X				15	24.6	30.7	46.4	4MH-25X				7	8.7	9.4	10.4
4ML-15X				15	24.5	30.5	46	4ML-15X				6.9	8.5	9.3	10.4
4MI-30X				16.8	27.1	33.7	50.7	4MI-30X				7.6	9.4	10.3	11.4
4MM-20X				16.6	27	33.6	50.3	4MM-20X				7.7	9.4	10.2	11.4
4MJ-33X				18.9	30.3	37.6	56.4	4MJ-33X				8.7	10.7	11.5	12.8
4MT-22X				19	30.6	38.1	57.2	4MT-22X				8.7	10.8	11.7	13
4MK-35X				21	34	42.2	63.3	4MK-35X				9.7	12.2	13.3	14.9
4MU-25X				20.7	33.9	42.3	63.8	4MU-25X				9.8	12.2	13.3	15
6MI-40X				24.8	40.2	50.2	76	6MI-40X				12	14.6	15.8	17.8
6MM-30X				25.2	40.7	50.7	76.1	6MM-30X				11.7	14.6	15.8	17.7
6MJ-45X				28.5	45.6	56.7	85.3	6MJ-45X				13	16.2	17.8	20.3
6MT-35X				28.5	46	57.1	85.2	6MT-35X				13.3	16.5	17.9	20
6MK-50X				29.8	49.1	61.7	94.3	6MK-50X				15.2	18.8	20.5	23.3
6MU-40X				31.5	50.6	62.9	94.5	6MU-40X				14.6	18.4	20.1	23

Suction Gas Return 20°C, Subcooling 0K

* Suction Superheat 10K, Subcooling 0K

Capacity Data

Condensing Temperature: 40°C															
R407A	Cooling Capacity (kW)							R407A	Power Input (kW)						
	Evaporating Temperature (°C)								Evaporating Temperature (°C)						
Models	-45	-35	-30	-20	-10	-5	+5	Models	-45	-35	-30	-20	-10	-5	+5
4MF-13X		7.1*	10.3*	19.9	31.2	38.3		4MF-13X		6.1*	7.3*	9.7	11.8	12.7	
4MA-22X				20.3	32.6	40.3	59.9	4MA-22X				9.5	11.7	12.6	14
4ML-15X		9.2*	13.0*	24.3	38	46.6		4ML-15X		7.4*	8.8*	11.4	13.8	14.9	
4MH-25X				23.8	37.8	46.7	69.2	4MH-25X				11.4	13.7	14.6	15.9
4MM-20X		10.4*	14.5*	26.7	41.6	51		4MM-20X		8.3*	9.7*	12.7	15.3	16.5	
4MI-30X				26.7	42.1	51.9	76.5	4MI-30X				12.6	15	16.1	17.8
4MT-22X		11.2*	15.5*	28.7	44.7	54.8		4MT-22X		9.4*	11.1*	14.5	17.5	18.9	
4MJ-33X				29.7	46.8	57.7	85.1	4MJ-33X				14.2	17	18.2	20.1
4MU-25X		12.3*	17.3*	32.6	50.9	62.4		4MU-25X		10.6*	12.4*	16.2	19.9	21.6	
4MK-35X				33.5	52.6	64.7	95.1	4MK-35X				16.2	19.5	20.9	23.4
6MM-30X		15.1*	21.2*	39.7	61.9	75.8		6MM-30X		12.6*	14.9*	19.4	23.6	25.5	
6MI-40X				40.8	64.2	79	116.5	6MI-40X				19.3	23.3	25	27.6
6MT-35X		18.4*	25.1*	45.7	71	86.9		6MT-35X		14.5*	16.8*	21.9	26.9	29.1	
6MJ-45X				45.4	71.4	87.9	129.5	6MJ-45X				21.5	26.1	28	31
6MU-40X		20.9*	27.8*	50.3	78.7	96.7		6MU-40X		16.6*	19.0*	24.4	30.1	32.8	
6MK-50X				50.6	79.4	97.6	143.5	6MK-50X				24.4	29.8	32.3	36.4

Suction Gas Return 20°C, Subcooling 0K

* Suction Superheat 10K, Subcooling 0K

Condensing Temperature: 40°C															
R407F	Cooling Capacity (kW)							R407F	Power Input (kW)						
	Evaporating Temperature (°C)								Evaporating Temperature (°C)						
Models	-45	-35	-30	-20	-10	-5	+5	Models	-45	-35	-30	-20	-10	-5	+5
4MF-13X		7.8*	11.1*	19.7*	32.5	39.9		4MF-13X		6.5*	7.7*	10.2*	12.4	13.3	
4MA-22X				20.7*	34.8	43	63.8	4MA-22X				10.2*	12.4	13.2	14.4
4MH-25X				24.2*	40.4	49.9	73.8	4MH-25X				11.9*	14.4	15.4	16.8
4ML-15X		9.9*	13.8*	24.2*	39.8	48.9		4ML-15X		7.8*	9.2*	12.0*	14.6	15.7	
4MM-20X		11.0*	15.3*	26.6*	43.5	53.4		4MM-20X		8.7*	10.3*	13.3*	16.0	17.2	
4MI-30X				26.9*	44.4	54.8	80.7	4MI-30X				13.1*	15.8	17.0	18.6
4MT-22X		12.7*	17.4*	29.9*	48.5	59.5		4MT-22X		10.0*	11.7*	15.1*	18.3	19.7	
4MJ-33X				30.2*	49.5	60.9	89.8	4MJ-33X				14.8*	17.8	19.2	21.1
4MU-25X		14.0*	19.3*	33.3*	54.6	66.9		4MU-25X		11.2*	13.2*	17.2*	21.0	22.8	
4MK-35X				33.7*	55.3	68.3	101	4MK-35X				16.8*	20.4	22.1	24.4
6MM-30X		17.2*	23.7*	40.7*	66	80.7		6MM-30X		13.6*	15.8*	20.4*	24.8	26.7	
6MI-40X				41.2*	67.9	83.5	122.5	6MI-40X				20.2*	24.4	26.2	28.9
6MT-35X		19.8*	27.0*	45.8*	74.1	90.4		6MT-35X		15.3*	18.0*	23.1*	28.0	30.3	
6MJ-45X				45.8*	75.2	92.6	136	6MJ-45X				22.9*	27.6	29.7	32.8
6MU-40X		20.1*	27.7*	48.5*	82.7	101.5		6MU-40X		16.9*	19.8*	25.9*	31.7	34.4	
6MK-50X				51.3*	84.5	104	153.5	6MK-50X				25.8*	31.3	33.7	37.5

Suction Gas Return 20°C, Subcooling 0K

* Suction Superheat 10K, Subcooling 0K

Capacity Data

Condensing Temperature: 40°C															
R404A	Cooling Capacity (kW)							R404A	Power Input (kW)						
	Evaporating Temperature (°C)								Evaporating Temperature (°C)						
Models	-45	-35	-30	-20	-10	-5	+5	Models	-45	-35	-30	-20	-10	-5	+5
4MA-22X		10.45	14.3	23.6	36	43.5	62	4MA-22X		7.3	8.6	11	13	13.7	14.7
4MF-13X	3.6*	10.65	14.	22.8	34.8	42.2		4MF-13X	5.0*	7.4	8.7	11	13	13.9	
4MH-25X		12.4	16.7	27.5	42.2	51.3	73.6	4MH-25X		8.6	10.1	13	15.4	16.3	17.5
4ML-15X	4.8*	13.3	17.4	27.9	42	50.8		4ML-15X	6.3*	9	10.5	13.3	15.8	16.7	
4MI-30X		14.4	19.4	31.2	46.8	56.3	79.5	4MI-30X		9.8	11.5	14.5	17	18	19.45
4MM-20X	5.7*	15.1	19.6	30.9	46.1	55.4		4MM-20X	7.1*	10.1	11.6	14.6	17	18.2	
4MJ-33X		16.2	21.4	34.6	52.4	63.4	90.4	4MJ-33X		10.9	12.6	16	19	20.2	21.8
4MT-22X	6.7*	17	21.9	34.7	52	62.7		4MT-22X	8.0*	11.5	13.2	16.6	19.5	20.7	
4MK-35X		18.3	24	38.8	58.9	71.3	102	4MK-35X		12.6	14.6	18.5	22	23.5	25.7
4MU-25X	7.2*	18.6	24.1	38.5	58.1	70.2		4MU-25X	9.0*	12.9	14.9	18.8	22.3	23.7	
6MI-40X		21.9	28.9	46.7	70.8	85.8	122.5	6MI-40X		15.2	17.6	22.2	26.1	27.7	30.1
6MM-30X	8.9*	22.7	29.3	46.5	70.2	85.1		6MM-30X	11.0*	15.7	18	22.5	26.3	27.8	
6MJ-45X		24.3	32.3	52.5	79.5	96.1	136.5	6MJ-45X		16.8	19.6	24.9	29.5	31.4	33.9
6MT-35X	10.3*	25.6	33	52.5	79.3	95.9		6MT-35X	12.3*	17.5	20.1	25.3	29.7	31.5	
6MK-50X		27.3	36.3	58.7	88.6	107	152	6MK-50X		19.4	22.5	28.3	33.5	35.9	39.9
6MU-40X	11.0*	28.4	36.8	58.7	89	108		6MU-40X	13.8*	19.7	22.7	28.5	33.6	35.8	

Suction Gas Return 20°C, Subcooling 0K

* Suction Superheat 10K, Subcooling 0K

Condensing Temperature: 40°C															
R407C	Cooling Capacity (kW)							R407C	Power Input (kW)						
	Evaporating Temperature (°C)								Evaporating Temperature (°C)						
Models	-45	-35	-30	-20	-10	-5	+5	Models	-45	-35	-30	-20	-10	-5	+5
4MA-22X				19.3	30.7	37.8	55.5	4MA-22X				9.2	11.2	12	12.9
4MH-25X				22.3	35.7	44.1	65.2	4MH-25X				10.7	12.9	13.8	15
4MI-30X				25.2	39.9	49.2	72.6	4MI-30X				11.8	14.3	15.3	16.7
4MJ-33X				28	44.5	55	81.4	4MJ-33X				13.2	15.9	17	18.9
4MK-35X				32.8	52	64.1	94.7	4MK-35X				15	18.3	19.7	21.9
6MI-40X				38.1	60.1	73.8	108.5	6MI-40X				18	21.7	23.4	26.1
6MJ-45X				42.7	67.5	83.3	123.5	6MJ-45X				20.2	24.5	26.4	29.2
6MK-50X				46.2	73.5	91	135	6MK-50X				22.2	27	29.2	32.8

Suction Gas Return 20°C, Subcooling 0K

* Suction Superheat 10K, Subcooling 0K

Preliminary data

Capacity Data

Condensing Temperature: 40°C															
R22	Cooling Capacity (kW)							R22	Power Input (kW)						
	Evaporating Temperature (°C)								Evaporating Temperature (°C)						
Models	-45	-35	-30	-20	-10	-5	+5	Models	-45	-35	-30	-20	-10	-5	+5
4MA-22X				22.1	34.5	42.2	61.2	4MA-22X				9.6	11.5	12.2	13.1
4MF-13X DC	4.2°	8.6°	11.5°	19.2°				4MF-13X DC	4.0°	6.4°	7.5°	9.7°			
4MH-25X				25.9	39.8	48.4	69.9	4MH-25X				11.6	13.7	14.5	15.7
4ML-15X DC	6.0°	11.7°	15.3°	23.7°				4ML-15X DC	5.9°	8.5°	9.8°	12.3°			
4MI-30X				28.3	42.9	51.9	74.3	4MI-30X				12.9	15.3	16.3	18
4MM-20X DC	7.0°	12.8°	16.6°	26.0°				4MM-20X DC	6.7°	9.3°	10.6°	13.2°			
4MJ-33X				31.8	48.1	58.2	83.3	4MJ-33X				14.4	17.1	18.3	20.1
4MT-22X DC	7.8°	14.4°	18.6°	29.2°				4MT-22X DC	7.5°	10.4°	11.9°	14.8°			
4MK-35X				36	54.5	66	94.4	4MK-35X				16.3	19.4	20.7	22.8
4MU-25X DC	8.9°	16.3°	21.0°	33.1°				4MU-25X DC	8.5°	11.8°	13.5°	16.8°			
6MI-40X				43.5	66.9	81.5	117.5	6MI-40X				19.8	23.3	24.7	26.7
6MJ-45X				47.4	73.4	89.5	129.5	6MJ-45X				22.1	26.5	28.3	31.2
6MK-50X				53.7	83.2	101.5	147	6MK-50X				25.1	30	32.1	35.4
6MM-30X DC	9.2°	17.7°	23.1°	35.8°				6MM-30X DC	9.4°	13.7°	15.7°	19.1°			
6MT-35X DC	10.3°	19.9°	25.9°	40.1°				6MT-35X DC	10.6°	15.3°	17.6°	21.4°			
6MU-40X DC	11.7°	22.5°	29.4°	45.5°				6MU-40X DC	12.0°	17.4°	20.0°	24.2°			

Suction Gas Return 20°C, Subcooling 0K

* Suction Superheat 10K, Subcooling 0K

° Additional Cooling Required

Preliminary data



Copeland™ Stream Digital with CoreSense™ Diagnostics for Continuous Capacity Modulation

Stream Digital series 4 and 6 cylinder compressors provide an alternative means of continuous modulation to inverter. Digital modulation is the most simple and precise method of capacity control and helps to contain applied costs associated with modulation.

Digital technology is based on controlling a high-cycle solenoid valve fitted on one of the cylinder heads based on cycle time. The valve actuates a piston that controls the flow of gas into the suction area of the Stream valve plate.

The compressor always runs at constant speed which resolves the challenges related to oil return, mechanical and electrical stress on the system.

All compressors are equipped with CoreSense technology and offer the possibility to diagnose system-related problems faster or even before they occur.



Copeland Stream Digital Compressor

Stream Digital Line-up

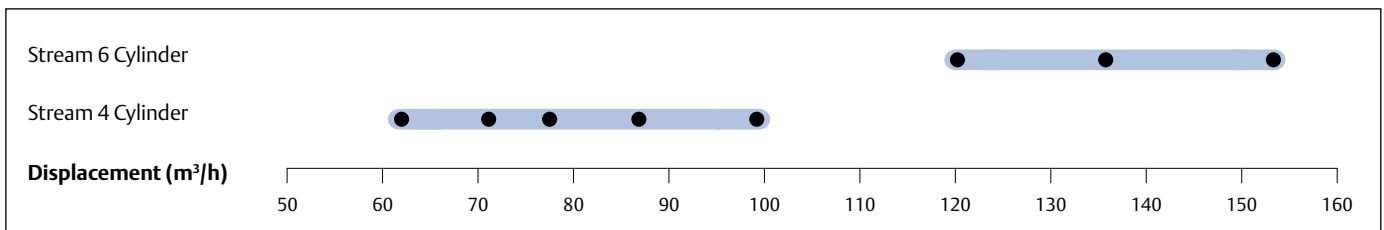

Features and Benefits

- Range of 16 Models from 62 to 153 m³/h
- Multi-refrigerant compressor as it is compatible with R404A, R407F, R407A/C, R134a and R22
- Continuous modulation from 50–100% (4-cylinder) and 33–100% (6-cylinder) ensuring a perfect match of capacity and power to refrigeration load
- Economical and reliable alternative to frequency inverters
- Precise suction pressure control with associated energy savings and stable evaporating temperatures
- Quick and easy integration into refrigeration equipment, similar to any other standard compressor
- Possibility to easily retrofit existing installations with digital cylinder head kit
- No vibrations or mechanical stress on system piping and compressor parts
- Reduced compressor cycling for longer contactor and compressor life
- Emerson CoreSense Diagnostics technology providing advanced protection, diagnostics and preventive maintenance

Operating Envelope R404A

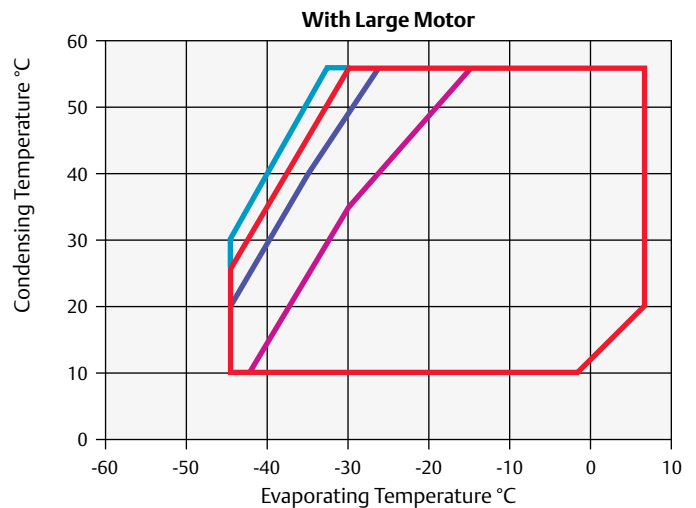
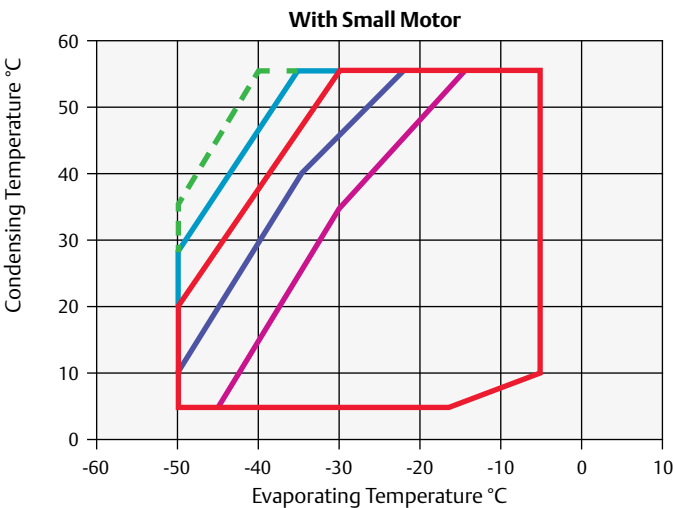

- 25°C SGRT at 100% modulation or 0°C SGRT + Fan between 33% (6 cyl) or 50% (4 cyl) and 99% modulation
- 0°C SGRT at 100% modulation
- - - SH > 20°C at 100% modulation
- 0°C SGRT between 33% (6 cyl) or 50% (4 cyl) and 99% modulation
- 25°C SGRT between 33% (6 cyl) or 50% (4 cyl) and 99% modulation

Operating Envelope R134a

With Small Motor

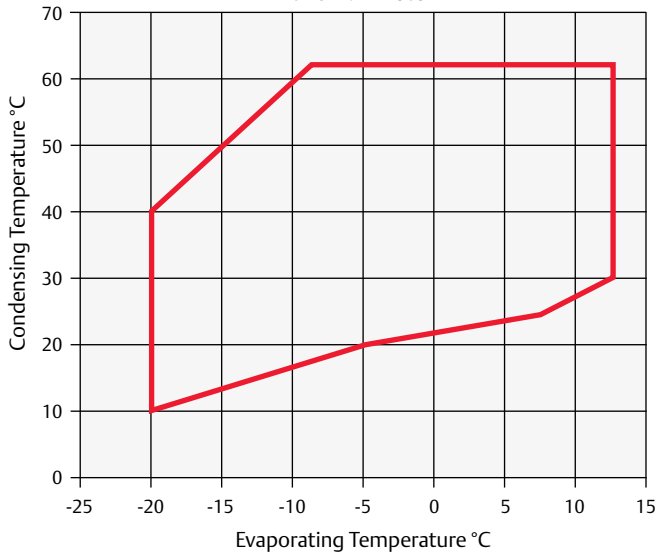

— 25°C Suction Gas Return

With Large Motor

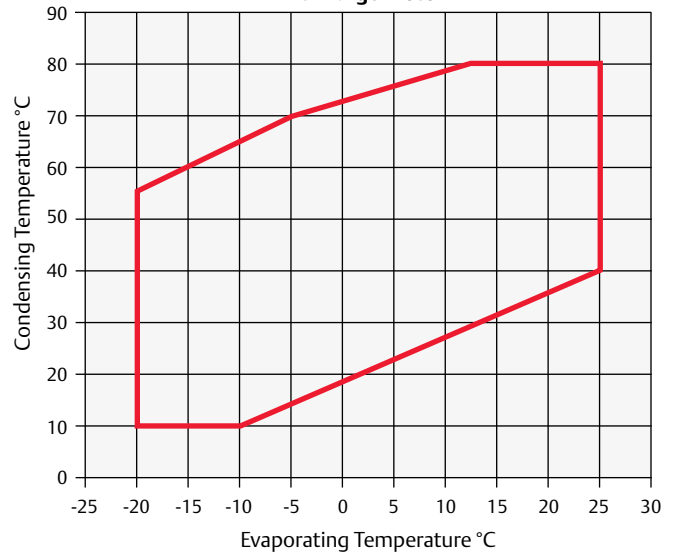

— 20K Suction Superheat

Operating Envelope R407C

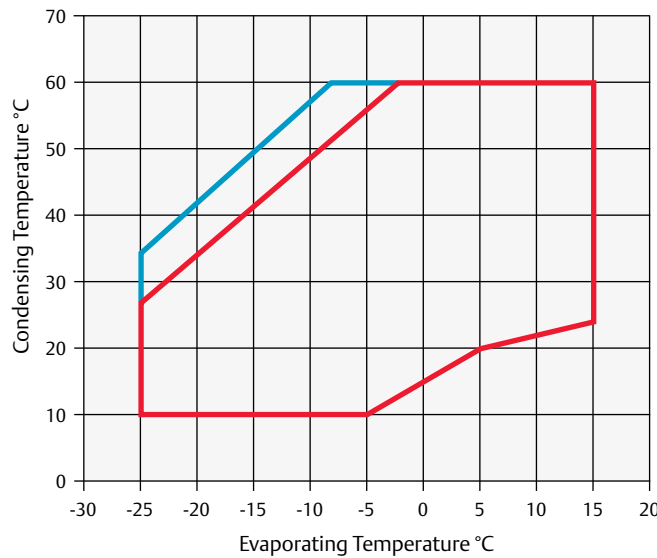

— 20°C Suction Gas Return — 0°C Suction Gas Return

For individual model details please refer to Select Software.

Operating Envelope R407F

With Small Motor

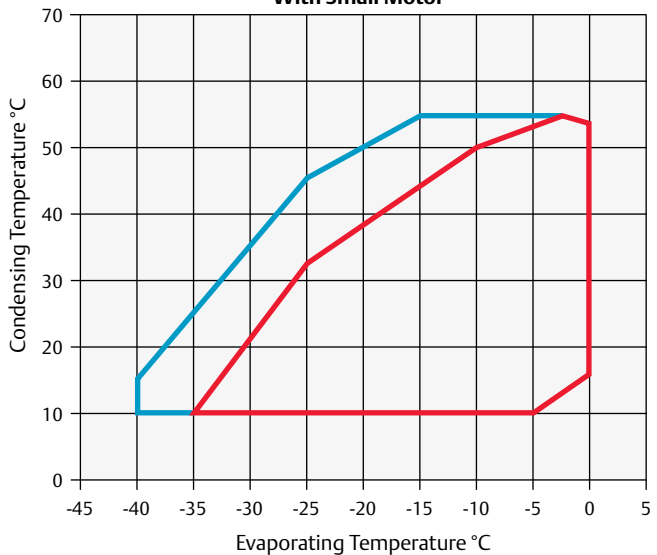

— 20°C Suction Gas Return — 0°C Suction Gas Return

With Large Motor

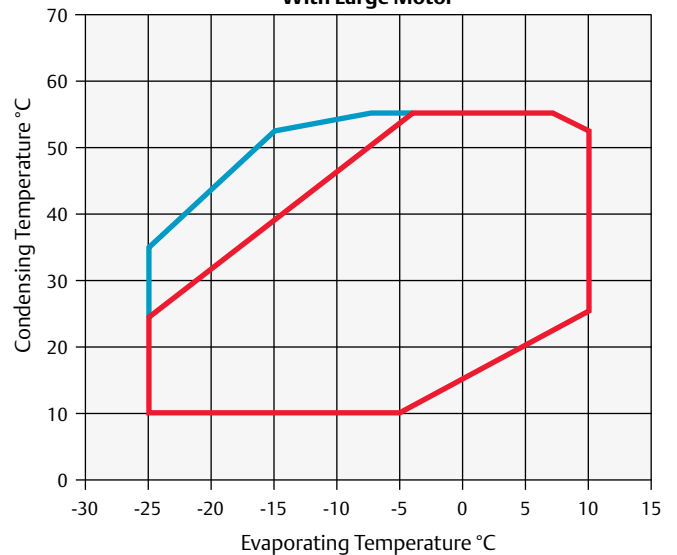

— 20°C Suction Gas Return — 0°C Suction Gas Return

Operating Envelope R407A

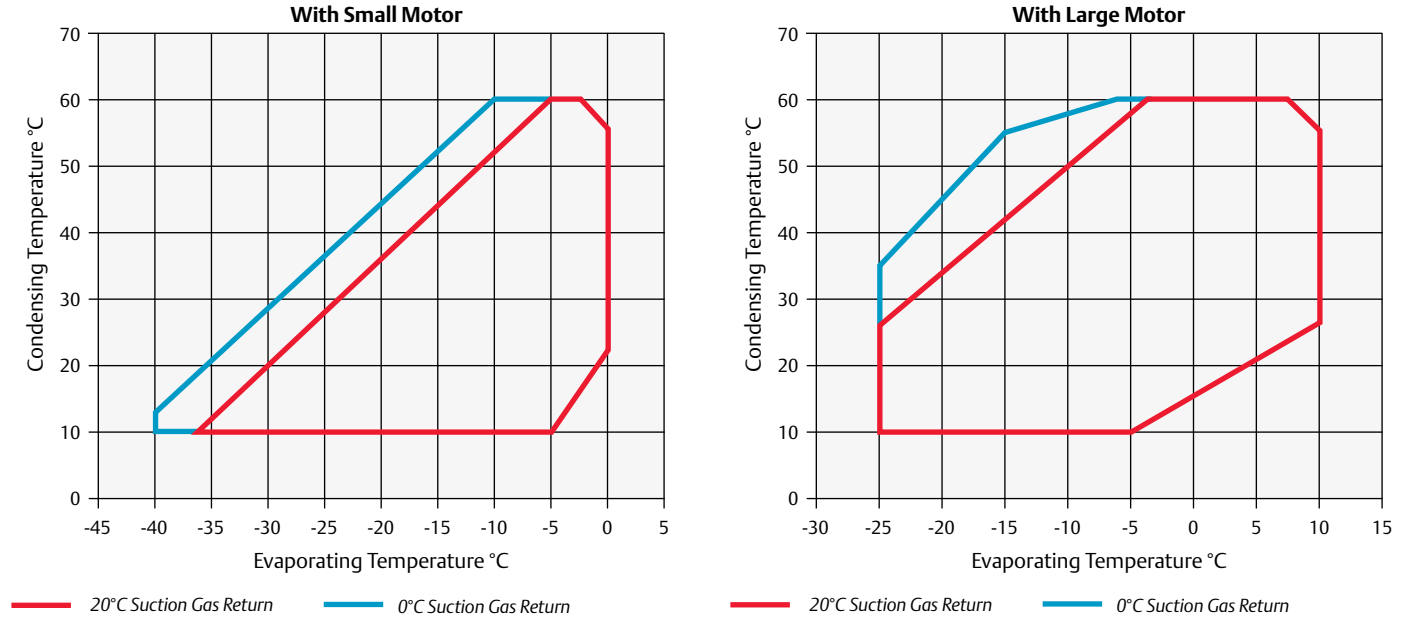

Technical Overview

Models	Nominal hp	Displacement (m ³ /h)	Oil Quantity (l)	Length/Width/Height (mm)	Net Weight (kg)	Motor Version/Code	Maximum Operating Current (A)	Locked Rotor Current (A)	Sound Pressure @ 1 m (dBA) ***
						3 Ph**	3 Ph**	3 Ph**	
4MFD-13X	13	61.7	3.3	638/501/452	183	AWM	30.8	105	70
4MAD-22X	22	61.7	3.3	638/501/452	183	AWM	36.3	175	75
4MLD-15X	15	71.4	3.3	638/501/452	186	AWM	35.4	156	71
4MHD-25X	25	71.4	3.3	657/501/452	193	AWM	41.6	199	75
4MMD-20X	17	78.2	3.3	657/501/452	188	AWM	39	175	71
4MID-30X	27	78.2	3.3	657/501/452	194	AWM	46.6	221	75
4MTD-22X	22	87.7	3.3	657/501/452	189	AWM	44.5	175	73
4MJD-33X	33	87.7	3.3	657/501/452	196	AWM	52.9	221	74
4MUD-25X	25	99.4	3.3	657/501/452	192	AWM	51.9	199	72
4MKD-35X	32	99.4	3.3	688/501/452	202	AWM	61.1	255	74
6MMD-30X	27	120.5	3.3	695/547/450	221	AWM	59.7	255	78
6MID-40X	35	120.5	3.3	695/547/450	225	AWM	71.4	304	78
6MTD-35X	32	135	3.3	725/547/450	227	AWM	67.3	255	77
6MJD-45X	40	135	3.3	725/547/450	229	AWM	81.5	304	79
6MUD-40X	40	153	3.3	757/547/450	231	AWM	75.8	304	78
6MKD-50X	50	153	3.3	773/547/450	236	AWM	92.9	393	80

** 3 Ph: 380-420V/ 50Hz

*** @ 1m: sound pressure level at 1m distance from the compressor, free field condition

Capacity Data

Condensing Temperature: 40°C															
R134a	Cooling Capacity (kW)							R134a	Power Input (kW)						
	Evaporating Temperature (°C)								Evaporating Temperature (°C)						
	Models	-45	-35	-30	-20	-10	-5		+5	Models	-45	-35	-30	-20	-10
4MAD-22X		4.0*	6.2*	11.8*	20.0*	25.4*	39.7	4MAD-22X		3.7*	4.4*	5.9*	7.3*	7.9*	8.7
4MFD-13X				12.1	20.2	25.4	38.5	4MFD-13X				5.8	7.2	7.8	8.7
4MHD-25X		4.4*	6.9*	13.5*	23.1*	29.3*	45.9	4MHD-25X		4.7*	5.4*	7.1*	8.7*	9.4*	10.4
4MLD-15X				14.8	24.2	30.2	45.5	4MLD-15X				6.9	8.5	9.3	10.4
4MID-30X		5.2*	8.0*	15.1*	25.4*	32.2*	50.2	4MID-30X		4.9*	5.8*	7.6*	9.4*	10.3*	11.4
4MMD-20X				16.5	26.7	33.3	49.8	4MMD-20X				7.7	9.4	10.2	11.4
4MJD-33X		6.0*	9.1*	17.0*	28.5*	35.9*	55.9	4MJD-33X		5.6*	6.6*	8.7*	10.7*	11.5*	12.8
4MTD-22X				18.9	30.3	37.7	56.7	4MTD-22X				8.7	10.8	11.7	13.1
4MKD-35X		7.0*	10.4*	19.1*	31.9*	40.3*	62.7	4MKD-35X		7.1*	7.7*	9.7*	12.2*	13.3*	14.9
4MUD-25X				20.5	33.5	41.9	63.2	4MUD-25X				9.8	12.2	13.3	15.1
6MID-40X				22.2*	37.6*	47.8*	75.3	6MID-40X				12.0*	14.6*	15.8*	17.8
6MMD-30X				24.9	40.3	50.2	75.3	6MMD-30X				11.7	14.6	15.8	17.7
6MJD-45X				25.6*	42.7*	54.0*	84.5	6MJD-45X				13.0*	16.2*	17.8*	20.3
6MTD-35X				28.2	45.5	56.5	84.4	6MTD-35X				13.3	16.5	17.9	20.0
6MKD-50X				26.2*	45.7*	58.6*	93.4	6MKD-50X				15.2*	18.8*	20.5*	23.3
6MUD-40X				31.2	50.1	62.3	93.6	6MUD-40X				14.6	18.4	20.1	23.0

Suction Gas Return 20°C, Subcooling 0K, 100% loaded

* Suction Superheat 10K, Subcooling 0K

Condensing Temperature: 40°C															
R407A	Cooling Capacity (kW)							R407A	Power Input (kW)						
	Evaporating Temperature (°C)								Evaporating Temperature (°C)						
	Models	-45	-35	-30	-20	-10	-5		+5	Models	-45	-35	-30	-20	-10
4MFD-13X				18.3*	30.9	37.9		4MFD-13X				9.7*	11.8	12.7	
4MAD-22X					32.2	39.9	59.3	4MAD-22X					11.7	12.6	14.0
4MLD-15X				22.7*	37.7	46.1		4MLD-15X				11.4*	13.8	14.9	
4MHD-25X					37.4	46.2	68.5	4MHD-25X					13.7	14.6	15.9
4MMD-20X				24.9*	41.2	50.5		4MMD-20X				12.7*	15.3	16.5	
4MID-30X				21.6*	37.4	46.2	68.5	4MID-30X				11.4*	13.7	14.6	15.9
4MTD-22X				26.5*	44.2	54.2		4MTD-22X				14.5*	17.5	18.9	
4MJD-33X					41.7	51.4	75.7	4MJD-33X					15.1	16.1	17.8
4MUD-25X				30.1*	50.4	61.8		4MUD-25X				16.2*	19.9	21.6	
4MKD-35X					52.1	64.1	94.2	4MKD-35X					19.5	20.9	23.4
6MMD-30X			20.9*	39.3	61.3	75.0		6MMD-30X			14.9*	19.4	23.6	25.5	
6MID-40X				40.4	63.6	78.3	115.5	6MID-40X				19.3	23.3	25.0	27.6
6MTD-35X			24.8*	45.3	70.3	86.0		6MTD-35X			16.8*	21.9	26.9	29.1	
6MJD-45X				45.0	70.7	87.0	128.0	6MJD-45X				21.5	26.1	28.0	31.0
6MUD-40X				50.4	78.7	96.7		6MUD-40X				24.4	30.1	32.8	
6MKD-50X				50.1	78.6	96.6	142.0	6MKD-50X				24.4	29.8	32.3	36.4

Suction Gas Return 20°C, Subcooling 0K, 100% loaded

* Suction Superheat 10K, Subcooling 0K

Capacity Data

Condensing Temperature: 40°C															
R407F	Cooling Capacity (kW)							R407F	Power Input (kW)						
	Evaporating Temperature (°C)								Evaporating Temperature (°C)						
Models	-45	-35	-30	-20	-10	-5	+5	Models	-45	-35	-30	-20	-10	-5	+5
4MAD-22X				20.5*	34.4	42.6	63.1	4MAD-22X				10.2*	12.4	13.2	14.4
4MFD-13X				19.5*	32.2	39.5		4MFD-13X				10.2*	12.4	13.3	
4MHD-25X				23.9*	40.0	49.4	73.1	4MHD-25X				11.9*	14.4	15.4	16.8
4MLD-15X				23.9*	39.4	48.4		4MLD-15X				12.0*	14.6	15.7	
4MID-30X				26.6*	44.0	54.2	79.9	4MID-30X				13.1*	15.8	17.0	18.6
4MMD-20X				26.3*	43.0	52.9		4MMD-20X				13.3*	16.0	17.2	
4MJD-33X				29.8*	49.0	60.3	88.9	4MJD-33X				14.8*	17.8	19.2	21.1
4MTD-22X				29.5*	48.0	58.9		4MTD-22X				15.1*	18.3	19.7	
4MKD-35X				33.3*	54.8	67.6	100.0	4MKD-35X				16.8*	20.4	22.0	24.4
4MUD-25X				32.9*	54.0	66.3		4MUD-25X				17.1*	21.0	22.8	
6MID-40X				40.7*	67.2	82.6	121.5	6MID-40X				20.2*	24.4	26.2	28.9
6MMD-30X				40.2*	65.4	79.9		6MMD-30X				20.4*	24.8	26.7	
6MJD-45X				45.3*	74.5	91.6	135.0	6MJD-45X				22.9*	27.6	29.7	32.8
6MTD-35X				45.3*	73.3	89.5		6MTD-35X				23.1*	28.0	30.3	
6MKD-50X				50.7*	83.7	103.0	151.5	6MKD-50X				25.8*	31.3	33.7	37.5
6MUD-40X				47.9*	81.9	100.5		6MUD-40X				25.9*	31.7	34.4	
4MFD-13X DC				20.2	32.4	40.1		4MFD-13X DC				10.2	12.4	13.3	
4MLD-15X DC				24.8	39.7	48.9		4MLD-15X DC				12.0	14.6	15.6	
4MMD-20X DC				27.2	43.5	53.8		4MMD-20X DC				13.3	16.0	17.2	
4MTD-22X DC				30.5	48.5	59.8		4MTD-22X DC				15.1	18.3	19.7	
4MUD-25X DC				34.1	54.5	67.3		4MUD-25X DC				17.2	21.0	22.8	
4MMD-30X DC				41.6	65.9	81.2		4MMD-30X DC				20.4	24.8	26.7	
6MTD-35X DC				47.2	73.8	90.3		6MTD-35X DC				23.1	28.0	30.3	
6MUD-40X DC				50.6	81.9	101.6		6MUD-40X DC				25.9	31.7	34.4	

Suction Gas Return 20°C, Subcooling 0K, 100% loaded

* Suction Superheat 10K, Subcooling 0K

Preliminary data

Capacity Data

Condensing Temperature: 40°C															
R404A	Cooling Capacity (kW)							R404A	Power Input (kW)						
	Evaporating Temperature (°C)								Evaporating Temperature (°C)						
Models	-45	-35	-30	-20	-10	-5	+5	Models	-45	-35	-30	-20	-10	-5	+5
4MAD-22X		8.1*	11.7*	23.4	35.6	43.1	61.3	4MAD-22X		7.3*	8.6*	11.0	13.0	13.7	14.7
4MFD-13X		8.3*	11.5*	22.6	34.5	41.8		4MFD-13X		7.4*	8.7*	11.0	13.1	13.9	
4MHD-25X		9.6*	13.7*	27.2	41.7	50.7	72.9	4MHD-25X		8.6*	10.1*	13.0	15.4	16.3	17.5
4MLD-15X		10.6*	14.5*	27.6	41.6	50.2		4MLD-15X		9.0*	10.5*	13.3	15.8	16.7	
4MID-30X		11.4*	16.2*	30.9	46.3	55.7	78.7	4MID-30X		9.8*	11.5*	14.5	17.0	18.0	19.5
4MMD-20X		12.2*	16.4*	30.6	45.6	54.8		4MMD-20X		10.1*	11.6*	14.6	17.1	18.2	
4MJD-33X		12.9*	17.8*	34.2	51.9	62.7	89.5	4MJD-33X		10.9*	12.6*	16.1	19.0	20.2	21.8
4MTD-22X		13.7*	18.4*	34.3	51.5	62.1		4MTD-22X		11.5*	13.2*	16.6	19.5	20.7	
4MKD-35X		14.5*	20.0*	38.4	58.3	70.6	101.0	4MKD-35X		12.6*	14.6*	18.5	22.0	23.5	25.7
4MUD-25X		14.9*	20.1*	38.1	57.5	69.5		4MUD-25X		12.9*	14.9*	18.8	22.3	23.7	
6MID-40X		17.3*	28.6°	46.2	70.1	84.9	121.5	6MID-40X		15.2*	17.6°	22.2	26.1	27.7	30.1
6MMD-30X		18.2*	29.0°	46.0	69.5	84.3		6MMD-30X		15.7*	18.1°	22.5	26.3	27.8	
6MJD-45X		19.2*	32.0°	51.9	78.7	95.1	135.0	6MJD-45X		16.8*	19.6°	24.9	29.5	31.4	33.9
6MTD-35X		20.5*	32.7°	52.0	78.5	94.9		6MTD-35X		17.5*	20.1°	25.3	29.7	31.5	
6MKD-50X		21.4*	36.0°	58.1	87.7	106.0	150.5	6MKD-50X		19.4*	22.5°	28.3	33.5	35.9	39.9
6MUD-40X		22.6*	36.5°	58.1	88.1	107.0		6MUD-40X		19.7*	22.7°	28.5	33.6	35.8	

Suction Gas Return 20°C, Subcooling 0K, 100% loaded

* Suction Superheat 10K, Subcooling 0K

° Additional Cooling Required

Condensing Temperature: 40°C															
R407C	Cooling Capacity (kW)							R407C	Power Input (kW)						
	Evaporating Temperature (°C)								Evaporating Temperature (°C)						
Models	-45	-35	-30	-20	-10	-5	+5	Models	-45	-35	-30	-20	-10	-5	+5
4MAD-22X				18.1*	30.4	37.4	55.0	4MAD-22X				9.2*	11.2	12.0	12.9
4MHD-25X				20.9*	35.3	43.7	64.6	4MHD-25X				10.7*	12.9	13.8	15.1
4MID-30X				23.7*	39.5	48.7	71.9	4MID-30X				11.8*	14.3	15.3	16.7
4MJD-33X				26.3*	44.1	54.4	80.6	4MJD-33X				13.2*	15.9	17.1	18.9
4MKD-35X				31.0*	51.4	63.5	93.8	4MKD-35X				15.1*	18.3	19.7	21.9
6MID-40X				35.7*	59.5	73.1	107.0	6MID-40X				18.0*	21.7	23.4	26.1
6MJD-45X				40.0*	66.8	82.5	122.5	6MJD-45X				20.2*	24.5	26.4	29.2
6MKD-50X				43.0*	72.8	90.0	134.0	6MKD-50X				22.2*	27.0	29.2	32.8

Suction Gas Return 20°C, Subcooling 0K, 100% loaded

* Suction Superheat 10K, Subcooling 0K

Condensing Temperature: 40°C															
R22	Cooling Capacity (kW)							R22	Power Input (kW)						
	Evaporating Temperature (°C)								Evaporating Temperature (°C)						
Models	-45	-35	-30	-20	-10	-5	+5	Models	-45	-35	-30	-20	-10	-5	+5
4MAD-22X				21.4*	34.1	41.7	60.6	4MAD-22X				9.6*	11.5	12.2	13.1
4MHD-25X				25.2*	39.4	48.0	69.2	4MHD-25X				11.6*	13.7	14.5	15.7
4MID-30X				27.5*	42.4	51.4	73.6	4MID-30X				12.9*	15.3	16.3	18.0
4MJD-33X				30.8*	47.6	57.6	82.5	4MJD-33X				14.4*	17.1	18.3	20.1
4MKD-35X				35.0*	53.9	65.3	93.5	4MKD-35X				16.3*	19.4	20.7	22.8
6MID-40X				42.2*	66.2	80.6	116.5	6MID-40X				19.8*	23.3	24.7	26.7
6MJD-45X				45.7*	72.6	88.6	128.5	6MJD-45X				22.1*	26.5	28.3	31.2
6MKD-50X				51.9*	82.4	100.5	145.5	6MKD-50X				25.1*	30.0	32.1	35.4

Suction Gas Return 20°C, Subcooling 0K, 100% loaded

* Suction Superheat 10K, Subcooling 0K

Copeland™ Stream Compressors with CoreSense™ Diagnostics for R744-Transcritical Applications

Stream series of 4 cylinder CO₂ compressors is the ideal solution for R744 medium temperature cascade and booster systems. It is characterized by a design pressure of 135 bar. Refrigerant flow and heat transfer have been optimized for best performance. All compressors are equipped with CoreSense technology and offer the possibility to diagnose system-related problems faster or even before they occur.



*Copeland Stream Compressors for R744 Refrigeration
Designed for Durability and Best-in-Class
Performance in R744-Transcritical Applications*

Stream Compressor Line-up

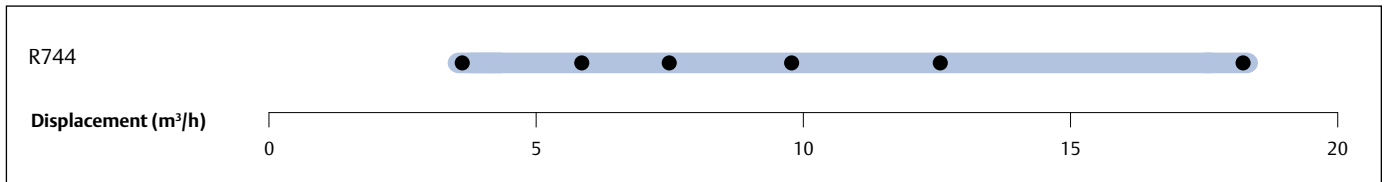

Conditions: EN12900 R744: Evaporating -10°C, Gas cooler exit: 35°C/ 90 bar, Superheat: 10K

Features and Benefits

Stream provides for flexibility in pack design and operation:

- Compact dimensions
- Integrated high and low pressure relief valve
- Discharge Temperature Protection
- Service valve 360° rotation for ease of piping design
- 2 sight glasses for mounting of oil management control and visual inspection
- One additional sight glass for oil visual inspection at run time
- One oil port for oil equalization in parallel system
- Oil splasher system ensuring lubrication at constant and variable speed

Designed for durability and performance in R744 applications:

- Low sound, low vibration and large discharge chamber to eliminate pulsation
- High design pressures of 135 bar (high side) and 90 bar (low side)
- Burst pressures in excess of safety factor 3
- Cylinder head and discharge plenum design minimizing heat transfer to suction side
- Stepless capacity modulation via inverter from 25 to 70Hz
- CoreSense™ Diagnostics
- Individual compressor power consumption monitoring

Operating Envelope R744

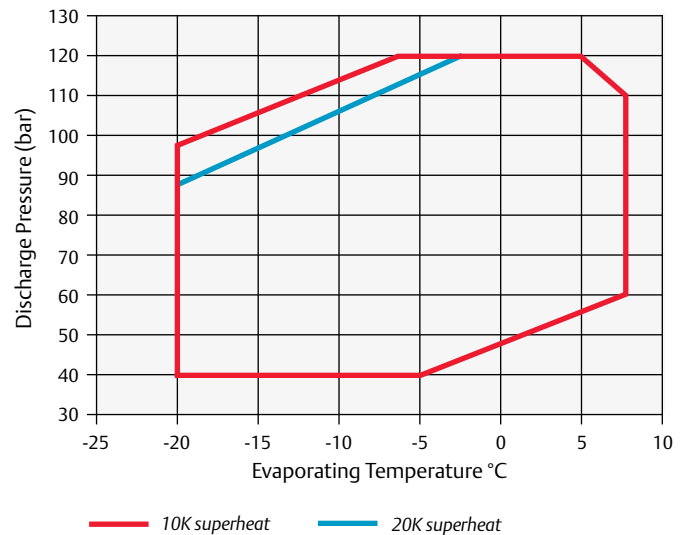

Technical Overview

Models	Nominal hp	Displacement (m ³ /h)	Capacity (kw)	COP	Oil Quantity (l)	Length/Width/Height (mm)	Net Weight (kg)	Motor Version/ Code	Maximum Operating Current (A)	Locked Rotor Current (A)				Sound Pressure @ 1 m (dBA)***
										3 Ph**	3 Ph**	EWL Delta min	EWL Delta max	
4MTL-05X	5.0	4.6	9.3	1.6	1.7	630/425/410	140	EWL	13.3	127.0	138.5	72.8	80.5	
4MTL-07X	6.5	6.2	12.5	1.6	1.7	630/425/410	140	EWL	17.5	128.3	140.0	73.6	81.3	
4MTL-09X	9.0	7.4	15.3	1.6	1.7	630/425/410	140	EWL	20.8	147.5	160.9	84.6	93.5	
4MTL-12X	12.0	9.5	19.2	1.7	1.7	697/445/422	170	AWM	26	145				67
4MTL-15X	15.0	12.5	25.2	1.8	1.7	697/445/422	170	AWM	35	156				71
4MTL-30X	30.0	17.9	37.0	1.8	1.7	697/445/422	175	AWM	50	221				75

Conditions: EN12900 R744: Evaporating -10°C, Gas cooler exit:35°C/90bar, Superheat: 10K

10K Border

** 3 Ph: 380-420V/ 50Hz

*** @ 1m: sound pressure level at 1m distance from the compressor, free field condition

Preliminary data

Capacity Data

R744	Gas Cooler/ Condensing	Temperature (°C)	Pressure (bar)	Cooling Capacity (kW)					Power Input (kW)				
				Evaporating Temperature (°C)					Evaporating Temperature (°C)				
				-20	-15	-10	-5	0	-20	-15	-10	-5	0
				Equivalent evaporation pressure (bar)					Equivalent evaporation pressure (bar)				
				19.7	22.9	26.5	30.5	34.9	19.7	22.9	26.5	30.5	34.9
4MTL-12X	Condensing	10.0		24.1	29.1	35.0	41.7		6.1	5.9	5.5	4.9	
		15.0		21.8	26.4	31.9	38.1	45.0	6.8	6.8	6.5	6.0	5.3
		20.0		19.5	23.7	28.6	34.3	40.6	7.6	7.6	7.4	7.1	6.5
		25.0		16.9	20.6	25.0	30.0	35.6	8.3	8.5	8.4	8.2	7.7
		30.0		13.5	16.5	20.0	24.1	28.6	9.0	9.3	9.4	9.3	9.0
	Gas Cooler	35.0	90.0	12.8	15.7	19.3	23.3	27.9	10.2	10.9	11.3	11.6	11.6
		40.0	100.0		13.6	16.8	20.4	24.4		11.5	12.2	12.6	12.8
		40.0	110.0			17.4	21.2	25.5			12.8	13.5	13.9
4MTL-15X	Condensing	10.0		31.2	37.9	45.6	54.4		7.9	7.6	7.1	6.3	
		15.0		28.3	34.5	41.6	49.7	58.7	8.8	8.7	8.4	7.8	6.9
		20.0		25.3	30.9	37.4	44.8	53.0	9.7	9.7	9.6	9.2	8.6
		25.0		22.0	26.9	32.7	39.3	46.6	10.5	10.8	10.8	10.7	10.2
		30.0		17.5	21.5	26.2	31.6	37.5	11.4	11.8	12.0	12.1	11.8
	Gas Cooler	35.0	90.0	16.5	20.5	25.2	30.5	36.5	13.1	13.8	14.4	14.8	15.0
		40.0	100.0		17.7	21.8	26.6	31.8		14.8	15.5	16.1	16.5
		40.0	110.0			22.5	27.5	33.1			16.6	17.3	17.9
4MTL-30X	Condensing	10.0		45.6	54.9	65.9	78.3		11.4	11.0	10.4	9.3	
		15.0		41.5	50.2	60.3	71.7	84.4	12.6	12.5	12.1	11.4	10.2
		20.0		37.2	45.1	54.3	64.7	76.3	13.9	14.0	13.9	13.4	12.5
		25.0		32.4	39.4	47.6	56.9	67.2	15.2	15.5	15.6	15.4	14.8
		30.0		25.9	31.6	38.3	45.8	54.2	16.4	17.0	17.3	17.4	17.1
	Gas Cooler	35.0	90.0	24.7	30.3	37.0	44.6	53.1	18.8	19.8	20.6	21.2	21.5
		40.0	100.0		26.3	32.2	39.0	46.5		21.2	22.2	23.0	23.6
		40.0	110.0			33.4	40.5	48.5			23.8	24.8	25.6

Suction Superheat 10K, Subcooling 0K

Copeland™ Stream Compressors with CoreSense™ Diagnostics for R744-Subcritical Applications Requiring High Standstill Pressures (90Bar)

Stream series of 4 cylinder CO₂ compressors is the ideal solution for R744 low temperature cascade and booster systems requiring high standstill pressure of up to 90 bar Suction. The use of transcritical compressors in medium / transcritical side as well as on the low temperature / subcritical side ensures that in case of power outage, the refrigeration system features full resilience and no operation disruption.

Stream is characterized by a design pressure of 135 bar. Refrigerant flow and heat transfer have been optimized for best performance. All compressors are equipped with CoreSense technology and offer the possibility to diagnose system-related problems faster or even before they occur.



Copeland Stream Compressors for Low Temperature Applications with R744 Designed for Durability and Best-in-class Performance in R744 Subcritical Applications

Stream Compressor Line-up

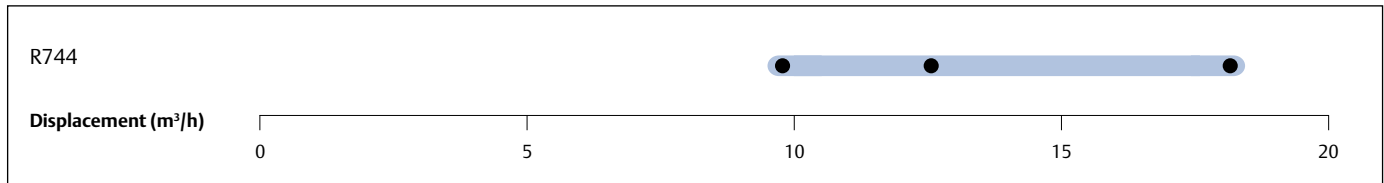

Conditions: EN12900 R744: Evaporating -10°C, Gas cooler exit: 35°C/ 90 bar, Superheat: 10K

Features and Benefits

Stream provides for flexibility in pack design and operation:

- Compressor Max. Pressures (Suction/Discharge): 90 bar / 135 bar
- Compact dimensions
- Integrated high and low pressure relief valve
- Discharge Temperature Protection
- Service valve 360° rotation for ease of piping design
- 2 sight glasses for mounting of oil management control and visual inspection
- One additional sight glass for oil visual inspection at run time
- One oil port for oil equalization in parallel system
- Oil splasher system ensuring lubrication at constant and variable speed

Designed for durability and performance in R744 applications:

- Low sound, low vibration and large discharge chamber to eliminate pulsation
- Optimized motor selection for low temperature running conditions
- Burst pressures in excess of safety factor 3
- Cylinder head and discharge plenum design minimizing heat transfer to suction side
- Stepless capacity modulation via inverter from 25 to 70Hz
- CoreSense Diagnostics for advanced protection, diagnostics, communication
- Individual compressor power consumption monitoring

Operating Envelope R744

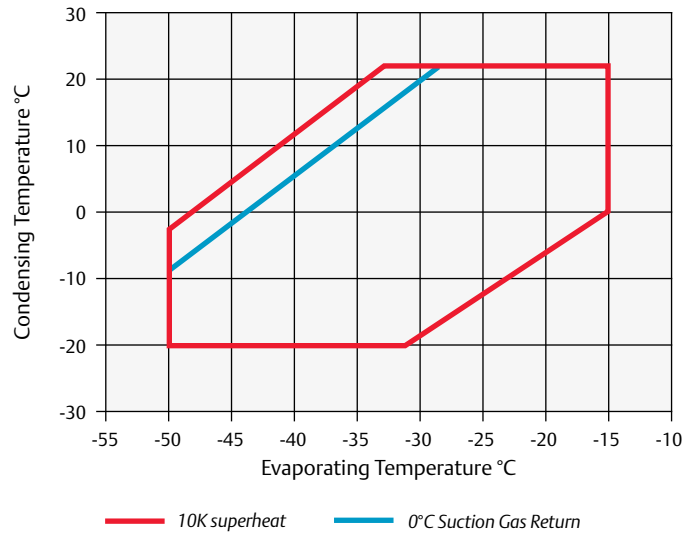

Technical Overview

Models	Nominal hp	Displacement (m ³ /h)	Capacity (kw)	COP	Oil Quantity (l)	Length/Width/Height (mm)	Net Weight (kg)	Motor Version/ Code	Locked Rotor Current (A)
								3 Ph**	3 Ph**
4MSL-10X	5.0	9.5	9.5	3.4	1.8	697/445/422	170	AWM	101
4MSL-12X	7.0	12.5	12.5	3.7	1.8	697/445/422	170	AWM	145
4MSL-15X	9.0	18.0	17.9	3.8	1.8	697/445/422	170	AWM	170

EN12900 R744 - LT: Evaporating -35°C, Condensing -5°C, Suction Superheat 10K, Subcooling 0K

** 3 Ph: 380-420V/ 50Hz

Preliminary data

Capacity Data

Condensing Temperature: -10°C									
R744	Cooling Capacity (kW)				R744	Power Input (kW)			
	Evaporating Temperature (°C)					Evaporating Temperature (°C)			
Models	-45	-40	-35	-30	Models	-45	-40	-35	-30
4MSL-08X	10.3	17.2	21.5		4MSL-08X	3.8	3.9	3.7	
4MSL-12X	13.8	22.7	28.4		4MSL-12X	4.9	5.0	4.8	
4MSL-15X	20.3	33.4	41.5		4MSL-15X	7.0	7.2	7.0	

Suction Superheat 10K, Subcooling 0K

S-Series Reciprocating Compressor Range

This compressor series is superseded by the Stream and Discus reciprocating compressors offering a wide choice of equivalent products at higher efficiency. Product descriptions and performance data can be found on pages 68 to 89.

For replacement needs, please refer to the cross-reference table below guiding you in the product selection. More detailed information is available with our “Guidelines for replacement of S-Series compressors” available from Emerson Climate sales office or as download under www.emersonclimate.eu



S-Series Compressor

S-Series Replacements

D4SF-100X	→	4MFS1-13X
D4SA-100X	→	4MFS1-13X
D4SA-200X	→	4MAS1-22X
D4SL-150X	→	4MLS1-15X
D4SH-150X	→	4MLS1-15X
D4SH-250X	→	4MHS1-25X
D4ST-200X	→	4MMS1-20X
D4SJ-200X	→	4MMS1-20X
D4SJ-300X	→	4MIS1-30X
D6SF-200X	→	4MLS1-15X
D6SA-300X	→	4MIS1-30X
D6SL-250X	→	6MLS1-27X
D6SH-200X	→	6MLS1-27X
D6SH-350X	→	6MHS1-35X
D6ST-320X	→	6MMS1-30X
D6SJ-300X	→	6MMS1-30X
D6SJ-400X	→	6MIS1-40X
D6SU-400X	→	6MTS1-35X
D6SK-400X	→	6MTS1-35X
D6SK-500X	→	6MJS1-45X

Service Compressors for 4 and 6 cylinder S-Series and Discus Reciprocating Compressors

With the successful launch of Stream with CoreSense™ Diagnostics 4M and 6M compressors, Emerson has decided to consolidate product families to allow our customers to reduce product proliferation and cost of operation. As a result, Emerson will in the future only produce the most efficient semi-hermetic reciprocating compressor platforms out of its current portfolio.

With a large number of 4 and 6 cylinder S-Series and Discus compressors operating in applications around the world, Emerson Climate Technologies recognizes the importance of providing worry-free drop-in replacement models. The range of service compressors offers easy replacement (“like for like”) without the need of system adaptations.

More detailed information is available with our “Guidelines for replacement of S-Series and Discus compressors” available from your Emerson Climate sales office or as download under www.emersonclimate.eu

For your product selection in case of replacement needs, please refer to the cross-reference table below. In addition, our local Application Engineering and Sales team is ready to support you.



*Service Compressor**

Discus Replacements

D4DF-100X	→	4MFS1-13X
D4DA-100X	→	4MFS1-13X
D4DA-200X	→	4MAS1-22X
D4DL-150X	→	4MLS1-15X
D4DH-150X	→	4MLS1-15X
D4DH-250X	→	4MHS1-25X
D4DT-220X	→	4MMS1-20X
D4DJ-200X	→	4MMS1-20X
D4DJ-300X	→	4MIS1-30X
D6DL-270X	→	6MLS1-27X
D6DH-200X	→	6MLS1-27X
D6DH-350X	→	6MHS1-35X
D6DT-320X	→	6MMS1-30X
D6DJ-300X	→	6MMS1-30X
D6DJ-400X	→	6MIS1-40X

*Valves are available as optional accessories.



Condensing Units

Emerson Climate Technologies offers the broadest and most reliable condensing unit product line-up. Leveraging the latest compressor technology, each platform provides you the option to select the refrigerant, capacity and application temperature combinations that meet your requirements. A huge variety of Copeland™ indoor and outdoor condensing units offer the right solution for applications in food retail and food service, commercial and industrial refrigeration.

Copeland EazyCool™ Scroll Outdoor Condensing Units are designed and fully equipped for a quick and easy installation and ideal to integrate into urban environments. The latest scroll technology is combined with high-quality Alco components and covered by a weatherproof housing in a unique design.

The Copeland EazyCool Outdoor Condensing Unit ZX Series offers the highest energy efficiency available in a standard unit to lower operators' utility bills. Ranging in size from 2 to 7.5 hp, the ZX units are perfectly suited for typical food service and retail applications. The key benefits of compactness, silence and efficiency in the standard models will be enhanced by the capability of continuous capacity modulation of the ZX Digital models. This makes ZX Digital condensing units the perfect fit for applications with wide load variations.

Copeland Scroll™ indoor condensing units are equipped with the latest refrigeration scroll compressors and constitute the widest range of their kind. The modular line concept offers base units which can be adapted to the target application by various options including weather housings and fan speed controls.

Copeland Scroll™ Digital Receiver Units HLR are an innovative offering for food service and retail businesses. Their compact design and the power of Digital Scroll continuous capacity modulation enable optimized environmental integration with highest system efficiency.

Semi-hermetic condensing units: robust, reliable and efficient air-cooled condensing unit platforms featuring semi-hermetic reciprocating compressor technology are for use in high-, medium- and low-temperature applications. Emerson Climate Technologies has expanded its semi-hermetic product range by the innovative Stream Indoor Condensing Units. Therewith we can offer a product range from 0,8 - 40 hp with dedicated refrigerant approvals for R404A, R407A/C/F and R134a.

Aligned to our brand and color change for Emerson's semi-hermetic compressor ranges we also harmonized the condensing units that are featuring semi-hermetic compressors. From now on we will only use the well-known 'Copeland™ brand products' label replacing 'DWM Copeland' and change the unit and compressor color from grey to black. With this initiative all compressors and indoor condensing units from Emerson - with Scroll or piston technology - will be using one branding and color: Copeland™ brand products, painted in black.

Copeland EazyCool™ Outdoor Condensing Units with Scroll Compressors

Copeland™ air-cooled outdoor condensing units for medium-temperature and low-temperature applications.

Emerson Climate Technologies has developed this series of condensing units especially for outdoor use. The latest Scroll technology is combined with high-quality components and covered by an absolutely weather-resistant synthetic resin housing in a unique design.

The EazyCool line-up offers state-of-the-art technology and models featuring stepless capacity control, vapor injection and fan speed control. This makes it the first choice for target applications in food retail and food service:

- Proximity and convenience stores
- Mini markets and supermarkets
- Bars, restaurants and kitchens
- Beer cellars and beverage coolers



Copeland EazyCool Outdoor Condensing Units with Scroll Compressors

EazyCool OLQ/OMQ Line-up

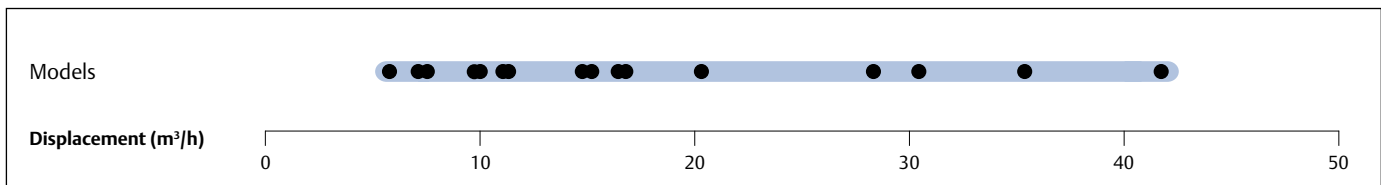

EazyCool Digital Line-up

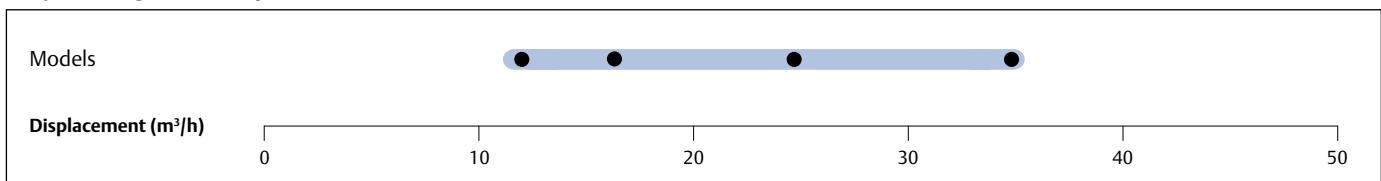

Features and Benefits

- Standard equipment: Scroll compressor(s), crankcase heater(s), condenser with thermally protected fan(s), fan speed control, HP and LP switch, liquid receiver, filter drier & sight glass, weather-resistant housing
- Suitable for multiple refrigerants: R134a, R407A, R407C, R407 F and R22
- Wide range of quality accessories
- Excellent efficiency
- Filter drier, liquid sight glass and solenoid valve in liquid line

Maximum Allowable Pressure (PS)

- Low Side PS 22.5 bar (g)
- High Side PS 28 bar (g)

Technical Overview

Models	Displacement (m ³ /h)	Receiver Capacity (l)	Number of fans	Total Fan Motor Power (W)	Suction Line Diameter (inch)	Liquid Line Diameter (inch)	Length/Width/Height (mm)	Net Weight (kg)	Motor Version/Code		Maximum Operating Current (A)		Locked Rotor Current (A)		Sound Pressure @10 m (dBA) ***
									1 Ph*	3 Ph**	1 Ph*	3 Ph**	1 Ph*	3 Ph**	
Medium Temperature Models															
OMQ-15	5.9	8.1	1	145	7/8	1/2	630/1050/720	74	PFJ	TFD	12.8	4.9	58.0	26	34
OMQ-21	8.6	8.1	1	145	7/8	1/2	630/1050/720	84	PFJ	TFD	16.4	7.2	82.0	40	35
OMQ-26	10.0	8.1	1	145	7/8	1/2	630/1050/720	85	PFJ	TFD	18.0	8.9	97.0	46	35
OMQ-30	11.7	8.1	1	145	7/8	1/2	630/1050/720	98		TFD		10.3		49	36
OMQ-38	14.4	8.1	1	145	7/8	1/2	642/1250/720	99		TFD		12.8		66	37
OMQ-45	17.1	8.1	1	145	7/8	1/2	642/1250/720	118		TFD		13.1		74	39
OMQ-56	20.9	17.7	2	290	1 3/8	5/8	670/2100/950	224		TWD		15.4		99	44
OMTQ-60	11.8	17.7	2	290	1 3/8	5/8	670/2100/950	209		TFD		10.3		49	42
OMQ-75	28.8	17.7	2	290	1 3/8	5/8	670/2100/950	224		TWD		21.7		127	44
OMTQ-76	14.5	17.7	2	290	1 3/8	5/8	670/2100/950	211		TFD		12.8		66	43
OMTQ-90	17.2	17.7	2	550	1 3/8	5/8	670/2100/950	225		TFD		13.1		74	45
OMQ-92	35.6	17.7	2	550	1 3/8	5/8	670/2100/950	246		TWD		25.1		167	46
OMQ-110	42.8	17.7	2	550	1 5/8	5/8	670/2100/950	255		TWD		29.2		198	47
Digital Medium Temperature Models															
OMQ-30D	11.7	8.1	1	145	7/8	1/2	630/1050/720	98		TFD		7.9		0	36
OMQ-45D	17.1	8.1	1	145	7/8	1/2	642/1250/720	118		TFD		12.1		0	39
OMTQ-60D	23.4	17.7	2	290	1 3/8	5/8	670/2100/950	209		TFD		7.9		0	42
OMTQ-90D	34.1	17.7	2	550	1 3/8	5/8	670/2100/950	225		TFD		12.1		0	45
Low Temperature Models															
OLQ-09	8.0	8.1	1	145	7/8	1/2	630/1050/720	83		TFD		6.0		40	34
OLQ-11	9.9	8.1	1	145	7/8	1/2	630/1050/720	86		TFD		7.1		46	35
OLQ-13	11.8	8.1	1	145	7/8	1/2	630/1050/720	96		TFD		8.0		52	36
OLQ-15	14.5	8.1	1	145	7/8	1/2	642/1250/720	100		TFD		10.0		64	37
OLQ-18	17.1	8.1	1	145	7/8	1/2	642/1250/720	119		TFD		12.5		74	39
OLQ-18V	17.1	7.9	1	145	7/8	1/2	642/1250/720	119		TFD		13.7		74	39
OLQ-24V	20.9	17.7	2	290	1 3/8	5/8	670/2100/950	228		TWD		16.0		99	44
OLTQ-26V	11.8	17.7	2	550	1 3/8	5/8	670/2100/950	221		TFD		9.0		52	42
OLQ-33V	28.8	17.7	2	550	1 3/8	5/8	670/2100/950	228		TWD		21.4		127	44
OLTQ-36V	17.2	17.7	2	550	1 3/8	5/8	670/2100/950	235		TFD		13.7		74	45
OLQ-40V	35.6	17.7	2	550	1 3/8	5/8	670/2100/950	238		TWD		27.0		167	46
OLQ-48V	42.8	17.7	2	550	1 5/8	5/8	670/2100/950	259		TWD		30.6		198	47
Digital Low Temperature Models															
OLQ-18DV	17.1	17.7	2	290	7/8	5/8	670/2100/720	119		TFD		13.8		74	39
OLTQ-36DV	17.1	17.7	2	550	1 3/8	5/8	670/2100/950	235		TFD		13.8		74	45

* 1 Ph: 230V/ 50Hz

** 3 Ph: 380-420V/ 50Hz

*** @ 10m: sound pressure level at 10m distance from the compressor, free field condition

Capacity Data

Ambient Temperature: 32°C															
R134a	Cooling Capacity (kW)							R134a	Power Input (kW)						
	Evaporating Temperature (°C)								Evaporating Temperature (°C)						
	-45	-35	-30	-20	-10	-5	+5		-45	-35	-30	-20	-10	-5	+5
Medium Temperature Models															
OMQ-15-TFD				1.4	2.2	2.7	3.9	OMQ-15-TFD				1.0	1.1	1.1	1.2
OMQ-21-PFJ				1.8	3.0	3.6	5.1	OMQ-21-PFJ				1.4	1.5	1.6	1.7
OMQ-21-TFD				2.0	3.1	3.8	5.4	OMQ-21-TFD				1.4	1.5	1.6	1.8
OMQ-26-PFJ				2.0*	3.3	4.0	5.7	OMQ-26-PFJ				1.8	1.9	2.0	2.1
OMQ-26-TFD				2.3	3.6	4.4	6.3	OMQ-26-TFD				1.6	1.7	1.8	2.0
OMQ-30-TFD				2.5*	4.2	5.1	7.2	OMQ-30-TFD				1.9	2.0	2.1	2.4
OMQ-38-TFD				3.1*	5.3	6.5	9.4	OMQ-38-TFD				2.1	2.3	2.4	2.6
OMQ-45-TFD				3.9*	6.3	7.7	11.0	OMQ-45-TFD				2.5	2.7	2.9	3.2
OMQ-56-TWD				4.6*	7.3*	9.1	13.0	OMQ-56-TWD				3.3	3.6	3.7	4.0
OMQ-75-TWD				6.4*	9.8*	12.3	17.2	OMQ-75-TWD				4.0	4.6	4.9	5.6
OMQ-92-TWD				8.1*	12.6*	15.7	22.2	OMQ-92-TWD				5.4	5.9	6.2	6.8
OMQ-110-TWD				9.9*	15.2*	19.0	26.6	OMQ-110-TWD				6.6	7.3	7.8	8.6

Conditions: EN13215: Suction Gas Return 20°C, Subcooling 0K

* Conditions: EN13215: Suction Superheat 10K

Ambient Temperature: 32°C															
R407A	Cooling Capacity (kW)							R407A	Power Input (kW)						
	Evaporating Temperature (°C)								Evaporating Temperature (°C)						
	Model	-45	-35	-30	-20	-10	-5		+5	Model	-45	-35	-30	-20	-10
OMQ-15-TFD				2.1	3.3	3.9	5.4	OMQ-15-TFD				1.7	1.8	1.9	2.1
OMQ-21-TFD				2.9	4.4	5.2	7.0	OMQ-21-TFD				2.5	2.8	3.0	3.2
OMQ-26-TFD				3.3	5.2	6.1	8.4	OMQ-26-TFD				2.7	3.0	3.2	3.6
OMQ-30-TFD				3.9	6.1	7.2	9.5	OMQ-30-TFD				3.3	3.7	4.0	4.6
OMQ-38-TFD				5.2	8.1	9.7	13.2	OMQ-38-TFD				3.6	4.0	4.2	4.8
OMQ-45-TFD				5.9	9.0	10.6	14.2	OMQ-45-TFD				4.4	5.0	5.3	5.9
OMTQ-60-TFD				6.3*	11.1*	14.0	20.4	OMTQ-60-TFD				5.7*	6.2*	6.5	7.3
OMTQ-76-TFD				9.4*	14.3*	17.3*	24.0	OMTQ-76-TFD				6.9*	7.8*	8.3*	9.6
OMTQ-90-TFD				12.9*	19.3*	23.1	31.5	OMTQ-90-TFD				8.6*	9.2*	9.5	10.4

Conditions: EN13215: Suction Gas Return 20°C, Subcooling 0K

* Suction Superheat 10K

Capacity Data

Ambient Temperature: 32°C															
R407F	Cooling Capacity (kW)							R407F	Power Input (kW)						
	Evaporating Temperature (°C)								Evaporating Temperature (°C)						
Model	-45	-35	-30	-20	-10	-5	+5	Model	-45	-35	-30	-20	-10	-5	+5
Medium Temperature Models															
OMQ-15					3,1	3,7	5,1	OMQ-15					2,0	2,0	2,2
OMQ-21					4.0*	4,9		OMQ-21					3.0*	3,2	
OMQ-26					4.8*	5,9		OMQ-26					3.4*	3,6	
OMQ-30					5.7*	6.9*		OMQ-30					3.9*	4.2*	
OMQ-38					7.8*	9,6	13,3	OMQ-38					4.4*	4,7	5,3
OMQ-45					8.7*	10,8		OMQ-45					5.3*	5,7	
OMTQ-60					12.4*	15,2		OMTQ-60					7.3*	7,7	
OMTQ-76					14.3*	17.2*		OMTQ-76					9.7*	10.3*	
OMTQ-90				11.7*	18.6*	22,9	31,8	OMTQ-90				9.1*	10.3*	10,9	12,2
Digital Medium Temperature Models															
OMQ-30D					6.1*	7.2*		OMQ-30D					3.5*	3.9*	
OMQ-45D					9.1*	11.1		OMQ-45D					5.0*	5.5	
OMQ-60D					12.6*	15.4		OMQ-60D					7.0*	7.5	
OMQ-90D				11.8*	18.9*	23.2	31.7	OMQ-90D				8.6*	10.0*	10.8	12.4
Low Temperature Models															
OLQ-09		1.7	2.1	3.2	4.5	5.3		OLQ-09		1.8	1.8	2.0	2.3	2.5	
OLQ-11		2.0	2.5	3.8	5.3			OLQ-11		2.2	2.3	2.5	2.9		
OLQ-13		2.3	2.9	4.4	6.2			OLQ-13		2.6	2.8	3.2	3.8		
OLQ-15		2.9	3.7	5.6	8.1	9.6	13.0	OLQ-15		2.9	3.1	3.6	4.3	4.7	5.9
OLQ-18		3.5	4.4	6.6	9.4	11.1		OLQ-18		3.7	3.9	4.5	5.2	5.7	

Conditions: EN13215: Suction Gas Return 20°C, Subcooling 0K

* Suction Superheat 10K

Preliminary data

Capacity Data

Ambient Temperature: 32°C															
R404A	Cooling Capacity (kW)							R404A	Power Input (kW)						
	Evaporating Temperature (°C)								Evaporating Temperature (°C)						
	-45	-35	-30	-20	-10	-5	+5		-45	-35	-30	-20	-10	-5	+5
Medium Temperature Models															
OMQ-15			1.4	2.3	3.4	3.9	5.2	OMQ-15			1.8	1.9	2.0	2.0	2.1
OMQ-21			2.0*	3.3	4.6	5.3	6.7	OMQ-21			2.5	2.8	3.0	3.1	3.4
OMQ-26			2.3*	3.9	5.4	6.2	8.1	OMQ-26			2.9	3.2	3.4	3.5	3.8
OMQ-30		2.0*	2.6*	4.3	6.0	6.9	8.9	OMQ-30		3.3	3.4	3.8	4.1	4.3	4.7
OMQ-38		2.7*	3.5	5.8	8.2	9.5	12.4	OMQ-38		3.8	3.9	4.3	4.6	4.8	5.2
OMQ-45		3.1*	3.9*	6.6	9.2	10.6	13.7	OMQ-45		4.5	4.6	5.1	5.5	5.7	6.2
OMQ-56			5.6*	8.3	11.5	13.4	17.4	OMQ-56			5.7	6.2	6.7	6.9	7.5
OMQ-75				11.3	15.3	17.4	22.1	OMQ-75				8.2	9.3	9.8	10.9
OMQ-92				10.2	14.9	20.5	30.7	OMQ-92			9.1	10.2	11.2	11.8	13.1
OMQ-110				17.3	23.7	27.3	35.1	OMQ-110				12.7	14.1	14.8	16.4
OMTQ-60		4.3*	5.5	9.4	13.1	15.1	19.6	OMTQ-60		6.2	6.4	7.0	7.5	7.8	8.4
OMTQ-76		5.1*	6.5	11.1	15.1	17.3		OMTQ-76		8.1	8.4	9.3	10.1	10.6	
OMTQ-90		6.5*	9.5	14.2	19.9	23.1	30.2	OMTQ-90		8.7	9.1	9.7	10.3	10.7	11.5
Low Temperature Models															
OLQ-09		1.9	2.3	3.3	4.5	5.2	6.6	OLQ-09		2.0	2.0	2.3	2.6	2.7	3.2
OLQ-11		2.4	2.8	3.9	5.2	5.9	7.5	OLQ-11		2.4	2.5	2.8	3.2	3.5	4.1
OLQ-13		2.7	3.3	4.7	6.3	7.1	9.0	OLQ-13		2.6	2.7	3.1	3.6	3.9	4.5
OLQ-15		3.4	4.2	6.1	8.3	9.5	12.2	OLQ-15		3.0	3.2	3.6	4.2	4.5	5.3
OLQ-18		4.1	5.0	7.1	9.6	10.9	13.8	OLQ-18		3.7	3.9	4.4	5.0	5.3	6.1
OLQ-24V		7.2	8.8	12.3	16.4	18.6	23.3	OLQ-24V		5.6	6.0	6.9	7.9	8.6	10.1
OLQ-33V		9.9	12.0	16.9	22.8	26.2	33.7	OLQ-33V		7.5	7.9	8.9	10.0	10.7	12.3
OLQ-40V		11.9	15.0	21.5	28.5	32.1	39.3	OLQ-40V		8.7	9.9	12.0	14.1	15.1	17.5
OLQ-48V		14.7	17.7	24.1	30.9	34.4		OLQ-48V		11.2	12.2	14.8	18.2	20.3	
OLTQ-26V		8.0	9.7	13.9	19.3	22.5	30.1	OLTQ-26V		6.3	6.6	7.3	8.1	8.5	9.4
Digital Medium Temperature Models															
OMQ-30D			2.8*	4.6	6.2	7.0	8.8	OMQ-30D			2.5	3.2	3.7	3.9	4.5
OMQ-45D			3.6*	6.6	9.6	11.4	15.5	OMQ-45D			4.2	4.8	5.5	5.9	6.9
OMTQ-60D			5.7*	9.5	13.1	15.2	19.7	OMTQ-60D			5.6	6.5	7.2	7.5	8.3
OMTQ-90D			7.9*	13.9	20.0	23.5	31.5	OMTQ-90D			8.7	9.6	10.4	10.9	12.1
Digital Low Temperature Models															
OLQ-18DV		5.9	6.9	9.5	12.8	14.7		OLQ-18DV		4.5	4.9	5.8	7.0	7.7	
OLTQ-36DV		11.9	14.1	19.5	26.4	30.6		OLTQ-36DV		8.8	9.4	10.9	12.6	13.6	

Conditions: EN13215: Suction Gas Return 20°C, Subcooling 0K

* Conditions: EN13215: Suction Superheat 10K

Ambient Temperature: 32°C															
R407C	Cooling Capacity (kW)							R407C	Power Input (kW)						
	Evaporating Temperature (°C)								Evaporating Temperature (°C)						
	-45	-35	-30	-20	-10	-5	+5		-45	-35	-30	-20	-10	-5	+5
Medium Temperature Models															
OMQ-15-TFD				1.9*	2.9	3.5	4.9	OMQ-15-TFD				1.4	1.5	1.6	1.7
OMQ-21-PFJ				2.4*	3.8*	4.7	6.5	OMQ-21-PFJ				2.2	2.4	2.6	2.9
OMQ-21-TFD				2.7*	4.1*	4.9	6.9	OMQ-21-TFD				2.3	2.5	2.7	3.0
OMQ-26-PFJ					4.3*	5.1*	7.2	OMQ-26-PFJ					3.0	3.2	3.7
OMQ-26-TFD				2.8*	4.4*	5.5	7.8	OMQ-26-TFD				2.4	2.6	2.8	3.1
OMQ-30-TFD				3.4*	5.3*	6.4	8.9	OMQ-30-TFD				2.9	3.3	3.6	4.1
OMQ-38-TFD				4.1*	6.8*	8.5	12.2	OMQ-38-TFD				3.2	3.6	3.8	4.4
OMQ-45-TFD				5.9*	8.0*	10.0	13.8	OMQ-45-TFD				3.9	4.4	4.7	5.4
OMQ-56-TWD				6.9*	10.4*	12.7	17.4	OMQ-56-TWD				5.3	5.8	6.1	6.6
OMQ-75-TWD				9.3*	13.7*	16.2*	22.2	OMQ-75-TWD				6.7	7.7	8.2	9.4
OMQ-92-TWD				12.0*	17.8*	21.7	29.6	OMQ-92-TWD				8.4	9.4	10.0	11.1
OMQ-110-TWD				14.2*	21.1*	25.6	34.7	OMQ-110-TWD				10.6	12.0	12.8	14.4
OMTQ-60-TFD				7.2*	11.3*	13.9	19.3	OMTQ-60-TFD				5.6	6.2	6.6	7.4
OMTQ-76-TFD				8.1*	12.9*	15.7*	22.3	OMTQ-76-TFD				6.8	7.8	8.4	9.8
OMTQ-90-TFD				10.6*	17.0*	21.0	29.3	OMTQ-90-TFD				7.8	8.6	9.1	10.1

Conditions: EN13215: Suction Gas Return 20°C, Subcooling 0K

* Conditions: EN13215: Suction Superheat 10K

Copeland EazyCool™ Outdoor Condensing Units for Refrigeration Networks

Copeland™ outdoor condensing unit networks for medium-temperature and low-temperature applications.

Emerson Climate Technologies has developed this version of outdoor scroll condensing units with interconnectivity in order to create medium and large refrigeration network systems.

The EazyCool condensing unit networks perfectly fit in applications where larger cooling capacities and capacity modulation are required.

Typical applications are:

- Cold and freeze stores
- Discount and convenience stores
- Supermarkets and mini-markets
- Petrol station forecourts



Copeland EazyCool Outdoor Condensing Units for Refrigeration Networks

Copeland EazyCool Network Line-up

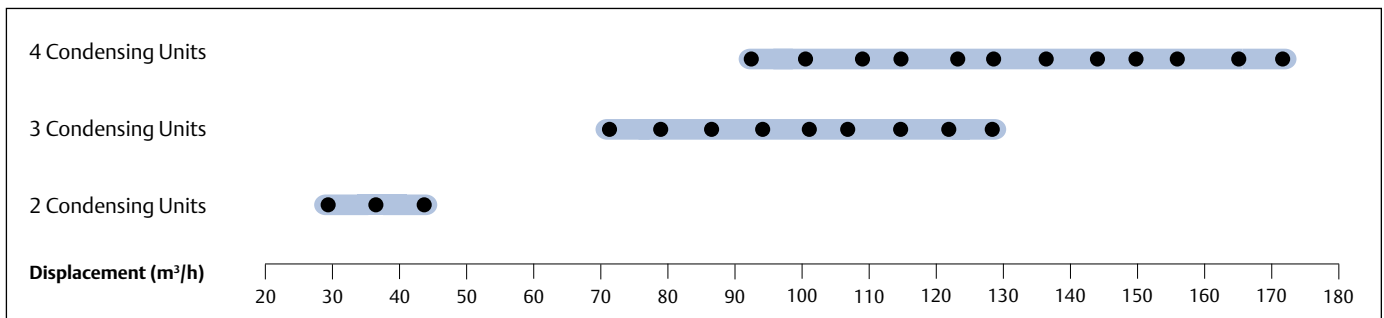

Conditions EN13215 R404A: Evaporating Temperature MT -10°C/LT -35°C, Ambient Temperature 32°C, Suction Gas Return 20°C

Features and Benefits

- Standard equipment: Copeland Scroll™ compressor(s), crankcase heater(s), condenser with thermally protected low speed fan(s), fan speed controller, oil separator, suction and liquid equalization lines, HP and LP switch, oil reservoir, EC2 Electronic controller, weather-resistant housing
- Oil control system with oil separator, TRAX OIL on each compressor, oil distribution lines and additional liquid receiver unit for large networks
- LON Master/Slave communication
- Capacity modulation with up to 8 compressors or stepless with Digital Scroll
- Perfect capacity adjustment by a wide range of combination opportunities

Maximum Allowable Pressures (PS)

- Low Side PS 22.5 bar(g)
- High Side PS 28 bar(g)

Capacity Data - OMQ

Medium Temperature (-10/+32°C)								
Displacement (m³/h)	Motor Capacity (kW)	Model Configuration						
2 Condensing Units Network								
28.8	14.8	OMQ75 NLO	+	OMQ56 NL				
28.8	17.1	OMQ75 NLO	+	OMQ75 NL				
35.6	19.7	OMQ92 NLO	+	OMQ75 NL				
35.6	22.2	OMQ92 NLO	+	OMQ92 NL				
42.8	25.1	OMQ110 NLO	+	OMQ 92 NL				
42.8	28.0	OMQ110 NLO	+	OMQ110 NL				
3 Condensing Units Network								
70.6	21.0	OMQ75 NO	+	OMQ56 N	+	OMQ56 N		
78.5	23.3	OMQ75 NO	+	OMQ75 N	+	OMQ56 N		
86.4	25.7	OMQ75 NO	+	OMQ75 N	+	OMQ75 N		
93.2	28.2	OMQ92 NO	+	OMQ75 N	+	OMQ75 N		
100.0	30.8	OMQ92 NO	+	OMQ92 N	+	OMQ75 N		
106.8	33.3	OMQ92 NO	+	OMQ92 N	+	OMQ92 N		
114.0	36.2	OMQ110 NO	+	OMQ92 N	+	OMQ92 N		
121.2	39.1	OMQ110 NO	+	OMQ110 N	+	OMQ92 N		
128.4	42.0	OMQ110 NO	+	OMQ110 N	+	OMQ110 N		
4 Condensing Units Network								
91.5	27.2	OMQ75 NO	+	OMQ56 N	+	OMQ56 N	+	OMQ56 N
99.4	29.5	OMQ75 NO	+	OMQ75 N	+	OMQ56 N	+	OMQ56 N
107.3	31.9	OMQ75 NO	+	OMQ75 N	+	OMQ75 N	+	OMQ56 N
115.2	34.2	OMQ75 NO	+	OMQ75 N	+	OMQ75 N	+	OMQ75 N
122.0	36.8	OMQ92 NO	+	OMQ75 N	+	OMQ75 N	+	OMQ75 N
128.8	39.3	OMQ92 NO	+	OMQ92 N	+	OMQ75 N	+	OMQ75 N
135.6	41.9	OMQ92 NO	+	OMQ92 N	+	OMQ92 N	+	OMQ75 N
142.4	44.4	OMQ92 NO	+	OMQ92 N	+	OMQ92 N	+	OMQ92 N
149.6	47.3	OMQ110 NO	+	OMQ92 N	+	OMQ92 N	+	OMQ92 N
156.8	50.2	OMQ110 NO	+	OMQ110 N	+	OMQ92 N	+	OMQ92 N
164.0	53.1	OMQ110 NO	+	OMQ110 N	+	OMQ110 N	+	OMQ92 N
171.2	56.0	OMQ110 NO	+	OMQ110 N	+	OMQ110 N	+	OMQ110 N

Conditions: EN13215: Suction Gas Return 20°C, Suction Superheat 10K

Capacity Data - OLQ

R404A		Low Temperature (-35/+32°C)						
Cooling Capacity (kW)	Motor Capacity (kW)	Model Configuration						
2 Condensing Units Network								
16.4	13.9	OLQ33V NLO	+	OLQ24V NL				
18.7	16.4	OLQ33V NLO	+	OLQ33V NL				
20.9	17.0	OLQ40V NLO	+	OLQ33V NL				
23.0	17.6	OLQ40V NLO	+	OLQ40V NL				
25.4	20.6	OLQ48V NLO	+	OLQ40V NL				
27.8	23.6	OLQ48V NLO	+	OLQ48V NL				
3 Condensing Units Network								
23.4	19.6	OLQ33V NO	+	OLQ24V N	+	OLQ24V N		
25.7	22.1	OLQ33V NO	+	OLQ33V N	+	OLQ24V N		
28.1	24.6	OLQ33V NO	+	OLQ33V N	+	OLQ33V N		
30.2	25.2	OLQ40V NO	+	OLQ33V N	+	OLQ33V N		
32.4	25.8	OLQ40V NO	+	OLQ40V N	+	OLQ33V N		
34.5	26.4	OLQ40V NO	+	OLQ40V N	+	OLQ40V N		
36.9	29.4	OLQ48V NO	+	OLQ40V N	+	OLQ40V N		
39.3	32.4	OLQ48V NO	+	OLQ48V N	+	OLQ40V N		
41.7	35.4	OLQ48V NO	+	OLQ48V N	+	OLQ48V N		
4 Condensing Units Network								
30.4	25.3	OLQ33V NO	+	OLQ24V N	+	OLQ24V N	+	OLQ24V N
32.7	27.8	OLQ33V NO	+	OLQ33V N	+	OLQ24V N	+	OLQ24V N
35.1	30.3	OLQ33V NO	+	OLQ33V N	+	OLQ33V N	+	OLQ24V N
37.4	32.8	OLQ33V NO	+	OLQ33V N	+	OLQ33V N	+	OLQ33V N
39.6	33.4	OLQ40V NO	+	OLQ33V N	+	OLQ33V N	+	OLQ33V N
41.7	34.0	OLQ40V NO	+	OLQ40V N	+	OLQ33V N	+	OLQ33V N
43.9	34.6	OLQ40V NO	+	OLQ40V N	+	OLQ40V N	+	OLQ33V N
46.0	35.2	OLQ40V NO	+	OLQ40V N	+	OLQ40V N	+	OLQ40V N
48.4	38.2	OLQ48V NO	+	OLQ40V N	+	OLQ40V N	+	OLQ40V N
50.8	41.2	OLQ48V NO	+	OLQ48V N	+	OLQ40V N	+	OLQ40V N
53.2	44.2	OLQ48V NO	+	OLQ48V N	+	OLQ48V N	+	OLQ40V N
55.6	47.2	OLQ48V NO	+	OLQ48V N	+	OLQ48V N	+	OLQ48V N

Conditions: EN13215: Suction Gas Return 20°C, Suction Superheat 10K

Copeland EazyCool™ ZX Outdoor Condensing Units with Scroll Compressors

Copeland™ compact outdoor condensing units are for medium-temperature and low-temperature applications.

With this new range of outdoor condensing units, Emerson Climate Technologies offers a solution for refrigeration applications with space and noise constraints which responds to the increasing demand for energy-efficient condensing units.

Copeland EazyCool ZX outdoor condensing units feature the most complete and unique equipment. Their diagnostics module detects and displays the system status and it can communicate and transmit an alarm signal to a remote receiver. Vapor injection and liquid injection technology significantly increase system efficiency and operation map. Electronic protection functions, oil separator and suction accumulator guarantee optimum system safety.

Lowest life cycle costs and comprehensive safety features make Copeland EazyCool ZX a cost efficient and reliable choice for:

- Convenience stores
- Cold rooms
- Fast food stores, bars and restaurants
- Beverage coolers



Copeland EazyCool ZX Outdoor Condensing Units with Scroll Compressors

Copeland EazyCool ZX Line-up

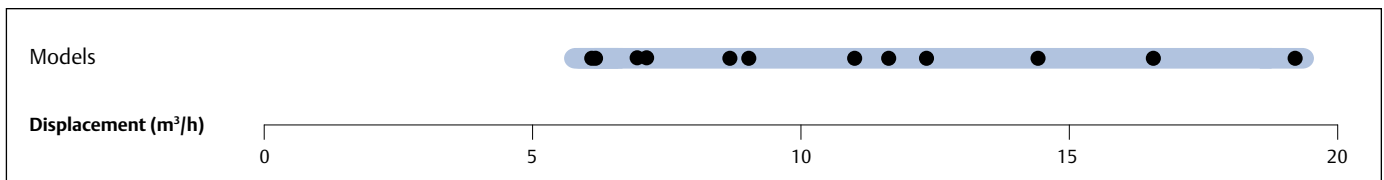

Copeland EazyCool ZX Digital Line-up

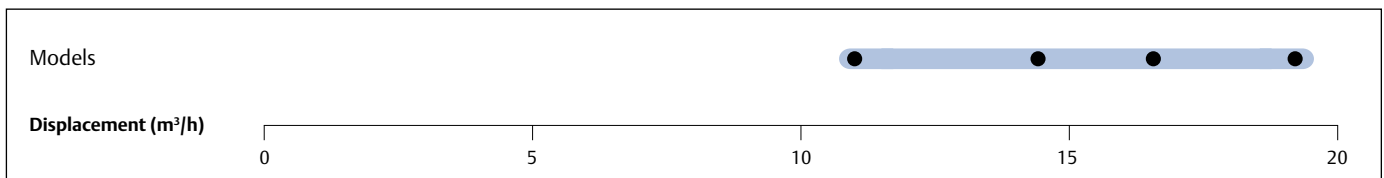

Features and Benefits

- Standard equipment: Copeland Scroll™ compressor, crankcase heater, diagnostics module, fan(s) with speed control, liquid receiver, adjustable LP switch, safety switches, filter drier and sight glass, oil separator and suction accumulator (LT models only)
- Copeland EazyCool ZX Digital models allow for 10% to 100% continuous capacity modulation
- Diagnostic capabilities protect the unit from over-current, phase loss and phase imbalance
- LED display shows real time system status
- Energy and operation cost saving due to excellent energy efficiency
- Noise attenuation due to low speed fan motors with sickle blades, fan speed control and sound jacket
- Vapor injection technology for LT models
- Space saving due to compact dimensions
- Easy and quick installation

Maximum Allowable Pressures (PS)

- Low Side PS 22.5 bar (g)
- High Side PS 28.8 bar (g)

Technical Overview

Models	Displacement (m ³ /h)	Receiver Capacity (l)	Number of fans	Total Fan Motor Power (W)	Suction Line Diameter (inch)	Liquid Line Diameter (inch)	Length/Width/Height (mm)	Net Weight (kg)	Motor Version/Code		Maximum Operating Current, A		Locked Rotor Current, A		Sound Pressure @10 m - d(BA)***		
									1 Ph*	3 Ph**	1 Ph*	3 Ph**	1 Ph*	3 Ph**	Night mode	Day mode	
Medium Temperature Models																	
ZXME020E	5.9	4.4	1	116	3/4	1/2	424/1029/840	76	PFJ	TFD	12.8	4.9	58	26	39	39	
ZXME025E	6.8	4.4	1	116	3/4	1/2	424/1029/840	79	PFJ		12.4		61		40	40	
ZXME030E	8.6	4.4	1	116	3/4	1/2	424/1029/840	79	PFJ	TFD	16.4	7.2	82	40	40	40	
ZXME040E	11.7	4.4	1	116	7/8	1/2	424/1029/840	91	PFJ	TFD	23.5	10.3	114	49.3	40	40	
ZXME050E	14.4	6.3	2	246	7/8	1/2	424/1029/1242	108		TFD		12.8		65.5	41	41	
ZXME060E	17.1	6.3	2	246	7/8	1/2	424/1029/1242	112		TFD		13.1		74	41	41	
ZXME075E	18.8	6.3	2	246	7/8	1/2	424/1029/1242	118		TFD		14		101	42	42	
Medium Temperature Digital Models																	
ZXDE040E	11.4	6.3	2	246	7/8	1/2	424/1029/1242	104		TFD		7.9		48	40	40	
ZXDE050E	14.4	6.3	2	246	7/8	1/2	424/1029/1242	108		TFD		11.3		64	41	41	
ZXDE060E	17.1	6.3	2	246	7/8	1/2	424/1029/1242	112		TFD		11.4		74	41	41	
ZXDE075E	18.8	6.3	2	246	7/8	1/2	424/1029/1242	118		TFD		14		100	42	42	
Low Temperature Models																	
ZXLE020E	6.1	4.4	1	116	3/4	1/2	424/1029/840	79	PFJ	TFD	13.6	5.7	56.6	39.2	39	39	
ZXLE025E	7.1	4.4	1	116	3/4	1/2	424/1029/840	79	PFJ	TFD	15.6	6.1	73.7	39.2	39	39	
ZXLE030E	8.0	4.4	1	116	3/4	1/2	424/1029/840	81	PFJ	TFD	17.8	6.7	82.3	35.7	40	40	
ZXLE040E	12.7	4.4	1	116	7/8	1/2	424/1029/840	93		TFD		9.2		51.5	40	40	
ZXLE050E	14.4	6.3	2	246	7/8	1/2	424/1029/1242	106		TFD		11.9		51.5	41	41	
ZXLE060E	17.1	6.3	2	246	7/8	1/2	424/1029/1242	116		TFD		13.7		74	41	41	
ZXLE075E	18.8	6.3	2	246	7/8	1/2	424/1029/1242	121		TFD		14.6		101	41		

* 1 Ph: 230V/ 50Hz

** 3 Ph: 380-420V/ 50Hz

*** @ 10m: sound pressure level at 10m distance from the compressor, free field condition

Capacity Data

Ambient Temperature: 32°C																	
R134a	Cooling Capacity (kW)							R134a	Power Input (kW)								
	Evaporating Temperature (°C)								Evaporating Temperature (°C)								
Model	-45	-35	-30	-20	-10	-5	+5	Model	-45	-35	-30	-20	-10	-5	+5		
Medium Temperature Models																	
ZXME020E				1.4	2.3	2.8	4.0	ZXME020E				1.0	1.0	1.0	1.1		
ZXME025E				1.5	2.6	3.2	4.7	ZXME025E				1.2	1.3	1.3	1.4		
ZXME030E				2.1	3.2	4.0	5.8	ZXME030E				1.3	1.4	1.4	1.5		
ZXME040E				2.8	4.4	5.4	7.8	ZXME040E				1.7	1.8	1.9	2.0		
ZXME050E				3.4	5.5	6.8	9.9	ZXME050E				2.2	2.3	2.4	2.5		
ZXME060E				4.2	6.5	8.0	11.7	ZXME060E				2.5	2.7	2.7	3.0		
ZXME075E				4.8	7.5	9.1	13.2	ZXME075E				3.1	3.2	3.3	3.6		
Digital Medium Temperature Models																	
ZXDE-040E				4.3	5.3	8.0		ZXDE-040E					1.8	1.9	2.0		
ZXDE-050E				5.3	6.5	9.7		ZXDE-050E					2.3	2.4	2.5		
ZXDE-060E				6.3	7.9	11.7		ZXDE-060E					2.7	2.8	3.0		
ZXDE-075E				7.2	8.8	12.7		ZXDE-075E					3.0	3.0	3.3		

Conditions: EN13215: Suction Gas Return 20°C, Subcooling 0K

Preliminary Data

Capacity Data

Ambient Temperature: 32°C															
R407A	Cooling Capacity (kW)							R407A	Power Input (kW)						
	Evaporating Temperature (°C)								Evaporating Temperature (°C)						
Model	-45	-35	-30	-20	-10	-5	+5	Model	-45	-35	-30	-20	-10	-5	+5
Medium Temperature Models															
ZXME020E				2.4	3.5	4.1	5.6	ZXME020E				1.6	1.7	1.7	1.7
ZXME025E				2.5	3.9	4.7	6.6	ZXME025E				1.6	1.7	1.8	1.9
ZXME030E				3.2	4.9	5.9	8.3	ZXME030E				2.1	2.3	2.4	2.6
ZXME040E				4.5	6.9	8.3	11.5	ZXME040E				2.9	3.2	3.3	3.7
ZXME050E				5.8	8.7	10.4	14.4	ZXME050E				3.5	3.7	3.9	4.3
ZXME060E				6.4	9.8	11.8	16.4	ZXME060E				4.0	4.3	4.5	5.0
ZXME075E				7.4	11.3	13.6	18.9	ZXME075E				4.5	4.9	5.1	5.6
Digital Medium Temperature Models															
ZXDE-040E				4.7	7.3	8.8	12.5	ZXDE-040E				2.7	2.8	2.9	3.1
ZXDE-050E				5.8	8.7	10.4	14.4	ZXDE-050E				3.5	3.7	3.9	4.3
ZXDE-060E				6.4	9.8	11.8	16.4	ZXDE-060E				4.0	4.3	4.5	5.0
ZXDE-075E				7.4	11.3	13.6	18.9	ZXDE-075E				4.5	4.9	5.1	5.6
Low Temperature Models															
ZXLE020E		1.5	1.9	3.0	4.3	5.1	6.7	ZXLE020E		1.4	1.5	1.6	1.7	1.8	2.0
ZXLE025E		1.8	2.2	3.4	5.0	5.9	7.9	ZXLE025E		1.6	1.7	1.8	2.0	2.0	2.3
ZXLE030E		2.0	2.5	3.9	5.6	6.6	8.7	ZXLE030E		1.8	1.9	2.0	2.2	2.3	2.5
ZXLE040E		3.2	3.9	6.0	8.5	9.9	12.9	ZXLE040E		2.6	2.8	3.2	3.8	4.1	4.8
ZXLE050E		3.6	4.5	6.8	9.7	11.4	14.8	ZXLE050E		3.0	3.2	3.7	4.3	4.6	5.4
ZXLE060E		4.2	5.3	7.9	11.3	13.1		ZXLE060E		3.7	3.9	4.5	5.3	5.7	
ZXLE075E		4.8	5.9	9.0	13.0	15.2	19.9	ZXLE075E		3.8	4.0	4.6	5.3	5.8	6.7

Conditions: EN13215: Suction Gas Return 20°C, Subcooling 0K Preliminary Data

Ambient Temperature: 32°C															
R407F	Cooling Capacity (kW)							R407F	Power Input (kW)						
	Evaporating Temperature (°C)								Evaporating Temperature (°C)						
Model	-45	-35	-30	-20	-10	-5	+5	Model	-45	-35	-30	-20	-10	-5	+5
Medium Temperature Models															
ZXME020E					3.4	4.1	5.7	ZXME020E					1.6	1.7	1.7
ZXME025E				3.3	5.0	6.0	8.4	ZXME025E				2.2	2.3	2.5	2.7
ZXME030E					4.9	5.9	8.3	ZXME030E					2.3	2.4	2.6
ZXME040E				4.4*	6.9	8.3	11.5	ZXME040E				2.9*	3.2	3.3	3.7
ZXME050E				5.7*	8.6	10.4	14.4	ZXME050E				3.5*	3.7	3.9	4.3
ZXME060E				6.2*	9.7	11.8	16.4	ZXME060E				4.0*	4.3	4.5	5.0
ZXME075E				7.1*	11.2	13.6	18.9	ZXME075E				4.5*	4.9	5.1	5.6
Medium Temperature Digital Models															
ZXDE040E				4.7	7.2	8.8	12.4	ZXDE040E				2.8	2.9	3.0	3.2
ZXDE050E				5.7	8.6	10.5	14.6	ZXDE050E				3.7	3.9	4.1	4.5
ZXDE060E				5.9	9.0	10.9	15.1	ZXDE060E				3.9	4.2	4.4	4.8
ZXDE075E				6.7	10.2	12.3	17.2	ZXDE075E				4.3	4.6	4.8	5.2
Low Temperature Models															
ZXLE020E		1.6	2.0	3.1	4.5	5.3	7.0	ZXLE020E		1.5	1.6	1.7	1.8	1.9	2.2
ZXLE025E		1.8	2.3	3.6	5.3	6.2	8.2	ZXLE025E		1.7	1.8	1.9	2.1	2.2	2.4
ZXLE030E		2.1	2.6	4.0	5.9	6.9	9.1	ZXLE030E		1.9	2.0	2.1	2.3	2.4	2.7
ZXLE040E		3.3	4.1	6.3	8.9	10.4	13.5	ZXLE040E		2.8	2.9	3.4	4.0	4.4	5.1
ZXLE050E		3.8	4.7	7.1	10.2	11.9	15.4	ZXLE050E		3.2	3.4	3.9	4.5	4.9	5.7
ZXLE060E		4.4	5.5	8.3	11.8	13.7		ZXLE060E		3.9	4.1	4.8	5.6	6.1	
ZXLE075E		5.0	6.2	9.4	13.6	15.9	20.8	ZXLE075E		4.0	4.3	4.9	5.7	6.1	7.1

Conditions: EN13215: Suction Gas Return 20°C, Subcooling 0K Preliminary Data * 10K border

Capacity Data

Ambient Temperature: 32°C															
R404A	Cooling Capacity (kW)							R404A	Power Input (kW)						
	Evaporating Temperature (°C)								Evaporating Temperature (°C)						
	-45	-35	-30	-20	-10	-5	+5		-45	-35	-30	-20	-10	-5	+5
Medium Temperature Models															
ZXME020E-TFD				2.4	3.6	4.2	5.7	ZXME020E-TFD				1.8	1.8	1.8	1.8
ZXME020E-PFJ				2.5	3.6	4.3	5.7	ZXME020E-PFJ				1.5	1.6	1.7	1.7
ZXME025E-PFJ				3.0	4.3	5.1	6.9	ZXME025E-PFJ				1.9	2.0	2.0	2.1
ZXME030E-TFD				3.7	5.3	6.2	8.2	ZXME030E-TFD				2.4	2.5	2.6	2.7
ZXME030E-PFJ				3.8	5.3	6.2	8.3	ZXME030E-PFJ				2.5	2.6	2.7	2.8
ZXME040E-TFD				5.0	7.0	8.2	10.8	ZXME040E-TFD				3.2	3.4	3.5	3.8
ZXME040E-PFJ				4.7	6.8	8.0	10.6	ZXME040E-PFJ				3.2	3.4	3.5	3.8
ZXME050E-TFD				6.4	9.1	10.7	14.4	ZXME050E-TFD				4.0	4.1	4.3	4.5
ZXME060E-TFD				7.3	10.4	12.2	16.2	ZXME060E-TFD				4.6	4.8	5.0	5.3
ZXME075E-TFD				8.4	11.9	13.9	18.5	ZXME075E-TFD				5.1	5.4	5.5	5.9
Digital Models															
ZXDE040E-TFD				5.0	7.0	8.1	10.7	ZXDE040E-TFD				2.8	3.2	3.3	3.7
ZXDE050E-TFD				6.4	9.0	10.6	14.1	ZXDE050E-TFD				3.6	4.0	4.2	4.7
ZXDE060E-TFD				7.4	10.4	12.2	16.1	ZXDE060E-TFD				4.3	4.9	5.2	5.8
ZXDE075E-TFD				8.4	11.8	13.8	18.2	ZXDE075E-TFD				4.7	5.3	5.6	6.3
Low Temperature Models															
ZXLE020E		1.9	2.4	3.5	4.9	5.7		ZXLE020E		1.6	1.7	1.9	2.1	2.1	
ZXLE025E		2.2	2.8	4.1	5.8	6.8		ZXLE025E		1.9	2.0	2.2	2.4	2.4	
ZXLE030E		2.6	3.2	4.6	6.4	7.4		ZXLE030E		2.1	2.2	2.3	2.5	2.6	
ZXLE040E		4.0	4.9	7.0	9.6	11.0		ZXLE040E		3.0	3.2	3.6	4.1	4.4	
ZXLE050E		5.0	6.0	8.5	11.5	13.2		ZXLE050E		3.6	3.9	4.4	5.0	5.3	
ZXLE060E		5.8	7.0	9.9	13.2	15.0		ZXLE060E		4.4	4.7	5.4	6.2	6.7	
ZXLE075E		6.5	7.9	11.2	15.3	17.6		ZXLE075E		4.6	4.9	5.5	6.2	6.6	

Conditions: EN13215: Suction Gas Return 20°C, Subcooling 0K

Copeland Scroll™ Indoor Condensing Units for Refrigeration

Copeland™ air-cooled condensing units for medium temperature and low temperature applications.

Copeland Scroll condensing units are equipped with the latest refrigeration scroll compressors and build the widest range of its kind. The modular line concept offers base units which can be adapted to the target application by various options including weather housings and fan speed controls.

Copeland Scroll condensing units are available with normal or high capacity condensers to ensure optimum performance even under extreme conditions. They are equipped with dedicated medium or low temperature compressors which makes them suitable for all general refrigeration applications, such as:

- Mini markets and supermarkets
- Bars, restaurants and kitchens
- Beer cellars and beverage coolers
- Cold rooms
- Milk cooling tank



*Copeland Scroll
Indoor Condensing Unit*

Copeland Scroll Condensing Units Line-up

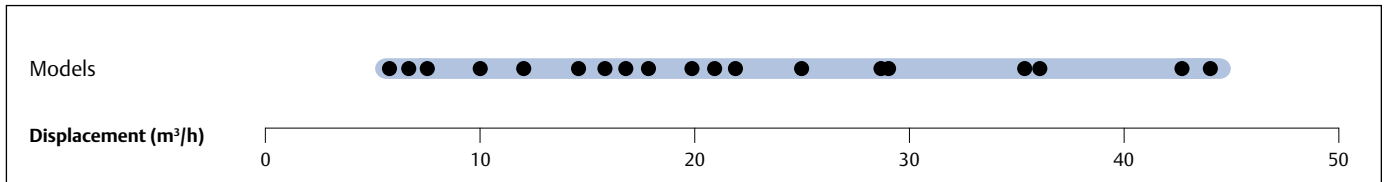

Copeland Scroll Digital Condensing Units Line-up

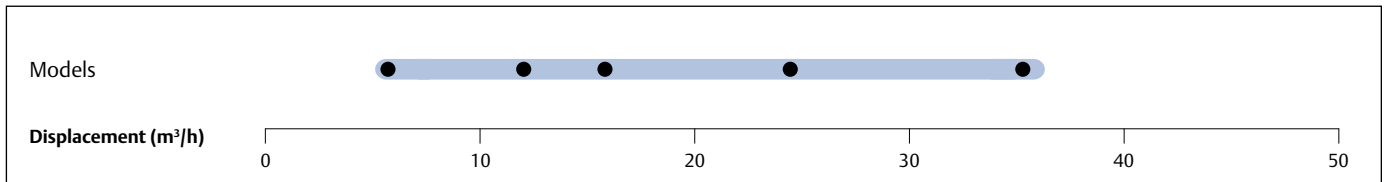

Features and Benefits

- Standard equipment: base plate, scroll compressor, crank case heater, condenser with 1ph fan(s), HP and LP switch, liquid receiver with rotalock-valve, suction- and discharge shut-off valves
- Suitable for multiple refrigerants: R404A, R407C, R134a, R407A and R407F
- Wide range of quality accessories
- Excellent efficiency and reliability

Maximum Allowable Pressures (PS)

- Low Side PS 22.5 bar (g)
- High Side PS = 28 bar (g)

Technical Overview

Models	Displacement (m ³ /h)	Receiver Capacity (l)	Number of fans	Total Fan Motor Power (W)	Suction Line Diameter (inch)	Liquid Line Diameter (inch)	Length/Width/Height (mm)	Net Weight (kg)	Motor Version/Code		Maximum Operating Current, A		Locked Rotor Current, A		Sound Pressure @10 m - d(BA)***	
									1 Ph*	3 Ph**	1 Ph*	3 Ph**	1 Ph*	3 Ph**		
Medium Temperature Models																
MC-D8-ZB15KE	5.9	3.9	1	110	¾	½	570/560/446	48	PFJ	TFD	12.8	4.9	58	26	45.8	
MC-H8-ZB15KE	5.9	7.9	1	235	¾	½	680/735/533	57	PFJ	TFD	12.8	4.9	58	26	48.6	
MC-D8-ZB19KE	6.8	3.9	1	110	¾	½	570/560/446	49	PFJ	TFD	12.8	6.5	61	32	45.9	
MC-H8-ZB19KE	6.8	7.9	1	235	¾	½	680/735/533	61	PFJ	TFD	12.8	6.5	61	32	48.7	
MC-K9-ZB19KE	6.8	7.9	2	220	¾	½	640/950/454	66.5	PFJ	TFD	12.8	6.5	61	32	47.5	
MC-D8-ZB21KE	8.6	3.9	1	110	¾	½	570/560/446	50	PFJ	TFD	16.42	7.2	82	40	46.4	
MC-H8-ZB21KE	8.6	7.9	1	235	¾	½	680/735/533	61	PFJ	TFD	16.42	7.2	82	40	48.9	
MC-K9-ZB21KE	8.6	7.9	2	220	¾	½	640/950/454	67.5	PFJ	TFD	16.42	7.2	82	40	47.8	
MC-H8-ZB26KE	10.0	7.9	1	235	¾	½	680/735/533	62	PFJ	TFD	18	8.85	97	46	48.9	
MC-K9-ZB26KE	10.0	7.9	2	220	¾	½	640/950/454	68	PFJ	TFD	18	8.85	97	46	47.8	
MC-H8-ZB30KE	11.7	7.9	1	235	¾	½	680/735/533	74	PFJ	TFD	26.4	10.3	142	49.3	49.1	
MC-M8-ZB30KE	11.7	7.9	1	235	¾	½	730/735/708	86.5	PFJ	TFD	26.4	10.3	142	49.3	48.6	
MC-P8-ZB30KE	11.7	7.9	2	220	¾	½	640/950/633	86.5		TFD		10.3		49.3	48.5	
MC-H8-ZB38KE	14.4	7.9	1	235	¾	½	680/735/533	77	PFJ	TFD	32.3	12.8	142	65.5	49.2	
MC-M8-ZB38KE	14.4	7.9	1	235	¾	½	730/735/708	89	PFJ	TFD	32.3	12.8	142	65.5	48.8	
MC-P8-ZB38KE	14.4	7.9	2	220	¾	½	640/950/633	89	PFJ	TFD	32.3	12.8	142	65.5	48.7	
MC-M8-ZB42KE	16.2	7.9	1	235	¾	½	730/735/708	91	PFJ		35.7		150		49.4	
MC-R7-ZB42KE	16.2	7.9	2	470	¾	½	680/1130/633	101	PFJ		35.7		150		52.7	
MC-M8-ZB45KE	17.1	7.9	1	235	¾	½	730/735/708	91		TFD		13.1		74	49.4	
MC-M9-ZB45KE	17.1	7.9	1	400	¾	½	730/735/708	95.5		TFD		13.1		74	49.4	
MC-R7-ZB45KE	17.1	7.9	2	470	¾	½	680/1130/633	101		TFD		13.1		74	49.5	
MC-R7-ZB50KE	19.8	7.9	2	470	1 ⅜	½	820/1130/621	110		TFD		14.6		100	49.3	
MC-S9-ZB50KE	19.8	11.7	2	470	1 ⅜	⅝	820/1130/703	113		TFD		14.6		100	49.7	
MC-R7-ZB56KE	20.9	7.9	2	470	1 ⅜	½	820/1130/633	158		TWD		15.4		99	55.0	
MC-S9-ZB56KE	20.9	11.7	2	470	1 ⅜	⅝	820/1130/708	170		TWD		15.4		99	54.7	
MC-R7-ZB58KE	22.1	7.9	2	470	1 ⅜	½	820/1130/621	110		TFD		15.6		95		
MC-S9-ZB58KE	22.1	11.7	2	470	1 ⅜	⅝	820/1130/703	113		TFD		15.6		95		
MC-S9-ZB66KE	24.9	11.7	2	470	1 ⅜	⅝	820/1130/707	116		TFD		17.5		111	50.3	
MC-V9-ZB66KE	24.9	15.8	2	470	1 ⅜	¾	820/1330/821	150		TFD		17.5		111	50.2	
MC-V9-ZB75KE	28.8	15.8	2	470	1 ⅜	¾	820/1330/835	195		TWD		21.7		127	54.7	
MC-V9-ZF33KE	28.8	11.7	2	470	1 ⅜	⅝	820/1330/835	195		TWD		22.3		127	54.7	
MC-V6-ZB75KE	28.8	15.8	2	800	1 ⅜	¾	820/1330/835	207		TWD		21.7		127	57.4	
MC-V9-ZB76KE	29.1	15.8	2	470	1 ⅜	¾	820/1330/835	151		TFD		20.4		118	50.2	
MC-V6-ZB76KE	29.1	15.8	2	800	1 ⅜	¾	820/1330/835	168		TFD		20.4		118	54.7	
MC-V9-ZB92KE	35.6	15.8	2	470	1 ⅜	¾	820/1330/835	200		TWD		25.1		167	54.7	
MC-V6-ZB92KE	35.6	15.8	2	800	1 ⅜	¾	820/1330/835	218		TWD		25.1		167	57.4	
MC-V9-ZB95KE	36.4	15.8	2	470	1 ⅜	¾	820/1330/835	155		TFD		28.2		140	50.7	
MC-V6-ZB95KE	36.4	15.8	2	800	1 ⅜	¾	820/1330/835	172		TFD		28.2		140	54.7	
MC-V6-ZB11ME	42.8	15.8	2	800	1 ⅜	¾	820/1330/835	227		TWD		29.2		198	57.4	
MC-W9-ZB11ME	42.8	15.8	2	800	1 ⅜	¾	820/1330/835	227		TWD		29.2		198	57.4	
MC-V6-ZB114KE	43.3	15.8	2	800	1 ⅜	¾	820/1330/835	174		TFD		33.3		174	54.7	
MC-W9-ZB114KE	43.3	15.8	2	800	1 ⅜	¾	820/1640/864	174		TFD		33.3		174	54.7	
Digital Medium Temperature Models																
MC-M8-ZBD30	11.7	11.7	1	235	¾	⅝	730/735/708	86.5		TFD		7.9		0	48.6	
MC-M9-ZBD45	17.1	11.7	1	400	¾	⅝	730/735/708	95.5		TFD		12.1		0	49.4	
MC-V6-ZBDT60	23.4	18.9	2	800	1 ⅜	¾	820/1330/835	207		TFD		7.9		0	57.4	
MC-V6-ZBDT90	34.1	18.9	2	800	1 ⅜	¾	820/1330/835	218		TFD		12.1		0	57.4	

Conditions EN13215: R404A, Evaporating Temperature MT -10°C/ LT -35°C, Ambient Temperature 32°C, Suction Gas Return 20°C

Technical Overview

Models	Receiver Capacity (l)	Number of fans	Total Fan Motor Power (W)	Suction Line Diameter (inch)	Liquid Line Diameter (inch)	Width/Depth/Height (mm)	Net Weight (kg)	Motor Version/Code		Maximum Operating Current, A		Locked Rotor Current, A		Sound Pressure
								1 Ph*	3 Ph**	1 Ph*	3 Ph**	1 Ph*	3 Ph**	@ 10 m - d(BA)***
Low Temperature Models														
MC-B8-ZF06KE	3.3	1	85	7/8	1/2	560/570/396	64		TFD		5		26	47
MC-D8-ZF09KE	3.9	1	110	7/8	1/2	560/570/446	64		TFD		6		40	47
MC-H8-ZF09KE	7.9	1	235	7/8	1/2	735/680/533	66		TFD		6		40	49
MC-H8-ZF11KE	7.9	1	235	7/8	1/2	735/680/533	67		TFD		7		46	49
MC-H8-ZF13KE	7.9	1	235	7/8	1/2	735/680/533	77		TFD		8		52	50
MC-M8-ZF13KE	7.9	1	235	7/8	1/2	735/730/708	85		TFD		8		52	49
MC-H8-ZF15KE	7.9	1	235	7/8	1/2	735/680/533	83		TFD		10		64	50
MC-M8-ZF15KE	7.9	1	235	7/8	1/2	735/730/708	86		TFD		10		64	50
MC-M8-ZF18KE	7.9	1	235	7/8	1/2	735/730/708	88		TFD		13		74	50
MC-M9-ZF18KE	7.9	1	400	7/8	1/2	735/730/708	96		TFD		13		74	50
MC-P8-ZF24KE	7.9	2	220	1 3/8	1/2	950/640/633	146		TWD		16		99	52
MC-S9-ZF24KE	11.7	2	470	1 3/8	1/2	1130/820/708	170		TWD		16		99	54
MC-R7-ZF33KE	11.7	2	470	1 3/8	5/8	1130/820/633	160		TWD		22		127	55
MC-V9-ZF33KE	11.7	2	470	1 3/8	5/8	1330/820/835	195		TWD		22		127	55
MC-S9-ZF40KE	11.7	2	470	1 3/8	5/8	1130/820/708	180		TWD		25		167	55
MC-V6-ZF40KE	11.7	2	800	1 3/8	5/8	1330/820/835	218		TWD		25		167	57
MC-S9-ZF48KE	11.7	2	470	1 3/8	5/8	1130/820/708	189		TWD		29		198	55

Conditions EN13215: R404A, Evaporating Temperature MT -10°C/ LT -35°C, Ambient Temperature 32°C, Suction Gas Return 20°C

* 1 Ph: 230V/ 50Hz

** 3 Ph: 380-420V/ 50Hz

*** @ 10m: sound pressure level at 10m distance from the compressor, free field condition

Capacity Data

Ambient Temperature: 32°C																	
R134a		Cooling Capacity (kW)						R134a		Power Input (kW)							
		Evaporating Temperature (°C)								Evaporating Temperature (°C)							
Model		-45	-35	-30	-20	-10	-5	+5	Model		-45	-35	-30	-20	-10	-5	+5
MC-D8-ZB15KE					1.4	2.2	2.7	3.9	MC-D8-ZB15KE					1.0	1.0	1.1	1.2
MC-D8-ZB15KE					1.4	2.2	2.7	3.9	MC-D8-ZB15KE					1.0	1.0	1.1	1.2
MC-H8-ZB15KE					1.4	2.3	2.8	4.1	MC-H8-ZB15KE					1.1	1.1	1.1	1.2
MC-D8-ZB19KE					1.6	2.5	3.1	4.4	MC-D8-ZB19KE					1.1	1.2	1.3	1.4
MC-D8-ZB19KE					1.6	2.5	3.1	4.4	MC-D8-ZB19KE					1.1	1.2	1.3	1.4
MC-H8-ZB19KE					1.6	2.6	3.2	4.7	MC-H8-ZB19KE					1.2	1.2	1.3	1.3
MC-K9-ZB19KE					1.6	2.6	3.2	4.7	MC-K9-ZB19KE					1.2	1.3	1.3	1.4
MC-D8-ZB21KE					1.9	3.1	3.7	5.3	MC-D8-ZB21KE					1.4	1.5	1.6	1.7
MC-H8-ZB21KE					2.1	3.2	4.0	5.7	MC-H8-ZB21KE					1.4	1.5	1.6	1.8
MC-K9-ZB21KE					2.1	3.2	4.0	5.8	MC-K9-ZB21KE					1.5	1.5	1.6	1.7
MC-H8-ZB26KE					2.3	3.7	4.5	6.5	MC-H8-ZB26KE					1.6	1.7	1.8	1.9
MC-K9-ZB26KE					2.4	3.7	4.5	6.5	MC-K9-ZB26KE					1.7	1.8	1.8	2.0
MC-H8-ZB30KE					2.6	4.2	5.2	7.4	MC-H8-ZB30KE					1.8	1.9	2.0	2.1
MC-M8-ZB30KE					2.8	4.4	5.3	7.7	MC-M8-ZB30KE					1.9	2.0	2.0	2.2
MC-P8-ZB30KE					2.8	4.4	5.4	7.8	MC-P8-ZB30KE					1.9	2.0	2.1	2.3
MC-H8-ZB38KE					3.0	5.1	6.3	8.9	MC-H8-ZB38KE					2.2	2.4	2.5	2.7
MC-M8-ZB38KE					3.1	5.3	6.5	9.3	MC-M8-ZB38KE					2.2	2.4	2.5	2.8
MC-P8-ZB38KE					3.3	5.4	6.6	9.5	MC-P8-ZB38KE					2.3	2.6	2.7	3.0
MC-M8-ZB45KE					3.8	6.2	7.6	10.9	MC-M8-ZB45KE					2.6	2.9	3.0	3.3
MC-M9-ZB45KE					3.9	6.4	7.8	11.3	MC-M9-ZB45KE					2.7	2.9	3.0	3.3
MC-R7-ZB45KE					4.2	6.5	8.0	11.6	MC-R7-ZB45KE					2.8	2.9	3.0	3.2
MC-S9-ZB50KE					4.8	7.5	9.1	13.1	MC-S9-ZB50KE					3.5	3.8	4.0	4.2
MC-R7-ZB58KE					5.2	8.1	9.9	14.1	MC-R7-ZB58KE					3.7	3.8	4.0	4.3
MC-S9-ZB58KE					5.3	8.3	10.2	14.6	MC-S9-ZB58KE					3.8	4.0	4.1	4.5
MC-S9-ZB66KE					6.1	9.4	11.4	16.4	MC-S9-ZB66KE					4.0	4.2	4.4	4.7
MC-V9-ZB66KE					6.2	9.5	11.6	16.7	MC-V9-ZB66KE					4.1	4.3	4.5	4.9
MC-V9-ZB76KE					7.0	10.8	13.1	18.8	MC-V9-ZB76KE					4.2	4.6	4.8	5.3
MC-V6-ZB76KE					7.1	11.1	13.6	19.6	MC-V6-ZB76KE					4.9	5.0	5.2	5.6
MC-V9-ZB95KE					8.3	13.3	16.2	22.9	MC-V9-ZB95KE					5.9	6.3	6.5	7.1
MC-V6-ZB95KE					8.6	13.8	16.9	24.2	MC-V6-ZB95KE					5.9	6.4	6.7	7.4
MC-V6-ZB114KE					9.9	16.1	19.8	28.4	MC-V6-ZB114KE					7.1	7.6	7.9	8.6
MC-W9-ZB114KE					16.7	19.9	28.7		MC-W9-ZB114KE					7.2	7.6	8.0	8.7

Conditions: EN13215: Suction Gas Return 20°C, Subcooling 0K

Capacity Data

Ambient Temperature: 32°C															
R407A	Cooling Capacity (kW)							R407A	Power Input (kW)						
	Evaporating Temperature (°C)								Evaporating Temperature (°C)						
Model	-45	-35	-30	-20	-10	-5	+5	Model	-45	-35	-30	-20	-10	-5	+5
Medium Temperature Models															
MC-D8-ZB15KE					3.2	3.8	5.3	MC-D8-ZB15KE					1.8	1.9	2.1
MC-H8-ZB15KE**					3.5	4.2	5.9	MC-H8-ZB15KE**					1.7	1.8	1.9
MC-D8-ZB19KE					3.7*	4.5	6.1	MC-D8-ZB19KE					2.2*	2.3	2.5
MC-H8-ZB19KE**					4.1	4.9	6.9	MC-H8-ZB19KE**					2.1	2.2	2.3
MC-K9-ZB19KE**					4.1	4.9	6.8	MC-K9-ZB19KE**					2.1	2.1	2.3
MC-D8-ZB21KE					4.2*	5.1		MC-D8-ZB21KE					2.8*	3.0	
MC-H8-ZB21KE**					4.9	5.8	8.0	MC-H8-ZB21KE**					2.6	2.7	2.8
MC-K9-ZB21KE**					4.8	5.8	7.9	MC-K9-ZB21KE**					2.6	2.7	2.8
MC-H8-ZB26KE					5.4	6.4	8.9	MC-H8-ZB26KE					2.9	3.0	3.4
MC-K9-ZB26KE**					5.4	6.4	8.8	MC-K9-ZB26KE**					2.9	3.0	3.4
MC-H8-ZB30KE					6.3*	7.7		MC-H8-ZB30KE					3.5*	3.8	
MC-M8-ZB30KE**					6.8	8.1	11.1	MC-M8-ZB30KE**					3.3	3.5	3.9
MC-P8-ZB30KE**					6.8	8.2	11.3	MC-P8-ZB30KE**					3.3	3.4	3.8
MC-H8-ZB38KE					7.2*	8.6*		MC-H8-ZB38KE					4.5*	4.9*	
MC-M8-ZB38KE**					7.7*	9.5		MC-M8-ZB38KE**					4.2*	4.5	
MC-P8-ZB38KE**					7.8*	9.6	13.0	MC-P8-ZB38KE**					4.1*	4.4	5.0
MC-M8-ZB42KE				5.56*	8.2*	10.0	13.4	MC-M8-ZB42KE				4.6*	5.1*	5.5	6.0
MC-R7-ZB42KE**				6.0*	9.3	11.1	15.3	MC-R7-ZB42KE**				4.4*	4.8	5.0	5.3
MC-M8-ZB45KE					8.5*	10.3		MC-M8-ZB45KE					5.2*	5.6	
MC-M9-ZB45KE**					9.3	11.0	14.9	MC-M9-ZB45KE**					5.1	5.3	5.8
MC-R7-ZB45KE**					9.6	11.5	15.7	MC-R7-ZB45KE**					4.9	5.1	5.5
MC-R7-ZB50KE**					11.7*	14.6		MC-R7-ZB50KE**					6.9*	7.5	
MC-S9-ZB50KE**					12.7	15.3	21.5	MC-S9-ZB50KE**					6.7	7.1	7.8
MC-R7-ZB58KE					11.1*	13.8		MC-R7-ZB58KE					6.6*	7.1	
MC-S9-ZB58KE**					11.9	14.5	20.4	MC-S9-ZB58KE**					6.3	6.7	7.4
MC-S9-ZB66KE**					13.2	15.9	21.9	MC-S9-ZB66KE**					7.3	7.7	8.7
MC-V9-ZB66KE**					13.8	16.7	23.2	MC-V9-ZB66KE**					6.9	7.3	8.1
MC-V9-ZB76KE					15.8	19.0	26.3	MC-V9-ZB76KE					8.2	8.7	9.8
MC-V6-ZB76KE**					16.7	20.2	28.4	MC-V6-ZB76KE**					8.0	8.4	9.2
MC-V9-ZB95KE					17.4*	21.5		MC-V9-ZB95KE					11.3*	12.1	
MC-V6-ZB95KE**					19.5	23.5	32.6	MC-V6-ZB95KE**					10.7	11.3	12.6
MC-V6-ZB114KE					21.4*	26.8		MC-V6-ZB114KE					13.0*	13.9	
MC-W9-ZB114KE**					22.5	27.4	38.4	MC-W9-ZB114KE**					12.9	13.6	15.4
Medium Temperature Digital Models															
MC-M8-ZBD30					6,8	8,1	11,1	MC-M8-ZBD30					3,4	3,6	4,0
MC-M9-ZBD45					9,2	11,0	15,0	MC-M9-ZBD45					4,9	5,2	5,8
MC-V6-ZBDT60				9,4	14,4	17,4	24,3	MC-V6-ZBDT60				6,0	6,4	6,7	7,3
MC-V6-ZBDT90				12,7	19,1	22,8	31,4	MC-V6-ZBDT90				8,8	9,5	9,9	10,9

Conditions: EN13215: Suction Gas Return 20°C, Subcooling 0K

* Suction Superheat 10 K

** Models for high ambient temperatures

Preliminary Data

Ambient Temperature: 32°C															
R407A	Cooling Capacity (kW)							R407A	Power Input (kW)						
	Evaporating Temperature (°C)								Evaporating Temperature (°C)						
Model	-45	-35	-30	-20	-10	-5	+5	Model	-45	-35	-30	-20	-10	-5	+5
Low Temperature Models															
MC-D8-ZF09KE		1,9	2,3	3,4				MC-D8-ZF09KE		1,9	2,1	2,9			
MC-H8-ZF09KE**		1,9	2,3	3,5	4,9	5,8	7,7	MC-H8-ZF09KE**		1,8	2,1	2,7	3,6	4,2	5,8
MC-H8-ZF11KE		2,1	2,7	4,0	5,7	6,7	9,0	MC-H8-ZF11KE		2,0	2,1	2,4	2,8	3,0	3,5
MC-H8-ZF13KE		2,2	2,8	4,3	6,1	7,1	8,9	MC-H8-ZF13KE		2,3	2,4	2,8	3,1	3,3	3,6
MC-M8-ZF13KE**		2,2	2,8	4,4	6,3	7,3	9,2	MC-M8-ZF13KE**		2,2	2,3	2,6	2,9	3,1	3,3
MC-M9-ZF13KE**		2,2	2,9	4,5	6,5	7,5	9,5	MC-M9-ZF13KE**		2,3	2,4	2,7	3,0	3,1	3,2
MC-H8-ZF15KE		2,7	3,3	5,1	7,3	8,5		MC-H8-ZF15KE		2,8	3,0	3,6	4,1	4,3	
MC-M8-ZF15KE**		2,8	3,4	5,3	7,6	8,9	11,6	MC-M8-ZF15KE**		2,7	2,9	3,4	3,8	3,9	3,8
MC-R7-ZF15KE**		2,8	3,5	5,5	8,0	9,4	12,3	MC-R7-ZF15KE**		2,8	3,0	3,3	3,6	3,7	3,6
MC-M8-ZF18KE		3,3	4,1	6,2	8,8	10,2	13,0	MC-M8-ZF18KE		3,2	3,5	4,2	4,7	4,9	4,5
MC-M9-ZF18KE**		3,3	4,1	6,4	9,1	10,6	13,7	MC-M9-ZF18KE**		3,3	3,5	4,1	4,6	4,6	4,2
MC-S9-ZF18KE**		3,4	4,2	6,6	9,5	11,2	14,5	MC-S9-ZF18KE**		3,2	3,4	3,9	4,3	4,3	3,7
MC-P8-ZF24KE		4,2	5,2	7,8	10,8	12,5		MC-P8-ZF24KE		4,5	4,9	5,7	6,6	7,1	
MC-S9-ZF24KE**		4,4	5,5	8,5	12,2	14,5	19,5	MC-S9-ZF24KE**		4,4	4,7	5,3	6,0	6,4	7,3
MC-R7-ZF33KE		5,9	7,3	10,9	15,3	17,7		MC-R7-ZF33KE		6,0	6,5	7,5	8,8	9,5	
MC-V9-ZF33KE**		6,1	7,7	11,6	16,7	19,7	26,3	MC-V9-ZF33KE**		5,7	6,1	7,0	8,0	8,6	9,9
MC-S9-ZF40KE		7,2	9,0	13,3	18,6	21,5		MC-S9-ZF40KE		7,5	8,1	9,5	11,1	11,9	
MC-V6-ZF40KE**		7,5	9,5	14,4	20,8	24,5	32,9	MC-V6-ZF40KE**		7,3	7,8	8,9	10,2	10,8	12,4
MC-S9-ZF48KE		8,5	10,6	15,4	20,9			MC-S9-ZF48KE		10,1	10,9	12,9	15,2		

Conditions: EN13215: Suction Gas Return 20°C, Subcooling 0K

* Suction Superheat 10 K

** Models for high ambient temperatures

Preliminary Data

Capacity Data

Ambient Temperature: 32°C																	
R407F	Cooling Capacity (kW)							R407F	Power Input (kW)								
	Evaporating Temperature (°C)								Evaporating Temperature (°C)								
Model	-45	-35	-30	-20	-10	-5	+5	Model	-45	-35	-30	-20	-10	-5	+5		
Medium Temperature Models																	
MC-D8-ZB15KE					3.0	3.7	5.0	MC-D8-ZB15KE					2.0	2.0	2.2		
MC-H8-ZB15KE**					3.4	4.1	5.7	MC-H8-ZB15KE**					1.8	1.9	1.9		
MC-D8-ZB19KE					3.5*	4.3	5.9	MC-D8-ZB19KE					2.4*	2.5	2.8		
MC-H8-ZB19KE**					4.0	4.8	6.7	MC-H8-ZB19KE**					2.2	2.3	2.5		
MC-K9-ZB19KE**					4.0	4.8	6.7	MC-K9-ZB19KE**					2.2	2.3	2.5		
MC-D8-ZB21KE					3.9*	4.7*		MC-D8-ZB21KE					3.0*	3.2*			
MC-H8-ZB21KE**					3.9*	4.7*		MC-H8-ZB21KE**					3.0*	3.2*			
MC-K9-ZB21KE**					4.7	5.6	7.7	MC-K9-ZB21KE**					2.7	2.9	3.1		
MC-H8-ZB26KE					5.1*	6.3	8.6	MC-H8-ZB26KE					3.3*	3.5	3.9		
MC-K9-ZB26KE**					5.1*	6.3	8.6	MC-K9-ZB26KE**					3.3*	3.5	3.9		
MC-H8-ZB30KE					6.1*	7.5		MC-H8-ZB30KE					3.8*	4.0			
MC-M8-ZB30KE**					4.0*	6.6	8.0	11.2	MC-M8-ZB30KE**				3.3*	3.5	3.7	4.1	
MC-P8-ZB30KE**					4.1*	6.7	8.0	11.3	MC-P8-ZB30KE**				3.2*	3.5	3.6	4.0	
MC-H8-ZB38KE					7.0*	8.4*		MC-H8-ZB38KE					5.0*	5.3*			
MC-M8-ZB38KE**					7.6*	9.3		MC-M8-ZB38KE**					4.7*	4.9			
MC-P8-ZB38KE**					7.7*	9.4		MC-P8-ZB38KE**					4.6*	4.9			
MC-M8-ZB45KE					8.4*	10.2*		MC-M8-ZB45KE					5.6*	6.0*			
MC-M9-ZB45KE**					9.1*	11.2	15.5	MC-M9-ZB45KE**					5.4*	5.7	6.4		
MC-R7-ZB45KE**					5.9*	9.7	11.8	16.4	MC-R7-ZB45KE**				4.7*	5.2	5.5	6.0	
MC-R7-ZB58KE					11.7*	14.6		MC-R7-ZB58KE					7.1*	7.6			
MC-S9-ZB58KE**					7.1*	12.4*	15.4	21.5	MC-S9-ZB58KE**				6.0*	6.7*	7.2	8.1	
MC-S9-ZB66KE**					13.6*	16.8		MC-S9-ZB66KE**					7.7*	8.3			
MC-V9-ZB66KE**					8.7*	14.6	17.7	24.6	MC-V9-ZB66KE**				6.6*	7.4	7.8	8.7	
MC-V9-ZB76KE					9.8*	16.3*	20.1	27.8	MC-V9-ZB76KE				7.6*	8.7*	9.4	10.7	
MC-V6-ZB76KE**					10.6*	17.8	21.6	30.2	MC-V6-ZB76KE**				7.61*	8.5	8.9	9.9	
MC-V9-ZB95KE					18.2*	22.2*		MC-V9-ZB95KE					11.9*	12.9*			
MC-V6-ZB95KE**					11.8*	20.2*	25.1	34.8	MC-V6-ZB95KE**				10.0*	11.3*	12.0	13.6	
MC-V6-ZB114KE					22.6*	28.2		MC-V6-ZB114KE					14.0*	15.1			
MC-W9-ZB114KE**					13.3*	23.2*	29.0	MC-W9-ZB114KE**					12.1*	13.7*	14.7		
Medium Temperature Digital Models																	
MC-M8-ZBD30					4.6*	6.8	8.1	10.9	MC-M8-ZBD30					2.8*	3.3	3.6	4.1
MC-M9-ZBD45					9.4*	11.6	15.5		MC-M9-ZBD45					5.1*	5.5	6.6	
MC-V6-ZBDT60					9.1*	14.3	17.2	24.0	MC-V6-ZBDT60					6.1*	6.7	6.9	7.6
MC-V6-ZBDT90					12.1*	19.7	23.7	32.6	MC-V6-ZBDT90					8.7*	10.1	10.7	12.2
Low Temperature Models																	
MC-B8-ZF06KE**		1.2	1.4	2.1					MC-B8-ZF06KE**		1.5	1.6	1.8				
MC-D8-ZF09KE		1.7	2.1	3.1	4.4	5.2			MC-D8-ZF09KE		1.8	1.8	2.0	2.3	2.5		
MC-H8-ZF09KE**		1.7	2.2	3.3	4.9	5.8	7.9		MC-H8-ZF09KE**		1.8	1.8	1.9	2.2	2.4	2.8	
MC-H8-ZF11KE		2.2	2.7	4.1	5.9	6.9	9.3		MC-H8-ZF11KE		2.1	2.2	2.4	2.7	3.0	3.5	
MC-M8-ZF13KE**		2.4	3.0	4.6	6.8	8.1	11.0		MC-M8-ZF13KE**		2.5	2.6	2.9	3.4	3.7	4.5	
MC-M9-ZF13KE**		2.4	3.1	4.7	7.0	8.3	11.6		MC-M9-ZF13KE**		2.6	2.7	3.0	3.3	3.6	4.3	
MC-H8-ZF13KE		2.4	3.0	4.5	6.5	7.7			MC-H8-ZF13KE		2.6	2.8	3.1	3.6	4.0		
MC-H8-ZF15KE		2.8	3.6	5.3	7.5				MC-H8-ZF15KE		3.2	3.5	4.1	5.0			
MC-M8-ZF15KE**		2.9	3.7	5.5	8.0	9.4			MC-M8-ZF15KE**		3.0	3.3	3.8	4.5	5.0		
MC-R7-ZF15KE**		3.0	3.8	5.8	8.5	10.2	14.0		MC-R7-ZF15KE**		3.1	3.3	3.7	4.2	4.6	5.6	
MC-M8-ZF18KE		3.5	4.3	6.5	9.2	10.8			MC-M8-ZF18KE		3.8	4.1	4.7	5.5	6.0		
MC-M9-ZF18KE**		3.5	4.5	6.8	9.7	11.5			MC-M9-ZF18KE**		3.8	4.0	4.6	5.2	5.7		
MC-S9-ZF18KE**		3.6	4.6	7.1	10.4	12.3	17.0		MC-S9-ZF18KE**		3.7	3.9	4.3	4.9	5.2	6.1	

Conditions: EN13215: Suction Gas Return 20°C, Subcooling 0K * Suction Superheat 10K ** Models for high ambient temperatures K Preliminary Data

Capacity Data

Ambient Temperature: 32°C															
R404A	Cooling Capacity (kW)							R404A	Power Input (kW)						
	Evaporating Temperature (°C)								Evaporating Temperature (°C)						
	-45	-35	-30	-20	-10	-5	+5		-45	-35	-30	-20	-10	-5	+5
Medium Temperature Models															
MC-D8-ZB15KE			1.2*	2.2	3.3	3.8	5.0	MC-D8-ZB15KE			1.8*	1.9	2.0	2.0	
MC-H8-ZB15KE**			1.5	2.5	3.6	4.3	5.8	MC-H8-ZB15KE**			1.8	1.9	1.9	1.9	1.9
MC-D8-ZB19KE			1.7*	2.8	3.9	4.5	5.8	MC-D8-ZB19KE			2.1*	2.3	2.4	2.5	2.7
MC-H8-ZB19KE**			2.0	3.1	4.3	5.1	6.8	MC-H8-ZB19KE**			2.1	2.1	2.2	2.3	2.4
MC-K9-ZB19KE**			2.1	3.1	4.3	5.1	6.8	MC-K9-ZB19KE**			2.0	2.1	2.2	2.3	2.4
MC-D8-ZB21KE			1.9*	3.2	4.4	5.0	6.4	MC-D8-ZB21KE			2.5*	2.8	3.1	3.2	3.5
MC-H8-ZB21KE**			2.4	3.6	5.1	5.9	7.8	MC-H8-ZB21KE**			2.5	2.6	2.7	2.8	3.0
MC-K9-ZB21KE**			2.4	3.6	5.1	5.9	7.8	MC-K9-ZB21KE**			2.4	2.6	2.7	2.8	3.0
MC-H8-ZB26KE			2.4*	4.1	5.7	6.6	8.6	MC-H8-ZB26KE			2.9*	3.1	3.3	3.4	3.7
MC-K9-ZB26KE**			2.4*	4.1	5.7	6.6	8.7	MC-K9-ZB26KE**			2.9*	3.1	3.3	3.4	3.6
MC-H8-ZB30KE		2.1*	2.7	4.6	6.4	7.4	9.6	MC-H8-ZB30KE		3.3*	3.4	3.7	3.9	4.1	4.4
MC-M8-ZB30KE**		2.2*	3.2	4.8	6.8	7.9	10.5	MC-M8-ZB30KE**		3.1*	3.3	3.4	3.6	3.7	4.0
MC-P8-ZB30KE**		2.3*	3.3	5.0	7.1	8.3	11.1	MC-P8-ZB30KE**		3.1*	3.2	3.3	3.5	3.5	3.8
MC-H8-ZB38KE		2.5*	3.2	5.3	7.3	8.4	10.7	MC-H8-ZB38KE		4.2*	4.3	4.8	5.2	5.4	6.0
MC-M8-ZB38KE**		2.7*	3.4	5.7	8.0	9.2	12.0	MC-M8-ZB38KE**		4.0*	4.1	4.4	4.8	5.0	5.4
MC-P8-ZB38KE**		2.7*	3.4	5.7	8.0	9.2	12.0	MC-P8-ZB38KE**		4.0*	4.1	4.4	4.8	5.0	5.4
MC-M8-ZB45KE		3.0*	3.9	6.5	8.9	10.3	13.2	MC-M8-ZB45KE		4.6*	4.8	5.3	5.7	6.0	6.5
MC-M9-ZB45KE**		3.2*	4.1	6.9	9.6	11.1	14.5	MC-M9-ZB45KE**		4.6*	4.8	5.1	5.5	5.7	6.1
MC-R7-ZB45KE**		3.3*	4.8	7.1	10.1	11.8	15.6	MC-R7-ZB45KE**		4.6*	4.7	5.0	5.3	5.4	5.8
MC-R7-ZB50KE			3.1*	7.5	11.4	13.4	17.7	MC-R7-ZB50KE			5.5*	6.0	6.5	6.7	7.2
MC-S9-ZB50KE**			3.3*	7.9	12.0	14.2	18.9	MC-S9-ZB50KE**			5.3*	5.8	6.1	6.3	6.7
MC-R7-ZB58KE			4.1*	8.5	12.4	14.5	18.8	MC-R7-ZB58KE			6.1*	6.7	7.3	7.6	8.3
MC-S9-ZB58KE**			4.4*	8.9	13.1	15.4	20.3	MC-S9-ZB58KE**			5.9*	6.4	6.9	7.1	7.7
MC-S9-ZB66KE			6.0*	10.3	14.5	16.8	21.7	MC-S9-ZB66KE			6.6*	7.4	7.9	8.2	8.9
MC-V9-ZB66KE**			6.2*	10.7	15.1	17.6	23.0	MC-V9-ZB66KE**			6.5*	7.1	7.6	7.8	8.5
MC-V9-ZB76KE			6.9*	12.2	17.2	19.9	25.8	MC-V9-ZB76KE			7.5*	8.3	9.0	9.4	10.3
MC-V6-ZB76KE**			7.4*	12.9	18.5	21.6	28.7	MC-V6-ZB76KE**			7.4*	8.0	8.6	8.9	9.6
MC-V9-ZB95KE				12.2*	19.3	22.3	28.7	MC-V9-ZB95KE				11.2*	12.4	13.0	14.3
MC-V6-ZB95KE**			7.8*	14.9	21.5	25.2	33.1	MC-V6-ZB95KE**			10.2*	10.7	11.4	11.9	13.0
MC-V6-ZB114KE			8.4*	16.6	24.3	28.4	37.3	MC-V6-ZB114KE			12.5*	13.3	14.3	14.8	16.2
MC-W9-ZB114KE**			8.5*	16.8	24.6	28.8	38.0	MC-W9-ZB114KE**			12.4*	13.2	14.1	14.7	16.0
Digital Medium Temperature Models															
MC-M8-ZBD30KE			3.0*	5.0	6.9	8.0	10.5	MC-M8-ZBD30KE			2.5*	3.0	3.4	3.6	4.0
MC-M9-ZBD45KE			3.7*	6.7	9.9	11.8	16.1	MC-M9-ZBD45KE			4.4*	4.9	5.5	5.8	6.7
MC-V6-ZBDT60KE			7.0	10.4	14.9	17.6	23.6	MC-V6-ZBDT60KE			5.8	6.3	6.7	7.0	7.5
MC-V6-ZBDT90KE			8.0*	14.1	20.4	24.1	32.5	MC-V6-ZBDT90KE			8.8*	9.6	10.4	10.8	11.9

Conditions: EN13215: Suction Gas Return 20°C, Subcooling 0K

* Conditions: EN13215: Suction Superheat 10K

** Models for high ambient temperatures

Capacity Data

Ambient Temperature: 32°C															
R407C		Cooling Capacity (kW)						R407C		Power Input (kW)					
		Evaporating Temperature (°C)								Evaporating Temperature (°C)					
Model	-45	-35	-30	-20	-10	-5	+5	Model	-45	-35	-30	-20	-10	-5	+5
MC-V6-ZB11ME				14.5*	21.5*	26,2	35,8	MC-V6-ZB11ME				10.7*	11.8*	12,7	14,1
MC-W9-ZB11ME				14.7*	21.9*	26,6	36,5	MC-W9-ZB11ME				10.5*	11.7*	12,4	13,7
MC-D8-ZB15KE				1.8*	3,0	3,6	5,1	MC-D8-ZB15KE				1.6*	1,6	1,7	1,8
MC-H8-ZB15KE**				1.9*	3,2	3,9	5,6	MC-H8-ZB15KE**				1.6*	1,6	1,6	1,7
MC-D8-ZB19KE				2.0*	3.2*	4,0	5,7	MC-D8-ZB19KE				1.7*	1.9*	2,0	2,2
MC-H8-ZB19KE**				2.2*	3,5	4,3	6,3	MC-H8-ZB19KE**				1.7*	1,8	1,9	2,0
MC-K9-ZB19KE**				2.2*	3,5	4,3	6,3	MC-K9-ZB19KE**				1.7*	1,8	1,9	2,0
MC-D8-ZB21KE				2.6*	4.0*	4.9*	6,8	MC-D8-ZB21KE				2.2*	2.5*	2.6*	3,0
MC-H8-ZB21KE**				2.9*	4,6	5,5	7,8	MC-H8-ZB21KE**				2.1*	2,3	2,4	2,6
MC-K9-ZB21KE**				2.8*	4,6	5,5	7,7	MC-K9-ZB21KE**				2.1*	2,3	2,4	2,6
MC-D8-ZR22KE				1.6*	2.6*	3.2*	4.7*	MC-D8-ZR22KE				1.3*	1.4*	1.5*	1.6*
MC-H8-ZR22KE**				1.7*	2.7*	3.4*	5.0*	MC-H8-ZR22KE**				1.4*	1.4*	1.4*	1.5*
MC-H8-ZB26KE				3.3*	5.1*	6,3	8,8	MC-H8-ZB26KE				2.5*	2.7*	2,9	3,2
MC-K9-ZB26KE**				3.3*	5.1*	6,2	8,7	MC-K9-ZB26KE**				2.5*	2.7*	2,9	3,2
MC-H8-ZB30KE				4.0*	5.9*	7,1	9,7	MC-H8-ZB30KE				3.0*	3.4*	3,6	4,0
MC-M8-ZB30KE**				4.2*	6.2*	7,5	10,4	MC-M8-ZB30KE**				2.8*	3.2*	3,3	3,7
MC-P8-ZB30KE**				4.2*	6,3	7,5	10,5	MC-P8-ZB30KE**				2.8*	3,1	3,3	3,6
MC-H8-ZB38KE					7.0*	8.4*	11,4	MC-H8-ZB38KE					4.3*	4.5*	5,3
MC-M8-ZB38KE**				4.9*	7.5*	9,1	12,3	MC-M8-ZB38KE**				3.6*	3.9*	4,2	4,7
MC-P8-ZB38KE**				4.9*	7.5*	9,1	12,5	MC-P8-ZB38KE**				3.6*	3.9*	4,1	4,6
MC-M8-ZB42KE				5.3*	7.9*	9.4*	13,0	MC-M8-ZB42KE				4.5*	4.9*	5.1*	5,6
MC-R7-ZB42KE**				5.7*	8,8	10,5	14,7	MC-R7-ZB42KE**				4.3*	4,6	4,7	4,8
MC-M8-ZB45KE				5.4*	8.2*	9.8*	13,8	MC-M8-ZB45KE				4.3*	4.8*	5.1*	5,9
MC-M9-ZB45KE**				5.6*	8.7*	10,7	14,8	MC-M9-ZB45KE**				4.2*	4.6*	4,9	5,5
MC-R7-ZB45KE**				5.8*	9,1	11,1	15,5	MC-R7-ZB45KE**				4.1*	4,5	4,7	5,1
MC-R7-ZB50KE**				5.7*	10,1	12,3	17,1	MC-R7-ZB50KE**				5.0*	5,5	5,7	6,3
MC-S9-ZB50KE**				6.1*	10,5	12,8	17,8	MC-S9-ZB50KE**				4.8*	5,2	5,4	6,0
MC-R7-ZB56KE				6.8*	10.2*	12,4	17,0	MC-R7-ZB56KE				5.6*	6.1*	6,4	7,0
MC-S9-ZB56KE				7.0*	10,8	12,9	17,8	MC-S9-ZB56KE				5.4*	5,9	6,1	6,6
MC-S9-ZB66KE**					13,3	15,9	22,0	MC-S9-ZB66KE**					6,7	7,1	7,9
MC-V9-ZB66KE**				9.0*	13,8	16,5	23,0	MC-V9-ZB66KE**				5.8*	6,4	6,7	7,3
MC-V6-ZB75KE				10.1*	15,4	18,5	25,7	MC-V6-ZB75KE				6.5*	7,2	7,6	8,3
MC-V9-ZB75KE				9.7*	14.5*	17,7	24,2	MC-V9-ZB75KE				6.5*	7.3*	7,8	8,7
MC-V9-ZB76KE				10.0*	15,6	18,7	26,0	MC-V9-ZB76KE				6.9*	7,7	8,1	9,1
MC-V6-ZB76KE**				10.4*	16,3	19,7	27,6	MC-V6-ZB76KE**				6.9*	7,5	7,7	8,5
MC-R7-ZR81KE				5.7*	9.4*	11.6*	16.4*	MC-R7-ZR81KE				4.5*	5.0*	5.3*	5.9*
MC-S9-ZR81KE				5.9*	9.7*	12.0*	17.2*	MC-S9-ZR81KE				4.4*	4.8*	5.0*	5.5*
MC-V6-ZB92KE				12.2*	18.1*	22,1	30,3	MC-V6-ZB92KE				8.5*	9.4*	9,9	11,0
MC-V9-ZB92KE				11.7*	17.2*	20,8	28,0	MC-V9-ZB92KE				8.7*	9.8*	10,5	11,8
MC-V9-ZB95KE				10.3*	17,3	21,0	29,8	MC-V9-ZB95KE				9.1*	10,3	11,0	12,7
MC-V6-ZB95KE**				11.1*	18,5	22,7	32,7	MC-V6-ZB95KE**				8.8*	9,7	10,2	11,5
MC-W9-ZB114KE**				13.6*	22,2	26,9	37,7	MC-W9-ZB114KE**				10.7*	11,9	12,5	14,0

Conditions: EN13215: Suction Gas Return 20°C, Subcooling 0K

* Suction Superheat 10 K

** Models for high ambient temperatures K

Preliminary Data

Copeland Scroll Digital™ Receiver Unit HLR

Copeland Scroll Digital Receiver Units are the perfect choice for remote condenser systems.

These Scroll Digital Receiver Units are an innovative offering by Emerson Climate Technologies for food service and retail businesses. Their compact design and the power of Digital Scroll continuous capacity modulation allow for optimized environmental integration at highest system efficiency.

Eight models with single or tandem compressors cover the need of medium temperature refrigeration capacities in various applications. The continuous capacity modulation always provides the right performance, especially for systems with multiple evaporators and variable loads. The remote condenser concept allows for optimal building integration.



Digital Receiver Unit HLR



Digital Receiver Unit HLR Line-up

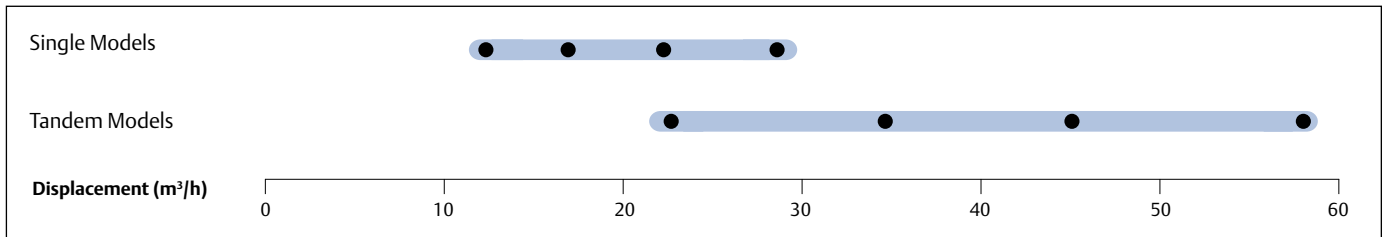

Features and Benefits

- Standard equipment: Digital Scroll compressor, liquid receiver, liquid line with filter drier and sight glass, HP/LP switch, complete electrical box including controller with overload protection and communication interface
- Continuous capacity modulation 10-100 % (Single) or 5-100 % (Tandem)
- Precise suction pressure control
- Maximum system flexibility by free choice of third party condensers
- Excellent energy efficiency
- High reliability
- Easy and quick installation

Maximum Allowable Pressures (PS)

- Low Side PS 22.5 bar (g)
- High Side PS = 28/32 bar (g)

Technical Overview

Models	Displacement (m ³ /h)	Receiver Capacity (l)	Suction Line Diameter (inch)	Liquid Line Diameter (inch)	Width/Depth/Height (mm)	Net Weight (kg)	Motor Version/Code		Maximum Operating Current (A)		Locked Rotor Current (A)		Sound Pressure @1 m dB(A)***	
							1 Ph*	3 Ph**	1 Ph*	3 Ph**	1 Ph*	3 Ph**	with-out sound shell	with sound shell
Single Compressor Unit Models														
HLR13-ZBD30KE	11.7	13	7/8	5/8	690/400/710	72	TFD		8		52		59	49
HLR13-ZBD45KE	17.1	13	7/8	5/8	690/400/710	75	TFD		12		74		61	51
HLR13-ZBD58KE	22.1	13	1 1/8	3/4	725/400/710	84	TFD		15		95		65	55
HLR13-ZBD76KE	28.8	13	1 3/8	3/4	725/400/710	90	TFD		20		118		66	56
Tandem Compressor Unit Models														
HLR31-ZBDT60KE	23.4	31	1 3/8	7/8	970/480/910	130	TFD		8+8		52 + 52		62	-
HLR31-ZBDT90KE	34.1	31	1 3/8	7/8	970/480/910	138	TFD		12 + 12		74 + 74		64	-
HLR31-ZBDT116KE	44.2	31	1 5/8	1 1/8	970/480/870	165	TFD		15 + 15		95 + 95		68	-
HLR31-ZBDT152KE	58.2	31	1 5/8	1 3/8	970/480/870	175	TFD		20 + 20		118 + 118		69	-

Conditions EN12900: R404A, Evaporating Temperature -10°C, Condensing Temperature 45°C, Suction Gas Return 20°C

Capacity Data

Condensing Temperature: 40°C															
R134a	Cooling Capacity (kW)							R134a	Power Input (kW)						
	Evaporating Temperature (°C)								Evaporating Temperature (°C)						
Model	-45	-35	-30	-20	-10	-5	+5	Model	-45	-35	-30	-20	-10	-5	+5
Single Compressor Unit Models															
HLR13-ZBD30KCE					4.3	5.2	7.5	HLR13-ZBD30KCE					1.9	2.0	2.2
HLR13-ZBD45KCE					6.0	7.5	11.2	HLR13-ZBD45KCE					2.7	2.9	3.1
HLR13-ZBD58KCE					7.8	9.7	14.4	HLR13-ZBD58KCE					3.8	3.8	3.9
HLR31-ZBD76KCE					10.2	12.7	18.9	HLR31-ZBD76KCE					4.9	5.0	5.1
Tandem Compressor Unit Models															
HLR31-ZBDT60KCE					8.3	10.3	15.2	HLR31-ZBDT60KCE					3.9	4.0	4.2
HLR31-ZBDT90KCE					12.1	15.1	22.6	HLR31-ZBDT90KCE					5.5	5.6	5.9
HLR31-ZBDT116KCE					15.6	19.4	28.8	HLR31-ZBDT116KCE					7.5	7.6	7.8
HLR31-ZBDT152KCE					20.4	25.3	37.8	HLR31-ZBDT152KCE					9.8	9.9	10.2

Conditions: EN13215: Suction Gas Return 20°C, Subcooling 0K

Preliminary data

Condensing Temperature: 40°C															
R407A	Cooling Capacity (kW)							R407A	Power Input (kW)						
	Evaporating Temperature (°C)								Evaporating Temperature (°C)						
Model	-45	-35	-30	-20	-10	-5	+5	Model	-45	-35	-30	-20	-10	-5	+5
Single Compressor Unit Models															
HLR13-ZBD30KCE				4.0*	6.8	8.4	12.4	HLR13-ZBD30KCE				3.2*	3.1	3.2	3.2
HLR13-ZBD45KCE				5.5*	9.4	11.7	17.2	HLR13-ZBD45KCE				4.4*	4.3	4.4	4.4
Tandem Compressor Unit Models															
HLR31-ZBDT60KCE				8.0*	13.6	16.8	24.6	HLR31-ZBDT60KCE				6.2*	6.2	6.2	6.3
HLR31-ZBDT90KCE				11.4*	18.9	23.2	34.1	HLR31-ZBDT90KCE				8.7*	8.8	8.8	8.8

Conditions: EN13215: Suction Gas Return 20°C, Subcooling 0K

* Suction Superheat 10K

Preliminary data

Capacity Data

Condensing Temperature: 40°C															
R407F	Cooling Capacity (kW)							R407F	Power Input (kW)						
	Evaporating Temperature (°C)								Evaporating Temperature (°C)						
Model	-45	-35	-30	-20	-10	-5	+5	Model	-45	-35	-30	-20	-10	-5	+5
HLR13-ZBD30KCE			2.8*	4.8	7.3	8.8	12.8	HLR13-ZBD30KCE			2.0*	2.5	2.8	2.9	3.1
HLR13-ZBD45KCE				6.4*	10.8	13.2	18.9	HLR13-ZBD45KCE				3.7*	4.1	4.3	4.6
HLR31-ZBDT60KCE				8.9*	14.5	17.7	25.7	HLR31-ZBDT60KCE				5.4*	5.7	5.8	6.0
HLR31-ZBDT90KCE				12.4*	21.2	26.1	37.9	HLR31-ZBDT90KCE				7.8*	8.4	8.5	8.8

Conditions: EN12900: Condensing Temperature 45°C, Suction Gas Return 20°C, Subcooling 0K

* Conditions: EN12900: Condensing Temperature 45°C, Suction Superheat 10K

Condensing Temperature: 45°C															
R404A	Cooling Capacity (kW)							R404A	Power Input (kW)						
	Evaporating Temperature (°C)								Evaporating Temperature (°C)						
	-45	-35	-30	-20	-10	-5	+5		-45	-35	-30	-20	-10	-5	+5
Single Compressor Unit Models															
HLR13-ZBD30KCE			2.7*	4.8	7.0	8.4	11.8	HLR13-ZBD30KCE			2.4*	2.9	3.1	3.2	3.5
HLR13-ZBD45KCE			3.4*	6.6	10.2	12.5	18.0	HLR13-ZBD45KCE			4.4*	4.6	4.8	4.9	5.2
HLR13-ZBD58KCE				8.6	13.5	16.3	22.9	HLR13-ZBD58KCE				6.4	6.4	6.4	6.4
HLR13-ZBD76KCE				11.8	17.9	21.4	30.2	HLR13-ZBD76KCE				8.1	8.3	8.3	8.4
Tandem Compressor Unit Models															
HLR31-ZBDT60KCE			5.4*	9.6	14.1	16.9	23.6	HLR31-ZBDT60KCE			4.9*	5.8	6.3	6.5	6.9
HLR31-ZBDT90KCE			7.0*	13.4	20.3	24.5	35.0	HLR31-ZBDT90KCE			9.2*	9.4	9.6	9.7	9.9
HLR31-ZBDT116KE			6.4*	17.0	26.7	32.4	45.8	HLR31-ZBDT116KE			13.1*	12.7	12.7	12.7	12.8
HLR31-ZBDT152KE				23.7	35.7	42.9	60.3	HLR31-ZBDT152KE				16.2	16.4	16.5	16.8

Conditions: EN12900: Condensing Temperature 45°C, Suction Gas Return 20°C, Subcooling 0K

* Conditions: EN12900: Condensing Temperature 45°C, Suction Superheat 10K

Condensing Temperature: 40°C															
R407C	Cooling Capacity (kW)							R407C	Power Input (kW)						
	Evaporating Temperature (°C)								Evaporating Temperature (°C)						
Model	-45	-35	-30	-20	-10	-5	+5	Model	-45	-35	-30	-20	-10	-5	+5
Single Compressor Unit Models															
HLR13-ZBD30KCE					6.2	7.6	11.1	HLR13-ZBD30KCE					3.0	3.0	3.0
HLR13-ZBD45KCE					8.9	11.1	16.5	HLR13-ZBD45KCE					4.1	4.1	4.2
Tandem Compressor Unit Models															
HLR31-ZBDT60KCE					12.2*	15.2	22.2	HLR31-ZBDT60KCE					6.0*	6.0	6.1
HLR31-ZBDT90KCE					17.5*	22.2	32.9	HLR31-ZBDT90KCE					8.3*	8.3	8.4

Conditions: EN13215: Suction Gas Return 20°C, Subcooling 0K

* Suction Superheat 10K

Semi-Hermetic Condensing Units DK/DL

Copeland™ air-cooled indoor condensing units for medium temperature and low temperature applications.

Long-term engineering and manufacturing experience has led to these condensing units with reed valve technology compressors. Their excellent quality and reliability is traditionally well known in the refrigeration industry.

This series of condensing units is equipped with single fan or twin fans which allows for very compact dimensions. The wide range of models offers solutions for most applications including operation in extreme conditions like high evaporation temperatures and high ambient temperatures.



Semi-Hermetic Condensing Unit DK/DL

Semi-Hermetic K & L Condensing Units Line-up

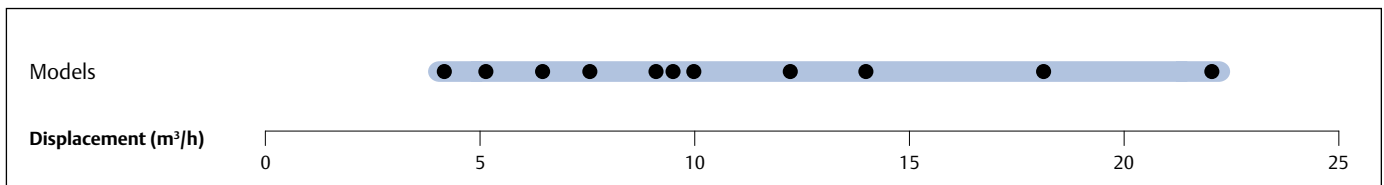

Features and Benefits

- Standard equipment: compressor, condenser with thermally protected fan(s), discharge line with flexible pipe loop or vibration absorber, liquid receiver with shut-off-valve, HP/LP switch with automatic reset
- Suitable for a broad range of refrigerants: R404A, R507, R134a, R407A/C, R22
- Wide range of quality accessories
- Proven reliability

Maximum Allowable Pressures (PS)

- Low Side PS 22.5 bar (g)
- High Side PS = 28 bar (g)

Technical Overview

Models	Displacement (m ³ /h)	Number of fans	Total Fan Motor Power (W)	Suction Line Diameter (inch)	Liquid Line Diameter (inch)	Length/Width/Height (mm)	Net Weight (kg)	Motor Version/Code		Maximum Operating Current, A		Locked Rotor Current, A		Sound Pressure @ 10 m - d(BA)***
								1 Ph*	3 Ph**	1 Ph*	3 Ph**	1 Ph*	3 Ph**	
B8-KM-5X-B		1	85	5/8	1/2	570/560/396	56	CAG	EWL	4.8	1.8	24	12.2	39
B8-KM-7X-B	4.0	1	85	1/2	1/2	570/560/396	57.5		EWL		2.4		12.2	
B8-KJ-7X-B	4.0	1	85	5/8	1/2	570/560/396	57.5	CAG	EWL	5.8	2.3	34.5	12.2	
B8-KJ-10X-B	5.1	1	85	5/8	1/2	570/560/396	57.5	CAG	EWL	7.1	3.2	32.4	15.5	39.4
B8-KSJ-10X-B	6.3	1	85	5/8	1/2	570/560/396	58.5	CAG	EWL	6.7	2.7	32.4	15.5	
B8-KL-15X-B	7.4	1	85	5/8	1/2	570/560/396	57.5	CAG	EWL	8.4	3.4	43	19.1	39.5
D8-KSJ-15X-B	6.3	1	110	7/8	1/2	570/560/446	62	CAG	EWL	9.0	3.4	43	19.1	45.6
D8-KSL-15X-B		1	110	5/8	1/2	570/560/446	60		EWL		3.3		20.4	
D8-KSL-20X-B	9.1	1	110	5/8	1/2	570/560/446	60		EWL		4.7		20.4	
D8-LE-20X-B	9.9	1	110	7/8	1/2	715/560/446	96.5		EWL		5.7		37.6	
D8-LF-20X-B	12.9	1	110	7/8	1/2	715/560/446	98.5		EWL		5.5		37.6	
H8-KSL-20X-B	9.1	1	235	5/8	1/2	680/735/533	60		EWL		4.7		20.4	
H8-LJ-20X-B	9.5	1	235	7/8	1/2	680/735/533	103		EWL		5.6		37.6	
H8-LE-20X-B	9.9	1	235	7/8	1/2	680/735/533	108		EWL		5.7		37.6	
H8-LF-30X-B	12.9	1	235	7/8	1/2	680/735/533	108		EWL		7.2		53	48.5
P8-LF-30X-B	12.9	2	220	1 1/8	1/2	640/950/633	127		EWL		7.2		53	47.8
H8-LJ-30X-B	14.5	1	235	7/8	1/2	680/735/533	108		EWL		8.1		53	48.5
P8-LJ-30X-B	14.5	2	220	7/8	1/2	640/950/633	127		EWL		8.1		53	47.8
H8-LL-30X-B	18.2	1	235	1 1/8	1/2	680/735/533	110		EWL		7.3		50.6	48.5
K9-LL-30X-B	18.2	2	220	1 1/8	1/2	640/950/454	134		EWL		7.3		50.6	47.2
H8-LL-40X-B	18.2	1	235	1 1/8	1/2	680/735/533	112		EWL		9.5		58.9	48.6
P8-LL-40X-B	18.2	2	220	1 1/8	1/2	640/950/633	128		EWL		9.5		58.9	48
H8-LSG-40X-B	22.5	1	235	1 1/8	1/2	680/735/533	116		EWL		8.9		58.9	
K9-LSG-40X-B	22.5	2	220	1 1/8	1/2	640/950/454	131		EWL		8.9		58.9	50.9

* 1 Ph: 230V/ 50Hz

** 3 Ph: 380-420V/ 50Hz

*** @ 10 m: sound pressure level at 10m distance from the compressor, free field condition

Capacity Data

Ambient Temperature +32°C															
R134a		Cooling Capacity (kW)						R134a		Power Input (kW)					
		Evaporating Temperature (°C)								Evaporating Temperature (°C)					
Model	-45	-35	-30	-20	-10	-5	+5	Model	-45	-35	-30	-20	-10	-5	+5
B8-KM-5X-B				0.8	1.2	1.5	2.2	B8-KM-5X-B				0.5	0.6	0.7	0.8
B8-KJ-7X-B				1.0	1.6	1.9	2.8	B8-KJ-7X-B				0.7	0.8	0.9	1.0
B8-KSJ-10X-B				1.2	1.9	2.4	3.4	B8-KSJ-10X-B				0.8	0.9	1.0	1.2
B8-KL-15X-B				1.4	2.2	2.6	3.7	B8-KL-15X-B				0.9	1.2	1.3	1.6
D8-KSL-15X-B				1.8	2.8	3.4	4.9	D8-KSL-15X-B				1.1	1.4	1.6	1.9
D8-KSL-20X-B				1.8	2.9	3.5	5.0	D8-KSL-20X-B				1.1	1.4	1.5	1.8
H8-KSL-20X-B				1.9	3.0	3.7	5.4	H8-KSL-20X-B				1.2	1.5	1.6	1.8
D8-LE-20X-B				1.6	2.7	3.4	4.9	D8-LE-20X-B				1.1	1.4	1.5	1.8
H8-LE-20X-B				1.7	2.9	3.6	5.4	H8-LE-20X-B				1.2	1.5	1.6	1.8
D8-LF-20X-B				2.2	3.6	4.4	6.2	D8-LF-20X-B				1.4	1.7	1.9	2.3
H8-LJ-20X-B				2.7	4.3	5.2	7.5	H8-LJ-20X-B				1.8	2.2	2.4	2.8
H8-LL-30X-B				3.2	5.3	6.5	9.2	H8-LL-30X-B				2.1	2.6	3.0	3.7
K9-LL-30X-B				3.2	5.3	6.5	9.3	K9-LL-30X-B				2.1	2.6	2.9	3.7
H8-LSG-40X-B				4.2	6.6	7.9	11.0	H8-LSG-40X-B				2.5	3.2	3.7	4.6
K9-LSG-40X-B				4.2	6.6	8.0	11.1	K9-LSG-40X-B				2.5	3.2	3.6	4.5

Conditions: EN13215: Suction Gas Return 20°C, Subcooling 0K

Ambient Temperature +32°C															
R407A		Cooling Capacity (kW)						R407A		Power Input (kW)					
		Evaporating Temperature (°C)								Evaporating Temperature (°C)					
Model	-45	-35	-30	-20	-10	-5	+5	Model	-45	-35	-30	-20	-10	-5	+5
B8-KM-5X-B		0.5	0.7	1.2				B8-KM-5X-B		0.5	0.6	0.7			
B8-KM-7X-B		0.5	0.7	1.2	1.8	2.2	3.0	B8-KM-7X-B		0.6	0.6	0.8	0.9	1.0	1.2
B8-KJ-7X-B		0.7	0.9	1.5				B8-KJ-7X-B		0.7	0.8	1.0			
B8-KJ-10X-B		0.7	0.9	1.5	2.3	2.7		B8-KJ-10X-B		0.6	0.7	0.9	1.2	1.4	
B8-KSJ-10X-B		0.9	1.2	1.9				B8-KSJ-10X-B		0.9	1.0	1.3			
D8-KSJ-15X-B		0.9	1.2	2.0	3.0	3.6		D8-KSJ-15X-B		0.9	1.0	1.3	1.5	1.7	
B8-KL-15X-B		1.0	1.3	2.1				B8-KL-15X-B		1.0	1.1	1.4			
D8-LE-20X-B		0.9	1.4	2.6	4.1	5.0		D8-LE-20X-B		0.9	1.1	1.5	2.0	2.2	
H8-LE-20X-B		0.9	1.5	2.8	4.6	5.6	7.9	H8-LE-20X-B		1.0	1.2	1.6	2.1	2.3	2.7
H8-LJ-20X-B		1.6	2.3	4.2				H8-LJ-20X-B		1.5	1.8	2.5			
H8-LF-30X-B		1.3	2.0	3.7	5.9	7.1		H8-LF-30X-B		1.4	1.6	2.2	2.8	3.1	
D8-LF-20X-B		1.3	1.8	3.2				D8-LF-20X-B		1.2	1.5	2.0			
P8-LF-30X-B		1.4	2.1	3.9	6.2	7.5	10.6	P8-LF-30X-B		1.3	1.6	2.2	2.7	3.0	3.6
P8-LJ-30X-B		1.9	2.6	4.5	6.9	8.3		P8-LJ-30X-B		1.7	1.9	2.6	3.2	3.6	
H8-LJ-30X-B		1.8	2.6	4.3	6.6	7.9		H8-LJ-30X-B		1.7	2.0	2.6	3.3	3.7	
H8-LL-30X-B		2.1	3.0	5.2				H8-LL-30X-B		1.8	2.2	3.1			
H8-LL-40X-B		2.1	3.1	5.3	8.0	9.5		H8-LL-40X-B		1.9	2.2	3.1	4.1	4.6	
P8-LL-40X-B		2.2	3.2	5.6	8.6	10.4		P8-LL-40X-B		1.9	2.2	3.1	4.0	4.5	
K9-LSG-40X-B		2.7	3.8	6.3				K9-LSG-40X-B		2.3	2.7	3.8			

Conditions: EN13215: Suction Gas Return 20°C, Subcooling 0K

Capacity Data

Ambient Temperature +32°C															
R404A		Cooling Capacity (kW)						R404A		Power Input (kW)					
		Evaporation Temperature (°C)								Evaporation Temperature (°C)					
Model	-45	-35	-30	-20	-10	-5	+5	Model	-45	-35	-30	-20	-10	-5	+5
B8-KM-5X-B	0.3	0.6	0.8	1.3				B8-KM-5X-B	0.5	0.6	0.6	0.8			
B8-KM-7X-B	0.3	0.6	0.8	1.3	1.9	2.2	3.0	B8-KM-7X-B	0.4	0.6	0.7	0.8	1.0	1.1	1.3
B8-KJ-10X-B	0.4	0.8	1.1	1.7	2.4	2.8	3.6	B8-KJ-10X-B	0.5	0.8	0.9	1.1	1.4	1.5	1.8
B8-KJ-7X-B	0.4	0.8	1.1	1.7				B8-KJ-7X-B	0.6	0.8	0.9	1.1			
B8-KSJ-10X-B	0.6	1.1	1.3	1.8				B8-KSJ-10X-B	0.8	1.0	1.2	1.5			
D8-KSJ-15X-B	0.6	1.1	1.4	2.2	3.2	3.8		D8-KSJ-15X-B	0.7	1.0	1.1	1.4	1.8	1.9	
B8-KL-15X-B	0.7	1.2	1.5	2.3				B8-KL-15X-B	0.9	1.1	1.3	1.6			
D8-KSL-20X-B	0.9	1.6	2.0	3.1	4.3			D8-KSL-20X-B	1.0	1.3	1.5	2.0	2.6		
H8-KSL-20X-B	0.9	1.7	2.2	3.3	4.8	5.7		H8-KSL-20X-B	1.1	1.5	1.7	2.1	2.6	2.8	
D8-LE-20X-B		1.2	1.7	2.9	4.3	5.0		D8-LE-20X-B		1.1	1.3	1.7	2.2	2.5	
H8-LE-20X-B		1.3	1.9	3.2	4.8	5.8	7.8	H8-LE-20X-B		1.2	1.4	1.9	2.3	2.5	3.0
D8-LF-20X-B	0.7	1.7	2.2	3.5				D8-LF-20X-B	1.0	1.5	1.8	2.4			
H8-LF-30X-B	0.9	2.1	2.7	4.4	6.3	7.4		H8-LF-30X-B	1.3	1.9	2.1	2.7	3.3	3.6	
P8-LF-30X-B	1.0	2.1	2.9	4.7	6.9	8.2	11.1	P8-LF-30X-B	1.3	1.9	2.1	2.6	3.2	3.4	4.0
H8-LJ-20X-B	0.8	2.1	2.9					H8-LJ-20X-B	1.2	1.8	2.2				
H8-LJ-30X-B	1.1	2.3	3.0	4.7	6.8	7.9		H8-LJ-30X-B	1.4	2.0	2.4	3.0	3.8	4.2	
P8-LJ-30X-B	1.1	2.4	3.2	5.1	7.5	8.9	11.9	P8-LJ-30X-B	1.4	2.0	2.3	3.0	3.6	4.0	4.6
H8-LL-30X-B	1.2	2.7	3.6	5.7				H8-LL-30X-B	1.5	2.2	2.7	3.6			
H8-LL-40X-B	1.4	2.8	3.6	5.6	8.1	9.4		H8-LL-40X-B	1.7	2.4	2.8	3.7	4.7	5.3	
K9-LL-30X-B	1.2	2.7	3.6	5.7				K9-LL-30X-B	1.5	2.2	2.6	3.6			
P8-LL-40X-B	1.4	2.9	3.9	6.2	9.1	10.8		P8-LL-40X-B	1.7	2.4	2.8	3.6	4.5	5.0	
H8-LSG-40X-B	1.7	3.4	4.4	6.7				H8-LSG-40X-B	1.9	2.8	3.3	4.5			
K9-LSG-40X-B	1.7	3.4	4.4	6.7				K9-LSG-40X-B	1.9	2.8	3.3	4.5			

Conditions: EN13215: Suction Gas Return 20°C, Subcooling 0K

Condensing Units with Semi-Hermetic Discus™ Compressors

Copeland™ air-cooled indoor condensing units for medium temperature and low temperature applications.

In a further approach to improve compressor performance and reduce compression losses, Emerson Climate Technologies engineers developed the Discus valve technology.

This series of condensing units is equipped with 2 or 3 cylinder semi-hermetic compressors with Discus valve technology. The models are specifically suitable for those applications where high efficiency and low energy consumption is required.

The wide range of compressor models combined with 2 or 4 fan high capacity condensers covers most application needs of low temperature and medium temperature applications.



Condensing Units with Semi-Hermetic Discus Compressors

Discus Condensing Units Line-up

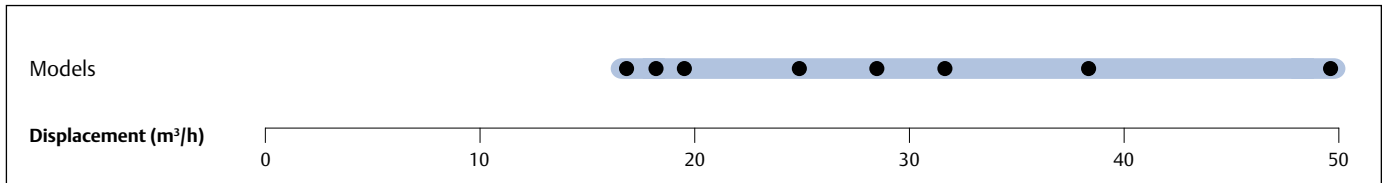

Features and Benefits

- Standard equipment: Discus compressor, condenser with thermally protected fan(s), discharge line with flexible pipe loop or vibration absorber, liquid receiver with shut-off valve, HP/LP switch with automatic reset, oil pressure safety control OPS2
- Suitable for multiple refrigerants: R404A, R407A, R407F, R507, R134a and R22
- Wide range of quality accessories
- Excellent efficiency
- Proven reliability

Maximum Allowable Pressures (PS)

- Low Side PS 22.5 bar (g)
- High Side PS = 28 bar (g)

Technical Overview

Models	Displacement (m ³ /h)	Number of fans	Total Fan Motor Power (W)	Suction Line Diameter (inch)	Liquid Line Diameter (inch)	Length/Width/Height (mm)	Net Weight (kg)	Motor Version/Code	Maximum Operating Current, A	Locked Rotor Current, A	Sound Pressure @10 m - d(BA)***
								3 Ph**	3 Ph**	3 Ph**	
P8-2DC-50X-B	17	2	220	1 3/8	5/8	740/950/633	186	AWM	9	55	
P8-2DB-50X-B	28	2	220	1 3/8	5/8	740/950/633	186	AWM	13.4	55	49.6
P8-3DA-50X-B	32	2	220	1 3/8	5/8	740/950/633	205	AWM	15.9	55	51.6
P8-2DB-75X-B	28	2	220	1 3/8	5/8	740/950/633	191	AWM	16.1	70	52
P8-2DL-75X-B	24	2	220	1 3/8	5/8	740/950/633		AWM	13.8	70	50
P8-3DA-75X-B	32	2	220	1 3/8	5/8	740/950/633	211	AWM	17.5	106	52
R7-2DD-50X-B	19	2	470	1 3/8	3/4	820/1130/633	196	AWM	10.3	55	
S9-2DB-75X-B	28	2	470	1 3/8	3/4	820/1130/708	212	AWM	16.1	70	
R7-2DL-75X-B	24	2	470	1 3/8	3/4	820/1130/708	205	AWM	13.8	70	
R7-3DC-75X-B	38	2	470	1 3/8	3/4	820/1130/633	278	AWM	18.3	70	54.6
R7-3DC-100X-B	38	2	470	1 3/8	3/4	820/1129/633	234	AWM	20.5	121	56
S9-3DS-100X-B	50	2	470	1 3/8	3/4	820/1130/708	239	AWM	24.4	121	54
S9-3DS-150X-B	50	2	470	1 3/8	3/4	820/1129/708	243	AWM	29	125.7	57
S9-3DA-75X-B	32	2	470	1 3/8	7/8	820/1330/835	259	AWM	17.5	106	
V6-3DC-100X-B	38	2	800	1 3/8	7/8	820/1330/835	278	AWM	20.5	121	
V6-3DS-150X-B	50	2	800	1 3/8	7/8	820/1330/835	280	AWM	29	125.7	
W9-3DS-150X-B	50	2	800	1 3/8	7/8	820/1640/869	303	AWM	29	125.7	

** 3 Ph: 380-420V/ 50Hz

*** @ 10m: sound pressure level at 10m distance from the compressor, free field condition

Capacity Data

Ambient Temperature: 32°C															
R134a		Cooling Capacity (kW)						R134a		Power Input (kW)					
		Evaporating Temperature (°C)								Evaporating Temperature (°C)					
Model	-45	-35	-30	-20	-10	-5	+5	Model	-45	-35	-30	-20	-10	-5	+5
P8-2DB-50X-B				5.1	8.4	10.3	14.5	P8-2DB-50X				2.8	3.7	4.1	5.1
P8-2DB-75X-B				4.5*	7.6*	9.5*	14.1*	P8-2DB-75X				2.8*	3.6*	4.0*	4.9*
P8-2DL-75X-B				3.7*	6.5*	8.2*	12.4*	P8-2DL-75X							4.0*
P8-3DA-50X-B				5.8	9.2	11.2	15.7	P8-3DA-50X				3.2	4.2	4.7	5.8
P8-3DA-75X-B				5.0*	8.6*	10.7*	15.8*	P8-3DA-75X				3.3*	4.1*	4.6*	5.7*
R7-3DC-75X-B				7.3	11.5	14.0	19.6	R7-3DC-75X				4.1	5.2	5.8	7.0
R7-3DC-100X-B				6.7*	11.0*	13.7*	20.0*	R7-3DC-100X				4.1*	5.2*	5.7*	6.9*
S7-2DL-75X-B				3.9*	6.8*	8.6*	13.2*	S7-2DL-75X				2.6*	3.2*	3.5*	4.1*
S9-2DB-75X-B				4.8*	8.3*	10.4*	15.7*	S9-2DB-75X				3.1*	3.7*	4.1*	4.7*
S9-3DS-100X-B				9.5	14.9	18.1	25.3	S9-3DS-100X				5.2	6.7	7.6	9.4
S9-3DS-150X-B				9.4*	14.8*	18.1*	25.8*	S9-3DS-150X				5.5*	6.9*	7.7*	9.4*
V6-3DC-100X-B				7.3*	12.2*	15.3*	23.1*	V6-3DC-100X				4.4*	5.2*	5.6*	6.3*
V6-3DS-100X-B				10.0	16.1	19.7	28.4	V6-3DS-100X				5.4	6.8	7.4	8.8
V6-3DS-150X-B				10.1*	16.1*	19.8*	29.1*	V6-3DS-150X				5.8*	7.0*	7.6*	8.9*

Conditions: EN13215: Suction Gas Return 20°C, Subcooling 0K

* Conditions: EN13215: Suction Superheat 10K

Ambient Temperature: 32°C															
R407A		Cooling Capacity (kW)						R407A		Power Input (kW)					
		Evaporating Temperature (°C)								Evaporating Temperature (°C)					
Model	-45	-35	-30	-20	-10	-5	+5	Model	-45	-35	-30	-20	-10	-5	+5
P8-3DA-50X-B		3.7*	5.0*	8,7	12,1			P8-3DA-50X-B		3.7*	5.0*	8,7	12,1		
P8-2DB-50X-B		3.3*	4.5*	7,9	11,3	13,2		P8-2DB-50X-B		3.3*	4.5*	7,9	11,3	13,2	
P8-2DC-50X-B		1,8	2,6	4,5	7,1	8,7	12,3	P8-2DC-50X-B		1,8	2,6	4,5	7,1	8,7	12,3
R7-2DD-50X-B		2,4	3,4	5,8	9,1	11,0	15,5	R7-2DD-50X-B		2,4	3,4	5,8	9,1	11,0	15,5
P8-3DA-75X-B				8,5	12,2			P8-3DA-75X-B				8,5	12,2		
P8-2DB-75X-B				7,9	11,4	13,2		P8-2DB-75X-B				7,9	11,4	13,2	
S9-2DB-75X-B				8,7	13,2	15,7	21,4	S9-2DB-75X-B				8,7	13,2	15,7	21,4
R7-3DC-75X-B		4.7*	6.3*	11,1	15,8	18,3		R7-3DC-75X-B		4.7*	6.3*	11,1	15,8	18,3	
P8-2DL-75X-B				6,6	10,0	11,9		P8-2DL-75X-B				6,6	10,0	11,9	
R7-3DC-100X-B				11,1	16,2	18,9		R7-3DC-100X-B				11,1	16,2	18,9	
V6-3DC-100X-B				12,6	19,1	22,9	31,5	V6-3DC-100X-B				12,6	19,1	22,9	31,5
S9-3DS-100X-B		6.3*	8.5*	14,7	20,5	23,6		S9-3DS-100X-B		6.3*	8.5*	14,7	20,5	23,6	
V6-3DS-150X-B				16,1	23,8	28,2	37,8	V6-3DS-150X-B				16,1	23,8	28,2	37,8
S9-3DS-150X		7.2	9.1	14.2	19.8			S9-3DS-150X		6.1	7.0	9.4	12.1		
V6-3DS-150X		7.7	10.0	16.1	23.5	27.3	35.0	V6-3DS-150X		6.2	7.1	9.3	11.8	13.0	15.2

Conditions: EN13215: Suction Gas Return 20°C, Subcooling 0K

* Conditions: EN13215: Suction Superheat 10K

Capacity Data

Ambient Temperature: 32°C															
R404A		Cooling Capacity (kW)						R404A		Power Input (kW)					
		Evaporating Temperature (°C)								Evaporating Temperature (°C)					
Model	-45	-35	-30	-20	-10	-5	+5	Model	-45	-35	-30	-20	-10	-5	+5
P8-2DC-50X-B		2.4	3.2	5.2	7.9	9.5	13	P8-2DC-50X		2.0	2.3	3.0	3.7	4.0	4.7
R7-2DD-50X-B		2.5	3.6	6.1	9.3	11.2	15.6	R7-2DD-50X		2.6	3.0	3.7	4.5	4.9	5.6
P8-3DA-75X-B			5.0	6.5	9.8			P8-3DA-75X			4.1	4.8	6.4		
R7-2DL-75X-B		3.8	5.0	8.0	11.8	13.9	18.6	R7-2DL-75X		3.2	3.6	4.5	5.6	6.1	7.3
P8-3DA-50X-B	2.3	5.4	6.7	9.6	11.9			P8-3DA-50X	2.9	4.2	5.0	6.5	8.2		
P8-2DB-50X-B	2.0	4.6	5.9	8.9	12.3			P8-2DB-50X	2.5	3.4	4.0	5.4	7.0		
P8-2DB-75X-B		4.9	6.14	9.2	12.3			P8-2DB-75X				4.4	5.6	6.4	
S9-2DB-75X-B		5.0	6.6	10.3	14.9	17.6	23.7	S9-2DB-75X		3.8	4.3	5.5	6.7	7.4	8.8
S9-3DA-75X-B		5.4	7.1	11.2	16.0	18.7		S9-3DA-75X		4.4	5.1	6.5	8.0	8.7	
R7-3DC-100X-B	3.1	6.7	8.4	12.1	16.2			R7-3DC-100X	3.9	5.4	6.2	7.9	9.9		
R7-3DC-75X-B	3.1	6.7	8.4	12.1	16.2			R7-3DC-75X	3.9	5.4	6.2	7.9	9.8		
V6-3DC-100X-B		6.1	8.2	13.3	19.7	23.5	32.5	V6-3DC-100X		5.3	6.1	7.6	9.1	9.8	11.2
S9-3DS-100X-B	4.2	9.0	11.3	16.2	19.9			S9-3DS-100X	5.1	7.1	8.2	10.7	13.4		
V6-3DS-150X-B		9.4	12.2	18.5	25.9	30.1	39.1	V6-3DS-150X		7.1	8.2	10.6	12.9	14.1	16.3
W9-3DS-150X-B		9.4	12.2	18.7	26.2	30.5	39.7	W9-3DS-150X		7.1	8.2	10.5	12.9	14.0	16.2

Conditions: EN13215: Suction Gas Return 20°C, Subcooling 0K

Ambient Temperature +32°C															
R407C		Cooling Capacity (kW)						R407C		Power Input (kW)					
		Evaporating Temperature (°C)								Evaporating Temperature (°C)					
Model	-20	-15	-10	-5	0	+5	+10	Model	-20	-15	-10	-5	0	+5	+10
P8-2DC-50X-B	4.1	5.3	6.8	8.4	10.2	12.1	14.2	P8-2DC-50X	2.3	2.6	3.0	3.3	3.7	4.2	4.6
R7-2DD-50X-B	5.1	6.6	8.4	10.4	12.6	15.0	17.6	R7-2DD-50X	2.9	3.3	3.6	4.0	4.4	4.9	5.3
R7-2DL-75X-B	6.3	8.0	10.1	12.4	14.9	17.7	20.6	R7-2DL-75X	3.5	4.0	4.5	5.1	5.6	6.2	6.9
S9-2DB-75X-B	8.2	20.2	12.5	15.1	18.0	21.0	24.3	S9-2DB-75X	4.4	4.9	5.5	6.1	6.7	7.4	8.1
S9-3DA-75X-B	9.0	11.2	13.9	16.8	20.0	23.3	26.9	S9-3DA-75X	5.1	5.6	6.3	7.0	7.8	8.6	9.5
V6-3DC-100X-B	11.4	14.3	17.6	21.4	25.6	30.2	35.1	V6-3DC-100X	6.1	6.7	7.4	8.2	8.9	9.7	10.6
V6-3DS-150X-B	15.3	18.7	22.6	26.9	31.7	36.8	42.2	V6-3DS-150X	8.4	9.3	10.3	11.3	12.5	13.8	15.2
W9-3DS-150X-B	15.4	18.9	22.9	27.4	32.3	37.7	43.3	W9-3DS-150X	8.3	9.2	10.2	11.2	12.3	13.6	14.9

Conditions: EN13215: Suction Gas Return 20°C, Subcooling 0K

Ambient Temperature +32°C															
R22		Cooling Capacity (kW)						R22		Power Input (kW)					
		Evaporating Temperature (°C)								Evaporating Temperature (°C)					
Model	-45	-35	-30	-20	-10	-5	+5	Model	-45	-35	-30	-20	-10	-5	+5
P8-2DC-50X-B				4.9	7.9	9.6	13.7	P8-2DC-50X-B				2.6	3.2	3.6	4.3
R7-2DD-50X-B				5.9	9.4	11.5	16.4	R7-2DD-50X-B				3.3	3.9	4.3	5.0
R7-2DL-75X-B				7.3	11.4	13.9	19.5	R7-2DL-75X-B				3.9	4.9	5.4	6.5
S9-2DB-75X-B				9.3	14.1	16.8	23.1	S9-2DB-75X-B				4.8	5.9	6.4	7.6
S9-3DA-750-B				10.3	15.8	18.9	26.0	S9-3DA-750-B				5.5	6.8	7.5	8.9
S9-3DA-75X-B				10.3	15.8	18.9	26.0	S9-3DA-75X-B				5.5	6.8	7.5	8.9
V6-3DC-100X-B				13.0	19.9	23.9	33.2	V6-3DC-100X-B				6.7	8.0	8.7	10.0
V6-3DS-150X-B				17.3	25.4	30.1	40.9	V6-3DS-150X-B				9.1	11.0	12.0	14.1
W9-3DS-150X-B				17.4	25.6	30.4	41.4	W9-3DS-150X-B				9.0	10.9	11.9	13.9

Conditions: EN13215: Suction Gas Return 20°C, Subcooling 0K

Condensing Units with Semi-Hermetic Stream Compressors and CoreSense™ Diagnostics

Copeland air-cooled indoor condensing units for low, medium and high temperature applications.

This series of condensing units is equipped with 4 or 6 cylinder high performance semi-hermetic Stream compressors. The advanced protection and diagnostic features reduce service costs and system downtime. These models are specifically suitable for those applications where high efficiency and reliability is required to achieve low lifecycle costs.

Multiple refrigerant approvals and wide range of accessories improve flexibility in system design.



Condensing Units with Semi-Hermetic Stream Compressors and CoreSense™ Diagnostics

Condensing Units with Stream Compressor Line-up

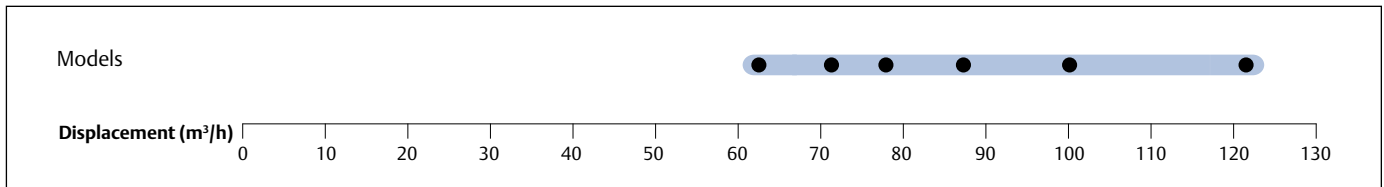

Features and Benefits

- Standard equipment: Stream compressor with CoreSense Diagnostics, condenser with thermally protected fan(s), discharge line with flexible pipe loop or vibration absorber, liquid receiver with shut-off-valve, HP/LP switch with automatic reset.
- Suitable for multiple refrigerants: R404A, R507, R134a, R407F, R407A, R407C, R22
- Wide range of quality accessories
- Excellent efficiency
- Proven reliability

Maximum Allowable Pressures (PS)

- Low pressure side = 22,5 bar
- High pressure side = 28 bar

CoreSense Diagnostics Features

- Motor and oil protection
- Storage of compressor asset and advanced runtime information
- Runtime and alarm signalling using multicoloured LED flash-codes
- System communication via Modbus
- Compressor power sensing

Technical Overview

Models	Displacement (m ³ /h)	Number of Fans	Total Fan Motor Power (kW)	Suction Line Diameter (inch)	Liquid Line Diameter (inch)	Length/Width Height (mm)	Net Weight (kg)	Motor Version/ Code	Maximum Operating Current (A)	Locked Rotor Current (A)	Sound Pressure @ 10m (dBA)**
								3 Ph*	3 Ph*	3 Ph*	
V6-4MF-13X	62	2	800	1 ½	¾	955/1289/835	295	AWM	30.8	105	57
V6-4ML-15X	71	2	800	1 ½	¾	955/1289/835	303	AWM	35.4	156	57
W9-4MM-20X	78	2	800	2 ½	¾	1107/1600/875	358	AWM	39	175	57
Z9-4MA-22X	62	4	1600	1 ½	¾	1107/1600/1263	383	AWM	36.3	175	59
W9-4MT-22X	88	2	800	2 ½	¾	1107/1600/875	358	AWM	44.5	175	59
Z9-4MT-22X	88	4	1600	2 ½	¾	1107/1600/1263	389	AWM	44.5	175	
Z9-4MH-25X	71	4	1600	2 ½	¾	1107/1600/1263	389	AWM	41.6	199	59
Z9-4MU-25X	100	4	1600	2 ½	¾	1107/1600/1263	392	AWM	51.9	199	59
Z9-4MI-30X	78	4	1600	2 ½	¾	1107/1600/1263	416	AWM	46.6	221	59
Z9-6MM-30X	121	4	1600	2 ½	¾	1130/1600/1263	410	AWM	59.7	255	59
Z9-4MJ-33X	88	4	1600	2 ½	¾	1107/1600/1263	416	AWM	52.9	221	59
W99-4MK-35X	100	4	1600	2 ½	¾	1189/1600/1803	504	AWM	61.1	255	59
W99-6MI-40X	121	4	1600	2 ½	¾	1213/1600/1803	521	AWM	71.4	304	59

* 3 PH: 380-420V/ 50Hz

** @ 10m: sound pressure level at 10m distance from the compressor, free field condition

Capacity Data

R134a	Cooling Capacity (kW)							R134a	Power Input (kW)						
	Evaporating Temperature (°C)								Evaporating Temperature (°C)						
Model	-45	-35	-30	-20	-10	-5	+5	Model	-45	-35	-30	-20	-10	-5	+5
V6-4MF-13X				12.4	19.6	23.8	33.8	V6-4MF-13X				6.6	8.2	9.1	10.9
V6-4ML-15X				14.8	22.9	27.7	38.6	V6-4ML-15X				7.7	9.8	10.9	13.2
W9-4MM-20X				16.4	25.2	30.3	42.1	W9-4MM-20X				8.5	10.8	12.0	14.6
Z9-4MA-22X				14.0	21.9	26.9	39.1	Z9-4MA-22X				7.4	8.8	9.4	10.6
W9-4MT-22X				18.5	28.0	33.6	45.9	W9-4MT-22X				9.7	12.3	13.7	16.9
Z9-4MT-22X				19.6	30.4	37.1	52.9	Z9-4MT-22X				10.2	12.4	13.6	15.9
Z9-4MH-25X				15.8	24.9	30.6	44.4	Z9-4MH-25X				8.5	10.2	11.1	12.6
Z9-4MU-25X				21.2	33.3	40.6	57.9	Z9-4MU-25X				11.3	14.0	15.4	18.3
Z9-4MI-30X				17.5	27.2	33.3	47.9	Z9-4MI-30X				9.1	11.0	12.0	13.8
Z9-6MM-30X				25.3	39.1	47.4	66.7	Z9-6MM-30X				13.3	16.7	18.4	22.1
Z9-4MJ-33X				19.5	30.1	36.7	52.4	Z9-4MJ-33X				10.2	12.3	13.4	15.5
W99-4MK-35X				21.8	33.7	41.0	58.5	W99-4MK-35X				11.2	13.8	15.2	18.0
W99-6MI-40X				25.2	39.0	47.4	67.3	W99-6MI-40X				13.5	16.5	18.2	21.7

Conditions: EN13215: Suction Gas Return 20°C, Subcooling 0K

*Suction Superheat 10K

Capacity Data

R407A	Cooling Capacity (kW)							R407A	Power Input (kW)						
	Evaporating Temperature (°C)								Evaporating Temperature (°C)						
	-45	-35	-30	-20	-10	-5	+5		-45	-35	-30	-20	-10	-5	+5
Model								Model							
V6-4MF-13X		7.5*	10.3*	18.4	26.5	31.0		V6-4MF-13X		6.9*	8.1*	10.9	14.0	15.8	
V6-4ML-15X		9.3*	12.6*	21.7	30.9	35.9		V6-4ML-15X		8.2*	9.6*	12.9	16.7	18.9	
W9-4MM-20X		10.5*	14.0*	23.8	33.8	39.2		W9-4MM-20X		9.0*	10.6*	14.3	18.5	20.9	
Z9-4MA-22X				20.9	32.1	38.8	54.6	Z9-4MA-22X				11.0	13.4	14.7	17.2
W9-4MT-22X		11.1*	14.7*	25.1	35.2	40.6		W9-4MT-22X		10.3*	12.1*	16.4	21.4	24.3	
Z9-4MT-22X		12.1*	17.9	28.4	41.9	49.8		Z9-4MT-22X		10.9*	12.6	16.2	20.1	22.2	
Z9-4MH-25X				24.0	36.5	43.9	61.4	Z9-4MH-25X				12.9	15.7	17.1	20.0
Z9-4MU-25X		13.2*	19.8	31.7	46.5	55.0		Z9-4MU-25X		12.1*	14.0	18.1	22.8	25.5	
Z9-4MI-30X				26.6	40.0	47.9	66.1	Z9-4MI-30X				14.2	17.4	19.0	22.5
Z9-6MM-30X		15.8*	21.4*	37.5	54.5	64.0		Z9-6MM-30X		14.2*	16.5*	21.7	27.6	30.9	
Z9-4MJ-33X				29.3	43.6	52.0	71.2	Z9-4MJ-33X				15.9	19.6	21.5	25.8
W99-4MK-35X				32.4	47.9	56.8	76.6	W99-4MK-35X				18.1	22.6	25.0	30.4
W99-6MI-40X				38.4	56.2	66.1	87.7	W99-6MI-40X				21.6	27.3	30.5	37.5

Conditions: EN13215: Suction Gas Return 20°C, Subcooling 0K
 * Suction Superheat 20K

R407F	Cooling Capacity (kW)							R407F	Power Input (kW)						
	Evaporating Temperature (°C)								Evaporating Temperature (°C)						
	-45	-35	-30	-20	-10	-5	+5		-45	-35	-30	-20	-10	-5	+5
Model								Model							
V6-4MF-13X		8.0*	11.0*	18.1*	27,5	32,1		V6-4MF-13X		7.2*	8.5*	11.4*	14,9	16,8	
V6-4ML-15X		9.9*	13.3*	21.4*	32,4			V6-4ML-15X		8.6*	10.1*	13.6*	17,9		
W9-4MM-20X		10.9*	14.6*	23.3*	35,1			W9-4MM-20X		9.6*	11.2*	15.0*	19,6		
Z9-4MA-22X				21.3*	34,0	41,1	57,5	Z9-4MA-22X				11.7*	14,2	15,5	18,0
W9-4MT-22X		12.4*	16.4*	25.5*				W9-4MT-22X		10.9*	12.7*	17.2*			
Z9-4MH-25X				24.4*	38,7	46,5	64,5	Z9-4MH-25X				13.5*	16,6	18,1	21,3
Z9-4MU-25X		14.8*	19.8*	32.2*	49,5	58,5		Z9-4MU-25X		12.7*	14.7*	19.1*	24,4	27,3	
Z9-4MI-30X				26.9*	42,0	50,2	68,8	Z9-4MI-30X				14.7*	18,2	20,0	23,9
Z9-6MM-30X		17.7*	23.7*	38.1*	58,0	68,1		Z9-6MM-30X		15.1*	17.4*	22.8*	29,3	32,8	
Z9-4MJ-33X				29.6*	45,9	54,6	74,1	Z9-4MJ-33X				16.5*	20,6	22,8	27,7
W99-4MK-35X				32.5*	50,1	59,3	79,8	W99-4MK-35X				18.8*	23,7	26,4	32,7
W99-6MI-40X				38.4*	59,0	69,3	91,6	W99-6MI-40X				22.6*	28,9	32,4	40,2

Conditions: EN13215: Suction Gas Return 20°C, Subcooling 0K
 * Suction Superheat 10K

Capacity Data

R404A	Cooling Capacity (kW)							R404A	Power Input (kW)						
	Evaporating Temperature (°C)								Evaporating Temperature (°C)						
Model	-45	-35	-30	-20	-10	-5	+5	Model	-45	-35	-30	-20	-10	-5	+5
V6-4MF-13X	4.3*	10.8	13.7	20.4	28.4	32.8		V6-4MF-13X	5.9*	8.2	9.5	12.3	15.3	16.9	
V6-4ML-15X	5.4*	13.0	16.4	23.9	32.6			V6-4ML-15X	7.1*	9.9	11.5	14.9	18.7		
W9-4MM-20X	6.3*	14.5	18.1	25.9	34.6			W9-4MM-20X	7.9*	11.0	12.7	16.5	20.7		
Z9-4MA-22X		11.7	15.3	24.0	34.8	41.0	55.0	Z9-4MA-22X		8.9	10.1	12.5	14.9	16.0	18.2
W9-4MT-22X	7.2*	15.9	19.7	28.1				W9-4MT-22X	8.8*	12.4	14.4	18.7			
Z9-4MT-22X	7.9*	17.7	22.2	33.3	46.9	54.6		Z9-4MT-22X	9.6*	13.0	14.7	18.5	22.4	24.4	
Z9-4MH-25X		13.4	17.5	27.3	39.6	46.7	62.8	Z9-4MH-25X		10.2	11.6	14.6	17.6	19.1	22.0
Z9-4MU-25X	8.4*	19.2	24.2	36.1	50.7			Z9-4MU-25X	10.5*	14.4	16.5	20.9	25.5		
Z9-4MI-30X		15.4	20.0	30.5	43.1	50.3	66.1	Z9-4MI-30X		11.4	13.0	16.3	19.6	21.2	24.6
Z9-6MM-30X	10.1*	22.8	28.5	42.0	58.2	67.2		Z9-6MM-30X	12.7*	17.3	19.8	25.3	31.2	34.3	
Z9-4MJ-33X		17.0	21.8	33.2	46.9	54.6	71.6	Z9-4MJ-33X		12.4	14.2	17.9	21.8	23.8	27.8
W99-4MK-35X		18.9	24.1	36.5	51.3	59.6	77.8	W99-4MK-35X		14.1	16.2	20.5	25.2	27.6	32.4
W99-6MI-40X		22.1	28.2	42.3	58.8	67.9		W99-6MI-40X		16.8	19.3	24.8	30.6	33.6	

Conditions: EN13215: Suction Gas Return 20°C, Subcooling 0K
*Suction Superheat 10K

R407C	Cooling Capacity (kW)							R407C	Power Input (kW)						
	Evaporating Temperature (°C)								Evaporating Temperature (°C)						
Model	-45	-35	-30	-20	-10	-5	+5	Model	-45	-35	-30	-20	-10	-5	+5
Z9-4MA-22X				20.0	30.4	36.7	51.5	Z9-4MA-22X				10.7	12.9	13.9	16.0
Z9-4MH-25X				22.7	34.8	42.0	58.8	Z9-4MH-25X				12.2	14.8	16.1	18.8
Z9-4MI-30X				25.3	38.3	46.0	64.0	Z9-4MI-30X				13.4	16.4	18.0	21.1
Z9-4MJ-33X				27.8	42.0	50.4	69.6	Z9-4MJ-33X				14.8	18.4	20.2	24.3
W99-4MK-35X				31.9	47.7	56.9	77.5	W99-4MK-35X				16.9	21.2	23.5	28.5
W99-6MI-40X				36.2	53.5	63.3	84.5	W99-6MI-40X				20.0	25.5	28.4	34.9

Conditions: EN13215: Suction Gas Return 20°C, Subcooling 0K
Suction Superheat 10K

Preliminary data

Compressors Motor Codes Table

Semi-Hermetic						
Motor Codes	Voltage	Connection		Motor Codes	Voltage	Connection
Standard Motor Version						
CAG	220-230/1/50	-				
EWL (DK, DL, D2S)	220-240/3/50	Δ		EWN (DK, DL, D2S)	250-280/3/60	Δ
EWL (DK, DL, D2S)	380-420/3/50	Y		EWN (DK, DL, D2S)	440-480/3/60	Y
AWM	380-420/3/50	YY/Y		AWD	440-480/3/60	YY/Y
Special Motor Version						
EWM	380-420/3/50	Δ/Y-Start		EWD	440-480/3/60	Δ/Y-Start
AWR	220-240/3/50	YY/Y		EWK (not D8)	220-240/3/60	Δ
AWY	500-550/3/50	YY/Y		EWK (not D8)	380-420/3/60	Y
				AWC	208-230/3/60	YY/Y
				AWX	380/3/60	YY/Y
Hermetic & Scroll						
Motor Codes	Voltage	Connection		Motor Codes	Voltage	Connection
Standard Motor Version						
PFJ	220-240/1/50	-		PFJ	265/1/60	-
PFT	220-240/1/50	-				
PFZ	220-240/1/50	-				
TFD	380-420/3/50	Y		TFD	460/3/60	Y
TFM	380-420/3/50	Y				
TWD	380-420/3/50	Y		TWD	460/3/60	Y
FWD	380-420/3/50	Δ/Δ				
FWM	380-420/3/50	Δ/Δ				
TWM	380-420/3/50	Y				
Special Motor Version						
TF5	200-220/3/50	Y		TF5	200-230/3/60	Y
TWR	220-240/3/50	Y		TW7	380/3/60	Y
TWC	200/3/50	Y		TWC	208-230/3/60	Y
TFE	500/3/50	Y		TFE	575/3/60	Y
TWE	500/3/50	Y		TWE	575/3/60	Y
				TF7	380/3/60	Y
TW5	200-220/3/50	Y		TW5	220-230/3/60	Y
Variable Speed Motor Version						
1E9	BPM Motor	-				

YY/Y = part-winding-start
 Δ/Δ = part-winding-start



Alco Controls

Alco Controls is the leading provider of precision electronic and electromechanical controls for the refrigeration and air conditioning markets. We continue to pioneer the control of refrigerant flow with innovative designs, keeping system performance optimization central to our product development.

The wide range of Emerson controllers covers all major applications in commercial air conditioning and refrigeration, as well as heat pump systems. There are stand-alone controllers and controllers with a communication interface.

The controllers with TCP/IP Ethernet communication feature a full web server function and provide full data exchange with any user in the World Wide Web. This allows quick and inexpensive monitoring from any PC with a standard web browser.

Emerson offers stepper motor drivers and superheat controllers for the electrically driven control valves, as well as capacity controllers for Copeland Digital Scroll compressors. See section “Electronic Controllers and Sensors” for more details.

Display case and cold room controllers provide all functions needed to run commercial refrigeration, like superheat control with electrical control valve, thermostat, fan and defrost control, integrated timer and alarm functions.

The compressor soft starter allows keeping the starting current below the limit imposed in residential heat pump applications.

Electronic fan speed controllers help to maintain a minimum condensing pressure by reducing fan speed at low ambient temperature.

Make use of Alco Controls pressure transmitters, temperature sensors and other assorted accessories compatible with all of the above-mentioned controllers.

Oil management components feature active oil level monitoring and balancing for optimal compressor protection. The patented TraxOil™ 3-zone level control technology is unique and offers comfortable monitoring and proactively protects the compressor against low oil levels.

Emerson’s controls portfolio is completed by offering a variety of mechanical controls such as:

- Pressostats & Thermostats
- System Protectors
- Valves
- Thermo™-Expansion Valves
- Oil Separators
- and Suction Accumulators

For the highest level of reliability and best performance, make sure your choice is Alco Controls.

Electrical Control Valves

Electrical Control Valve Technology

Thermostatic expansion valves and mechanical regulator valves have been used in the refrigeration and air conditioning industry to control superheat and refrigerant mass flow since its very beginning. As today's systems require improved energy efficiency, tighter temperature control, a wider range of operating conditions and incorporate new features like remote monitoring and diagnostics, the application of electronically operated valves becomes mandatory. Only these offer the controls performance necessary to meet these needs. Electrical control valves are actuators only. For operation in a system they need sensors, valve drivers and controllers, see next chapter.

The **EXM/EXL** biflow valves for OEM use are equipped with an unipolar stepper motor drive. They are mainly used for heat pumps, air conditioning and close control.

The **EX2** is designed for pulse width modulation. It is applicable to all common HCFC and HFC refrigerants and for subcritical CO₂ applications and is used mainly for refrigeration applications such as display cases. The EX2 valve is a slide type solenoid valve with an orifice for expansion. It is either completely open or completely closed. One common valve body can be combined with 6 interchangeable orifices to cover 7 capacity ranges.

The **EX4/EX5/EX6/EX7/EX8** consist of two main internal assemblies, the valve and the stepper motor. The stepper motor is located next to the electrical plug and connected directly to the slide and cage assembly of the valve. Similar to the technology used in compressors, the motor is exposed to refrigerant and lubricant and the materials used are identical to the ones in compressor

motors. The housing of the motor and valve assembly is made from stainless steel and fully hermetic, utilising exclusively brazing and welding technologies and eliminating all gaskets. This design offers several technical advantages such as proportional linear mass flow and a wide capacity range. A common feature of all EX2, EX4-8 electrical control valves is the positive shut-off function, which eliminates the need for additional solenoid valves.

The **CX4/CX5/CX6/CX7** High Pressure Expansion Valves are stepper motor driven valves for precise control of R744 (CO₂) refrigerant mass flow in air conditioning, refrigeration and heat pump applications. The Control Valves also can be used for liquid injection duty and hot gas bypass.

Valve Selection

For the **EX2**, the published table quotes capacities at 100% duty cycle, i.e. valve open continuously. However, it is recommended to operate the valve at partial load (50-80%) to allow for system load fluctuations. For **EX4/EX5/EX6/EX7/EX8** and **EXM/EXL** valves, all published capacities are maximum and there are no reserve capacities. Each valve should be selected for the highest possible capacity of the system. A wide range regulation (10 ... 100%) with one slide orifice for each valve is achievable. To facilitate valve dimensioning for other than the standard conditions, Emerson Climate offers the program "Copeland Select". This can be downloaded from www.emersonclimate.eu.

Selection Table for Electrical Control Valves and Applicable Controllers

Valve type	Function	Capacity kW R407C	Feature	Min. Evaporating Temp. °C	Main Application	Applicable Controller
EXM EXL	Expansion Valve	5 .. 20.7	Uni polar stepper motor driven	-30	Heat pumps, Air Conditioning, Close Control	EXD-HP1/2
EX2	Exp. Valve	1.0 .. 18.7	PWM	-40	Refrigeration	EC2
EX4 EX5 EX6 EX7 EX8	Expansion Valve	2 .. 17.4 5 .. 53 15 .. 126 35 .. 347 100 .. 925	Bi polar stepper motor driven	-50 -100	Heat pumps, Refrigeration, Air Conditioning, Water Chillers	EC3-X .. Superheat Contr. EC3-3 .. Coldroom Contr. EXD-U
EX4 EX5 EX6 EX7 EX8	Capacity Control	4.9 16 37 131 399	Bi polar stepper motor driven	-100	Hot gas bypass regulator	EXD-U .. Universal Driver Module
EX6 EX7 EX8	Liquid Mass Flow Control	3.9 14 42	Bi polar stepper motor driven	-50	Suction pressure / Crankcase pressure regulator	EXD-U .. Universal Driver Module
EX5 EX6 EX7 EX8	Heat Reclaim	18 43 153 463	Bi polar stepper motor driven	-	Condensing pressure and liquid regulator	EXD-U .. Universal Driver Module
EX6 EX7 EX8	Heat Reclaim	11 39 119	Bi polar stepper motor driven	-	Heat Reclaim applications	EXD-U .. Universal Driver Module
CX4 CX5 CX6 CX7	Expansion Valve		Bi polar stepper motor driven	-	Refrigeration CO ₂ transcritical	EXD-U .. Universal Driver Module

Electrical Control Valves Series EXM/EXL

for OEM use, stepper motor driven

Features

- Unipolar stepper motor
- Bi-flow (same performance in both flow directions in term of capacity)
- High MOPD: 40 bar in normal flow direction
- Removable coils in two versions: 12VDC/24VDC
- Continuous modulation of mass flow, no stress (liquid hammering) in the refrigeration circuit
- Linear flow
- Resolution: 500 pulses (half steps) or 250 full steps
- Hermetic design
- Only Bulk packing in boxes of 10 identical pieces
- Reliability: 225 millions pulses at continuous 40 bar differential pressure
- The valve is not released for refrigeration applications such as cold rooms and refrigeration display cabinets.



EXM/EXL with Coil

Selection Chart

Type	Part No.	Description	Nominal Capacity kW			Connection size/style
			R410A	R407C	R134a	
EXM-B0A	800 399M	Valve less coil	1.8	1.6	1.2	1/4" ODM
EXM-B0B	800 400M	Valve less coil	5.5	5.0	3.7	
EXM-B0D	800 401M	Valve less coil	11.6	10.5	7.7	
EXM-B0E	800 402M	Valve less coil	13.7	12.4	9.1	
EXM-125	800 403M	Coil 12VDC, 5 wires	-	-	-	
EXM-24U	800 415M	Coil 24VDC, 6 wires	-	-	-	
EXL-B1F	800 405M	Valve less coil	17.0	15.4	11.3	1/4" ODF
EXL-B1G	800 406M	Valve less coil	23.0	20.7	15.2	8 mm ODM
EXL-125	800 407M	Coil 12VDC, 5 wires	-	-	-	
EXL-24U	800 416M	Coil 24VDC, 6 wires	-	-	-	

The nominal capacity is based on the following conditions:

Refrigerant	Evaporating temperature	Condensing temperature	Subcooling
R407C	+4°C (dew point)	+38°C bubble point / +43°C dew point	1K
R134a, R410A	+4°C	+38°C	1K

Technical Data

Max. allowable pressure PS	45 bar
MOPD	40 bar in normal flow direction
Temperature range TS	-30 to +70°C (liquid refrigerant) -30 to +60°C (ambient)
CE marking	Not required
Weight	Valve EXM: 65 g, EXL: 76 g Coil EXM: 124 g, EXL: 156 g
Package and delivery	Bulk pack with 10 pieces

Stepper motor type	Uni-polar, constant voltage
Full travel time	16.6 seconds at 30 pulse/sec. 5.5 seconds at 90 pulse/sec
Reference position	Mechanical stop at fully close position
Total number of pulses	500 half step (250 full step)
Insulation class	EXM: A EXL: E
Cable length	1m

Electronic Expansion Valves Series EX2

Pulse width modulated with exchangeable orifices

Can be used with EC2 display case controllers

Features

- Pulse width modulated
- Shut-off function eliminates the necessity of a separate solenoid valve
- Dampened plunger reduces noise effects of water hammer
- One valve body can be combined with 6 orifices to make 7 capacity ranges
- Applicable to all common refrigerants (HCFC, HFC) and for subcritical CO₂ applications
- Long lifetime, high reliability
- PS: 40bar, TS: -40 to +65°C



Selection Chart

Type	Part No.	Function	Capacity Q _n at 100% open Valve (kW) *						
			R134a	R22	R404A	R507	R407C	R744	R407F
EX2-M00	801 091	10 mm inlet / 12 mm outlet ODF	13.3	17.2	12.1	12.1	18.7	35.0	19.2
EX2-I00	801 090	¾" inlet / ½" outlet ODF							
EXO-004	801 089	Orifice 4	8.5	10.9	7.7	7.7	11.8	22.2	12.2
EXO-003	801 088	Orifice 3	5.6	7.2	5.1	5.1	7.8	14.6	8.0
EXO-002	801 087	Orifice 2	3.3	4.3	3.0	3.0	4.7	8.7	4.8
EXO-001	801 086	Orifice 1	2.5	3.2	2.3	2.3	3.5	6.5	3.6
EXO-000	801 085	Orifice 0	1.2	1.6	1.1	1.1	1.7	3.3	1.8
EXO-00X	801 084	Orifice X	0.7	0.9	0.6	0.6	1.0	1.8	1.0
ASC3 24V	801 079	Coil 24 VAC 50 (60)Hz (8W)							

* Orifice should be selected at max. 80% of Q_n to allow covering the load fluctuation

Description	Type	PCN (single packing)	PCN (bulk packing)
Plug and cable assembly (1.5 m)	ASC-N15	804570	804570M
Plug and cable assembly (3.0 m)	ASC-N30	804571	804571M
Plug and cable assembly (6.0 m)	ASC-N60	804572	-
Plug PG9	Plug	801012	-
Plug PG11	Plug	801013	-

The nominal capacity (Q_n) is based on the following conditions:

Refrigerant	Evaporating temperature	Condensing temperature	Subcooling
R407C, R407F	+4°C (dew point)	+38°C bubble point / +43°C dew point	1K
R22, R134a, R404A, R507	+4°C	+38°C	1K
R744	-40°C	-10°C	1K

For other operating conditions the selection tool "Copeland Select" can be downloaded from www.emersonclimate.eu, or use correction factors with following formula:

$$Q_n = Q_o \times K_t \times K_{\Delta p}$$

- Q_n: Nominal valve capacity
 Q_o: Required cooling capacity
 K_t: Correction factor for evaporating and liquid temperature
 K_{Δp}: Correction factor for pressure drop at valve

Liquid Temperature entering Valve °C	Correction Factor Kt											
	Evaporating Temperature °C											
	+15	+10	+5	0	-5	-10	-15	-20	-25	-30	-40	
+55	1.21	1.23	1.26	1.29	1.33	1.33	1.39	1.43	1.47	1.52	1.62	
+50	1.13	1.15	1.17	1.20	1.23	1.26	1.28	1.32	1.36	1.39	1.48	
+45	1.06	1.08	1.10	1.12	1.15	1.17	1.19	1.22	1.26	1.29	1.37	
+40	0.99	1.01	1.03	1.05	1.08	1.10	1.12	1.14	1.17	1.20	1.27	
+35	0.94	0.96	0.97	0.99	1.01	1.03	1.05	1.07	1.10	1.12	1.18	
+30	0.89	0.91	0.92	0.94	0.96	0.98	0.99	1.01	1.03	1.06	1.11	
+25	0.85	0.86	0.87	0.89	0.91	0.92	0.94	0.95	0.97	1.00	1.04	
+20	0.81	0.82	0.83	0.85	0.89	0.88	0.89	0.91	0.92	0.94	0.98	
+15	0.77	0.78	0.79	0.81	0.82	0.84	0.84	0.86	0.88	0.89	0.93	
+10		0.75	0.76	0.77	0.78	0.80	0.81	0.82	0.84	0.85	0.89	
+5			0.73	0.74	0.75	0.76	0.77	0.78	0.80	0.81	0.84	
0				0.71	0.72	0.73	0.74	0.75	0.76	0.78	0.81	
-5					0.69	0.70	0.71	0.72	0.73	0.74	0.77	
-10						0.68	0.68	0.69	0.70	0.71	0.74	

Correction Factor KΔp																								
Δp	3.5	4.0	4.5	5.0	5.5	6.0	6.5	7.0	7.5	8.0	8.5	9.0	10.0	11.0	12.0	13.0	14.0	15.0	16.0	17.0	18.0	19.0	20.0	21.0
KΔp	1.34	1.25	1.18	1.12	1.07	1.02	0.98	0.95	0.91	0.88	0.86	0.83	0.79	0.75	0.72	0.69	0.67	0.65	0.63	0.61	0.59	0.57	0.56	0.55

Liquid Temperature entering Valve °C	Correction Factor Kt												
	Evaporating Temperature °C												
	+15	+10	+5	0	-5	-10	-15	-20	-25	-30	-35	-40	
+55	1.42	1.46	1.50	1.55	1.61	1.68	1.75	1.83	1.92	2.01	2.13	2.25	
+50	1.23	1.26	1.30	1.34	1.38	1.43	1.48	1.54	1.61	1.68	1.75	1.84	
+45	1.10	1.12	1.15	1.18	1.22	1.26	1.30	1.34	1.39	1.45	1.51	1.57	
+40	0.99	1.02	1.04	1.07	1.09	1.13	1.16	1.20	1.24	1.28	1.33	1.38	
+35	0.91	0.93	0.95	0.97	1.00	1.02	1.05	1.08	1.11	1.15	1.19	1.23	
+30	0.84	0.86	0.88	0.90	0.92	0.94	0.96	0.99	1.02	1.05	1.08	1.11	
+25	0.79	0.80	0.82	0.83	0.85	0.87	0.89	0.92	0.94	0.97	0.99	1.02	
+20	0.74	0.75	0.77	0.78	0.80	0.81	0.83	0.85	0.87	0.90	0.92	0.95	
+15	0.70	0.71	0.72	0.73	0.75	0.76	0.78	0.80	0.82	0.84	0.86	0.88	
+10		0.67	0.68	0.69	0.71	0.72	0.74	0.75	0.77	0.79	0.81	0.83	
+5			0.65	0.66	0.67	0.68	0.70	0.71	0.73	0.74	0.76	0.78	
0				0.63	0.64	0.65	0.66	0.68	0.69	0.71	0.72	0.74	
-5					0.61	0.62	0.63	0.65	0.66	0.67	0.69	0.70	
-10						0.60	0.61	0.62	0.63	0.64	0.65	0.67	

Correction Factor KΔp																								
Δp	3.5	4.0	4.5	5.0	5.5	6.0	6.5	7.0	7.5	8.0	8.5	9.0	10.0	11.0	12.0	13.0	14.0	15.0	16.0	17.0	18.0	19.0	20.0	21.0
KΔp	1.74	1.63	1.54	1.46	1.39	1.33	1.28	1.23	1.19	1.15	1.12	1.09	1.03	0.98	0.94	0.9	0.87	0.84	0.81	0.79	0.77	0.75	0.73	0.71

Liquid Temperature entering Valve °C	Correction Factor Kt											
	Evaporating Temperature °C											
	+5	0	-5	-10	-15	-20	-25	-30	-35	-40		
+5	1.12	1.10	1.09	1.08	1.08	1.08	1.07	1.07	1.08	1.08		
0		1.02	1.01	1.01	1.00	1.00	1.00	1.00	1.00	1.01		
-5			0.95	0.94	0.94	0.94	0.94	0.94	0.94	0.94		
-10				0.89	0.89	0.88	0.88	0.88	0.89	0.89		
-15					0.84	0.84	0.84	0.84	0.84	0.84		
-20						0.80	0.80	0.80	0.80	0.80		
-25							0.76	0.76	0.76	0.76		
-30								0.73	0.73	0.73		
-35									0.70	0.70		
-40										0.67		

Correction Factor KΔp																								
Δp	5.0	6.0	7.0	8.0	9.0	10.0	11.0	12.0	13.0	14.0	15.0	16.0	17.0	18.0	19.0	20.0	21.0	22.0	23.0	24.0	25.0	26.0	27.0	28.0
KΔp	1.81	1.65	1.53	1.43	1.35	1.28	1.22	1.17	1.12	1.08	1.05	1.01	0.98	0.95	0.93	0.91	0.88	0.86	0.84	0.83	0.81	0.79	0.78	0.77

Liquid Temperature entering Valve °C	R22	Correction Factor Kt																						
		Evaporating Temperature °C																						
		+15	+10	+5	0	-5	-10	-15	-20	-25	-30	-35	-40											
+55	1.17	1.19	1.20	1.22	1.24	1.25	1.27	1.29	1.32	1.34	1.37	1.39												
+50	1.11	1.11	1.13	1.15	1.16	1.18	1.20	1.22	1.24	1.26	1.28	1.30												
+45	1.05	1.05	1.07	1.08	1.10	1.12	1.13	1.15	1.17	1.18	1.20	1.23												
+40	1.00	1.01	1.02	1.03	1.04	1.06	1.07	1.09	1.10	1.12	1.14	1.16												
+35	0.95	0.96	0.97	0.98	0.99	1.01	1.02	1.03	1.05	1.06	1.08	1.10												
+30	0.91	0.92	0.93	0.94	0.95	0.96	0.97	0.98	1.00	1.01	1.03	1.04												
+25	0.87	0.88	0.89	0.89	0.91	0.92	0.93	0.94	0.95	0.96	0.98	0.99												
+20	0.83	0.84	0.85	0.86	0.87	0.88	0.89	0.90	0.91	0.92	0.93	0.95												
+15	0.80	0.81	0.81	0.82	0.83	0.84	0.85	0.86	0.87	0.88	0.89	0.91												
+10		0.78	0.78	0.79	0.80	0.81	0.82	0.83	0.84	0.85	0.86	0.87												
+5			0.75	0.76	0.77	0.78	0.79	0.79	0.80	0.81	0.82	0.83												
0				0.73	0.74	0.75	0.76	0.77	0.77	0.78	0.79	0.80												
-5					0.72	0.72	0.73	0.74	0.75	0.75	0.76	0.77												
-10						0.70	0.71	0.71	0.72	0.73	0.74	0.74												
Correction Factor KΔp																								
Δp	3.5	4.0	4.5	5.0	5.5	6.0	6.5	7.0	7.5	8.0	8.5	9.0	10.0	11.0	12.0	13.0	14.0	15.0	16.0	17.0	18.0	19.0	20.0	21.0
KΔp	1.59	1.49	1.40	1.33	1.27	1.22	1.17	1.13	1.09	1.05	1.02	0.99	0.94	0.90	0.86	0.83	0.80	0.77	0.75	0.72	0.70	0.68	0.67	0.65

Liquid Temperature entering Valve °C	R507	Correction Factor Kt																						
		Evaporating Temperature °C																						
		+15	+10	+5	0	-5	-10	-15	-20	-25	-30	-35	-40											
+55	1.39	1.43	1.47	1.52	1.57	1.62	1.69	1.76	1.83	1.92	2.02	2.12												
+50	1.22	1.24	1.28	1.31	1.35	1.40	1.44	1.49	1.55	1.61	1.68	1.76												
+45	1.09	1.11	1.14	1.17	1.20	1.23	1.27	1.31	1.36	1.40	1.46	1.52												
+40	0.99	1.01	1.03	1.06	1.08	1.11	1.14	1.17	1.21	1.25	1.29	1.34												
+35	0.91	0.93	0.95	0.97	0.99	1.01	1.04	1.07	1.10	1.13	1.16	1.20												
+30	0.85	0.86	0.88	0.89	0.91	0.93	0.96	0.98	1.01	1.03	1.06	1.09												
+25	0.79	0.80	0.82	0.83	0.85	0.87	0.89	0.91	0.93	0.95	0.98	1.01												
+20	0.74	0.75	0.77	0.78	0.79	0.81	0.83	0.85	0.87	0.89	0.91	0.93												
+15	0.71	0.71	0.72	0.73	0.75	0.76	0.78	0.79	0.81	0.83	0.85	0.87												
+10		0.67	0.68	0.69	0.70	0.72	0.73	0.74	0.76	0.78	0.79	0.81												
+5			0.64	0.65	0.67	0.68	0.69	0.70	0.72	0.73	0.75	0.76												
0				0.62	0.63	0.64	0.65	0.66	0.68	0.69	0.70	0.72												
-5					0.60	0.61	0.62	0.63	0.64	0.65	0.66	0.68												
-10						0.58	0.59	0.60	0.61	0.62	0.63	0.64												
Correction Factor KΔp																								
Δp	3.5	4.0	4.5	5.0	5.5	6.0	6.5	7.0	7.5	8.0	8.5	9.0	10.0	11.0	12.0	13.0	14.0	15.0	16.0	17.0	18.0	19.0	20.0	21.0
KΔp	1.75	1.64	1.54	1.46	1.4	1.34	1.28	1.24	1.19	1.16	1.12	1.09	1.03	0.99	0.94	0.91	0.87	0.84	0.82	0.79	0.77	0.75	0.73	0.71

Liquid Temperature entering Valve °C	R407C	Correction Factor Kt																						
		Evaporating Temperature °C																						
		+15	+10	+5	0	-5	-10	-15	-20	-25	-30	-35	-40											
+55	1.26	1.28	1.31	1.34	1.37	1.40	1.44	1.48	1.52															
+50	1.15	1.17	1.19	1.22	1.24	1.27	1.30	1.33	1.37															
+45	1.06	1.08	1.10	1.12	1.14	1.17	1.19	1.22	1.25															
+40	0.99	1.01	1.02	1.04	1.06	1.08	1.11	1.13	1.16															
+35	0.93	0.94	0.96	0.98	0.99	1.01	1.03	1.05	1.07															
+30	0.88	0.89	0.90	0.92	0.93	0.95	0.97	0.99	1.01															
+25	0.83	0.84	0.85	0.87	0.88	0.90	0.91	0.93	0.95															
+20	0.79	0.80	0.81	0.82	0.84	0.85	0.86	0.88	0.90															
+15	0.75	0.76	0.77	0.78	0.80	0.81	0.82	0.84	0.85															
+10		0.73	0.74	0.75	0.76	0.77	0.78	0.80	0.81															
+5			0.71	0.72	0.73	0.74	0.75	0.76	0.77															
0				0.69	0.70	0.71	0.72	0.73	0.74															
-5					0.67	0.68	0.69	0.70	0.71															
-10						0.65	0.66	0.67	0.68															
Correction Factor KΔp																								
Δp	3.5	4.0	4.5	5.0	5.5	6.0	6.5	7.0	7.5	8.0	8.5	9.0	10.0	11.0	12.0	13.0	14.0	15.0	16.0	17.0	18.0	19.0	20.0	21.0
KΔp	1.81	1.69	1.59	1.51	1.44	1.38	1.33	1.28	1.23	1.19	1.16	1.13	1.07	1.02	0.98	0.94	0.9	0.87	0.84	0.82	0.8	0.78	0.76	0.74

Electronic Expansion Valves Series CX2

Pulse width modulated with exchangeable orifices for high-pressure CO₂ applications

Can be used with EC2 display case controllers

Features

- Pulse width modulated
- Shut-off function eliminates the necessity of a separate solenoid valve
- Dampened plunger reduces noise effects of water hammer
- One valve body can be combined with 6 orifices to make 7 capacity ranges up to 28.2 kW (R744)
- Long lifetime, high reliability
- PS: 90bar
- MOPD: 65 bar



CX2 with Orifice

Selection Chart

Valve		Orifice		Nominal Capacity kW (R744)
Type	Part No.	Type	Part No.	
CX2-I00	801 095	EX0-00X	801 084	1.5
CX2-I00	801 095	EX0-000	801 085	2.6
CX2-I00	801 095	EX0-001	801 086	5.2
CX2-I00	801 095	EX0-002	801 087	7
CX2-I00	801 095	EX0-003	801 088	11.8
CX2-I00	801 095	EX0-004	801 089	17.9
CX2-I00	801 095			28.2
Coil				
Type	Part No.	Description		
ASC3 24V	801 079	Coil 24 VAC 50 (60)Hz (8W)		

* Orifice should be selected at max. 80% of Qn to allow covering the load fluctuation

Description	Type	PCN (single packing)	PCN (bulk packing)
Plug and cable assembly (1.5 m)	ASC-N15	804570	804570M
Plug and cable assembly (3.0 m)	ASC-N30	804571	804571M
Plug and cable assembly (6.0 m)	ASC-N60	804572	-
Plug PG9	Plug	801012	-
Plug PG11	Plug	801013	-

For other operating conditions the selection tool “Copeland Select” can be downloaded from www.emersonclimate.eu.

Electrical Control Valves Series EX4, EX5, EX6, EX7 & EX8

Features

- Multifunction as expansion valve, hot gas bypass, suction gas throttling, head pressure, liquid level actuator etc.
- Fully hermetic design (no thread joints between valve body and motor compartment)
- Applicable to all common refrigerants (HCFC, HFC) and for subcritical CO₂ applications
- Stepper motor driven
- Short opening and closing time
- Very fast full-stroke time
- High resolution and excellent repeatability
- Positive shut-off function to eliminate the need for additional solenoid valve
- Bi-flow versions for heat pump applications
- High linear flow capacity
- Extremely wide capacity range (10 ... 100%)
- Continuous modulation of mass flow, no stress (liquid hammering) in the refrigeration circuit
- Direct coupling of motor and valve for high reliability (no gear mechanism)
- Ceramic slide and port for highly accurate flow and minimal wear
- Europe patent No. 0743476, USA patent No. 5735501, Japan patent No. 28225789
- Balanced force design
- Corrosion resistant stainless steel body and stainless steel connections
- PS: EX4-EX7 60 bar, EX8 45 bar
- Liquid Inlet Temperature TS:
- Uniflow: -50 to +100°C, Biflow: -40 to +80°C



Selection Chart (Capacities see following pages)

Type	Part No.	Flow Pattern	Capacity Range	Inlet Connection	Outlet Connection	Electrical Connection
EX4-I21	800 615	Uni-flow	10 ... 100%	3/8" ODF	5/8" ODF	M12 Plug
EX4-M21	800 616			10mm ODF	16mm ODF	
EX5-U21	800 618			5/8" (16mm) ODF	7/8" (22mm) ODF	
EX6-I21	800 620			7/8" ODF	1-1/8" ODF	
EX6-M21	800 621			22mm ODF	28 mm ODF	
EX7-I21	800 624			1-1/8" ODF	1-3/8" ODF	
EX7-M21	800 625			28mm ODF	35mm ODF	
EX8-M21	800 629			42mm ODF	42mm ODF	
EX8-U21	800 630			1-3/8" (35mm) ODF	1-3/8" (35mm) ODF	
EX8-I21	800 631			1-5/8" ODF	1-5/8" ODF	
EX4-U31	800 617	Bi-flow (Heat Pump)		5/8" (16mm) ODF	5/8" (16mm) ODF	
EX5-U31	800 619			7/8" (16mm) ODF	7/8" (22mm) ODF	
EX6-I31	800 622			1-1/8" ODF	1-1/8" ODF	
EX6-M31	800 623			28mm ODF	28mm ODF	
EX7-U31	800 626			1-3/8" (35mm) ODF	1-3/8" (35mm) ODF	

Cable Connector Assemblies

Type	Part No.	Temperature Range	Length	Connector type to valve	Connector type to driver or controller	Illustration
EXV-M15	804 663	-50 ... +80°C	1.5 m	M12, 4 pins	Loose wires	
EXV-M30	804 664		3.0 m			
EXV-M60	804 665		6.0 m			

Capacity Data

Application Expansion Valve and Liquid Injection Valve Nominal Capacity kW

Valve Type	R407C	R22	R134a	R404A	R410A	R23 *	R124 *	R744	R407F
EX4	2 .. 17.4	2 .. 16.5	1 .. 12.8	1 .. 11.5	2 .. 19.3	2 .. 17.8	1 .. 9.2	3 .. 33.5	18
EX5	5 .. 53	5 .. 50	4 .. 39	4 .. 35	6 .. 58	5 .. 54	3 .. 28	10 .. 102	56
EX6	15 .. 126	15 .. 120	10 .. 93	10 .. 84	15 .. 140	13 .. 130	7 .. 67	24 .. 244	134
EX7	35 .. 347	35 .. 330	25 .. 255	25 .. 230	40 .. 385	-	-	70 .. 670	369
EX8	100 .. 925	90 .. 880	70 .. 680	60 .. 613	100 .. 1027	-	-	180 .. 1789	984

* Biflow versions are not released for R124 and R23
Capacity for biflow versions identical in both flow directions.

The nominal capacity (Q_n) is based on the following conditions:

Refrigerant	Evaporating temperature	Condensing temperature	Subcooling
R407C, R407F	+4°C (dew point)	+38°C bubble point / +43°C dew point	1K
R22, R134a, R404A, R410A	+4°C	+38°C	1K
R124	+20°C	+80°C	1K
R23	-60°C	-25°C	1K
R744	-40°C	-10°C	1K

Guideline for Selection of Electrical Control Valves as Expansion Valves

Alco Selection Tool

For easy and quick selection of Electrical Control Valves as Expansion Valves, Copeland Select can be downloaded from the Internet at www.emersonclimate.eu, or use the quick selection tables on the following pages.

The following guideline should be taken into consideration in order to obtain full advantages of the control valves:

- **Published capacities are maximum and there are no reserve capacities**
- Larger size of valve leads to shorter pull-down period and shorter travel time i.e., faster response. For example, the EX7 has a maximum travel time of 3.2 seconds. The valve has approximately 1.6 seconds travel time at 50% capacity operation.

For controllers, see chapter "Electronic Controllers and Sensors".

Example:

System with R407C having two different operating conditions:

A) 110 kW capacity at +4°C/+50°C with two stages

compressor at 50% / 100% capacity

B) 137 kW capacity at +4°C/+30°C with two stages

compressor at 50% / 100% capacity

The EX6 with 126 kW covers condition A, however is not sufficient to cover condition B. It is recommended to select larger valve i. e. the EX7 with 337 kW at condition A and 293 kW at condition B.

Condition A:

Full load ratio = $110 / 337 = 33\%$

Partial load ratio = $(110/2) / 337 = 16\%$

Condition B:

Full load ratio = $137 / 293 = 47\%$

Partial load ratio = $(137/2) / 293 = 23\%$

The capacity ratios of system to valve are in all conditions higher than 10%. It is recommended to use the EX7 rather than the EX6.

Application Expansion Valve and Liquid Injection Valve

Condensing Temperature °C	R134a		Extended capacity (kW) Evaporating Temperature (°C)											Valve Type
	+15	+10	+5	0	-5	-10	-15	-20	-25	-30	-35	-40	-45	
+60	13	13	13	13	13	13	12	12	12	12	11	11	11	EX4
	39	39	39	39	39	39	38	37	36	35	34	33	32	EX5
	93	94	94	94	93	92	90	89	87	84	82	79	77	EX6
	255	257	258	257	255	252	248	243	237	231	224	217	210	EX7
	679	686	688	686	680	672	661	648	633	616	598	580	560	EX8
+55	12	13	13	13	13	13	13	12	12	12	12	11	11	EX4
	38	39	39	39	39	39	38	38	37	36	35	34	33	EX5
	91	92	93	94	93	93	92	90	88	86	84	82	80	EX6
	249	253	256	257	256	254	251	247	242	237	231	225	218	EX7
	663	676	683	685	683	678	670	659	647	632	616	599	582	EX8
+50	12	12	13	13	13	13	13	12	12	12	12	12	11	EX4
	36	38	38	39	39	39	38	38	37	37	36	35	34	EX5
	87	90	91	92	93	92	92	91	89	88	86	84	81	EX6
	238	246	250	253	254	253	251	249	245	240	235	229	223	EX7
	636	655	668	675	677	676	671	663	653	640	627	611	595	EX8
+45	11	12	12	12	12	13	12	12	12	12	12	12	11	EX4
	34	36	37	38	38	38	38	38	37	37	36	35	35	EX5
	81	85	88	90	91	91	91	90	89	88	86	84	82	EX6
	223	234	241	246	248	249	249	247	244	240	236	231	226	EX7
	595	623	642	655	662	664	663	658	651	641	629	616	602	EX8
+40	10	11	11	12	12	12	12	12	12	12	12	12	11	EX4
	31	33	35	36	37	37	37	37	37	36	36	35	34	EX5
	74	79	83	85	87	88	89	88	88	87	85	84	82	EX6
	202	217	227	234	239	242	243	242	240	238	234	230	225	EX7
	539	578	606	625	638	645	647	646	641	634	625	614	601	EX8
+35	9	10	10	11	11	12	12	12	12	12	12	11	11	EX4
	27	30	32	34	35	35	36	36	36	36	35	35	34	EX5
	63	71	76	80	83	84	85	86	85	85	84	83	81	EX6
	173	194	209	219	226	231	234	235	234	232	230	227	223	EX7
	463	517	556	584	604	616	623	625	624	620	613	604	594	EX8
+30	7	8	9	10	11	11	11	11	11	11	11	11	11	EX4
	20	25	28	30	32	33	34	34	34	34	34	34	33	EX5
	49	60	67	73	76	79	81	82	82	82	81	80	79	EX6
	133	164	184	199	210	217	221	224	225	224	223	221	217	EX7
	356	436	492	534	559	578	590	597	600	599	595	588	580	EX8
+25	3	6	8	9	9	10	10	11	11	11	11	11	11	EX4
	10	18	23	26	29	30	31	32	33	33	33	32	32	EX5
	23	121	152	137	188	198	206	210	213	214	213	212	210	EX6
	63	121	152	173	188	198	206	210	213	214	213	212	210	EX7
	169	322	406	462	501	529	548	560	567	570	569	565	559	EX8
+20		2	5	7	8	9	9	10	10	10	10	10	10	EX4
		5	16	21	25	27	28	29	30	31	31	31	31	EX5
		12	38	51	58	64	68	70	72	73	73	73	73	EX6
		34	105	139	160	175	186	193	197	200	201	201	199	EX7
		90	281	370	427	467	495	514	526	533	536	535	532	EX8
+15				4	6	7	8	9	9	9	9	9	9	EX4
				13	19	22	25	26	27	28	28	29	29	EX5
				32	45	53	59	62	65	67	68	68	68	EX6
				87	123	145	161	171	178	183	186	187	187	EX7
				231	328	388	428	456	475	488	495	498	498	EX8
+10					3	5	6	7	8	8	8	9	9	EX4
					9	16	20	22	24	25	26	26	26	EX5
					22	38	47	52	56	59	61	62	62	EX6
					61	104	128	144	155	162	167	170	171	EX7
					162	277	341	384	413	432	445	452	455	EX8

Application Expansion Valve and Liquid Injection Valve

Condensing Temperature °C	R22		Extended capacity (kW) Evaporating Temperature (°C)											Valve Type
	+15	+10	+5	0	-5	-10	-15	-20	-25	-30	-35	-40	-45	
+60	17	17	18	18	18	18	18	18	18	17	17	17	17	EX4
	51	52	53	54	54	54	54	54	53	53	52	52	51	EX5
	123	126	128	129	130	130	130	129	128	127	126	124	122	EX6
	337	345	351	355	357	358	357	356	353	350	345	340	335	EX7
	900	921	936	946	952	954	953	948	941	932	921	908	893	EX8
+55	16	17	17	18	18	18	18	18	18	18	17	17	17	EX4
	50	51	52	53	54	54	54	54	54	53	53	52	52	EX5
	119	123	126	128	129	130	130	130	129	128	127	126	124	EX6
	328	339	346	352	355	357	358	357	356	353	350	345	340	EX7
	876	903	923	938	948	953	955	953	949	941	932	921	908	EX8
+50	16	16	17	17	18	18	18	18	18	18	18	17	17	EX4
	48	50	51	52	53	54	54	54	54	54	53	53	52	EX5
	114	119	123	125	127	129	129	129	129	128	127	126	125	EX6
	314	327	337	345	350	354	355	356	355	353	351	347	343	EX7
	838	873	899	919	933	943	948	949	947	942	935	925	914	EX8
+45	15	16	16	17	17	17	17	18	18	18	17	17	17	EX4
	45	47	49	51	52	52	53	53	53	53	53	52	52	EX5
	107	113	118	121	124	126	127	128	128	127	127	126	124	EX6
	295	311	324	334	341	346	349	351	351	350	348	346	342	EX7
	787	830	864	890	909	923	932	936	937	934	929	922	912	EX8
+40	13	15	15	16	16	17	17	17	17	17	17	17	17	EX4
	41	44	46	48	50	51	52	52	52	52	52	52	51	EX5
	98	106	111	116	119	122	124	125	125	125	125	124	123	EX6
	270	290	306	319	328	335	340	343	345	345	344	342	339	EX7
	719	774	817	850	875	894	907	915	919	919	916	911	903	EX8
+35	12	13	14	15	16	16	16	17	17	17	17	17	17	EX4
	36	40	43	45	47	49	50	50	51	51	51	51	50	EX5
	86	96	103	109	113	117	119	121	122	122	122	122	121	EX6
	237	264	284	300	312	321	327	332	335	336	336	335	333	EX7
	632	703	757	799	831	856	873	885	893	896	896	893	888	EX8
+30	10	11	13	14	15	15	16	16	16	16	16	16	16	EX4
	29	35	39	42	44	46	47	48	49	49	49	49	49	EX5
	70	83	93	100	106	110	113	116	117	118	118	118	118	EX6
	194	229	256	276	291	303	312	318	322	325	326	326	324	EX7
	516	611	682	735	776	808	831	848	859	866	869	868	865	EX8
+25	7	9	11	12	13	14	15	15	15	16	16	16	16	EX4
	20	28	33	37	40	43	44	46	46	47	47	48	48	EX5
	47	67	80	90	97	102	106	109	112	113	114	114	114	EX6
	130	184	220	246	266	281	292	301	307	311	313	314	314	EX7
	347	491	587	656	709	749	779	802	818	829	835	837	836	EX8
+20		6	9	10	12	13	13	14	14	15	15	15	15	EX4
		18	26	32	36	39	41	42	44	45	45	45	46	EX5
		43	63	76	85	93	98	102	105	107	108	109	109	EX6
		117	173	209	235	254	269	280	288	294	298	300	300	EX7
		312	461	557	627	678	718	747	768	784	793	799	801	EX8
+15			5	8	10	11	12	13	13	14	14	14	14	EX4
			15	24	30	34	37	39	40	42	42	43	43	EX5
			37	58	71	81	88	93	97	100	102	103	104	EX6
			101	160	196	222	241	256	266	274	279	283	285	EX7
			269	426	524	593	644	682	710	731	745	754	759	EX8
+10				4	7	9	10	11	12	13	13	13	13	EX4
				12	22	28	31	34	36	38	39	40	40	EX5
				29	53	66	76	82	87	91	94	96	97	EX6
				80	145	182	208	227	241	251	258	263	267	EX7
				214	386	485	554	604	642	669	689	702	711	EX8

Application Expansion Valve and Liquid Injection Valve

Condensing Temperature °C	R404A / R507			Extended capacity (kW) Evaporating Temperature (°C)										Valve Type
	+15	10+	+5	0	-5	-10	-15	-20	-25	-30	-35	-40	-45	
+60	9	9	9	9	9	9	9	8	8	8	7	7	6	EX4
	28	28	28	28	28	27	26	25	24	23	22	21	20	EX5
	68	68	68	67	66	65	63	61	58	56	33	50	47	EX6
	186	187	186	184	181	177	172	166	160	153	145	137	129	EX7
	495	498	496	491	482	471	458	443	425	407	387	366	344	EX8
+55	10	10	10	10	10	10	10	9	9	9	8	8	8	EX4
	30	31	31	31	30	30	29	29	28	27	26	25	23	EX5
	72	73	74	74	73	72	70	69	67	64	62	59	56	EX6
	198	201	202	202	200	197	193	188	182	176	169	162	154	EX7
	527	535	538	537	533	525	514	501	486	470	451	432	411	EX8
+50	10	10	11	11	11	11	10	10	10	10	9	9	9	EX4
	31	32	32	32	32	32	32	31	30	30	29	28	27	EX5
	74	76	77	78	78	77	76	75	73	71	69	66	64	EX6
	203	208	211	213	219	211	208	204	200	194	188	181	174	EX7
	541	555	564	567	567	562	555	545	532	518	501	484	465	EX8
+45	10	10	11	11	11	11	11	11	11	10	10	10	9	EX4
	31	32	33	33	33	33	33	33	32	32	31	30	29	EX5
	74	77	79	80	80	80	80	79	78	76	74	72	69	EX6
	201	210	215	219	220	220	219	216	212	208	202	196	190	EX7
	537	559	574	583	587	586	582	575	566	553	539	524	506	EX8
+40	10	10	11	11	11	11	11	11	11	11	11	10	10	EX4
	29	31	33	33	34	34	34	34	34	34	33	32	31	EX5
	71	75	78	80	81	82	82	81	81	79	78	76	74	EX6
	193	205	214	219	223	225	225	223	221	217	213	208	202	EX7
	515	547	570	585	594	598	598	595	588	578	567	553	538	EX8
+35	9	10	10	11	11	11	11	11	11	11	11	11	11	EX4
	27	30	31	33	34	34	34	34	34	34	33	33	32	EX5
	65	71	75	79	81	82	83	83	82	81	80	79	77	EX6
	178	195	207	215	221	225	226	226	225	223	219	215	210	EX7
	474	519	551	574	590	599	603	604	600	594	585	573	560	EX8
+30	8	9	10	10	11	11	11	11	11	11	11	11	11	EX4
	23	27	30	31	33	34	34	34	34	34	34	33	33	EX5
	56	65	71	75	78	81	82	83	83	82	81	80	79	EX6
	153	177	194	206	215	221	224	226	226	225	223	219	215	EX7
	409	472	517	550	573	588	598	603	603	600	593	584	573	EX8
+25	6	8	9	10	10	11	11	11	11	11	11	11	11	EX4
	17	23	27	29	31	32	33	34	34	34	34	34	33	EX5
	42	55	64	70	74	78	80	81	82	82	81	80	79	EX6
	114	150	174	191	204	213	218	222	224	224	223	220	217	EX7
	305	400	465	510	543	566	582	592	596	597	593	587	579	EX8
+20	1	5	7	8	9	10	10	11	11	11	11	11	11	EX4
	3	16	22	26	28	30	32	33	33	33	33	33	33	EX5
	8	40	53	62	68	73	76	78	80	80	80	80	79	EX6
	21	108	146	170	187	200	208	214	218	219	220	218	216	EX7
	56	289	388	453	499	532	555	571	580	585	585	582	576	EX8
+15			5	7	8	9	10	10	10	11	11	11	11	EX4
			15	21	25	28	29	31	32	32	32	33	32	EX5
			37	51	60	66	71	74	76	77	78	78	78	EX6
			101	139	164	181	194	202	208	212	213	214	213	EX7
			268	371	437	484	516	540	555	564	569	569	566	EX8
+10				5	7	8	9	9	10	10	10	10	10	EX4
				14	20	24	26	28	30	31	31	31	31	EX5
				33	48	57	64	68	71	73	75	75	75	EX6
				91	131	156	174	186	195	201	204	206	206	EX7
				242	350	417	464	496	519	535	544	548	549	EX8

Application Expansion Valve and Liquid Injection Valve

Condensing Temperature °C		R407C		Extended capacity (kW) Evaporating Temperature (°C)											Valve Type
Dew Point	Bubble Point	+15	+10	+5	0	-5	-10	-15	-20	-25	-30	-35	-40	-45	
+64	+60	16	17	17	17	17	17	16	16	16	15	15	15	14	EX4
		50	51	51	51	51	50	50	49	48	47	46	45	43	EX5
		119	120	121	121	121	119	118	116	114	112	109	106	103	EX6
		328	332	333	333	332	329	325	320	314	308	301	293	285	EX7
		874	884	889	889	885	877	867	854	838	821	802	781	759	EX8
+59	+55	17	17	17	17	17	17	17	17	16	16	16	15	15	EX4
		50	51	52	52	52	52	51	51	50	49	48	47	46	EX5
		120	122	123	124	124	123	122	121	119	117	114	112	109	EX6
		330	336	339	341	341	339	336	332	328	322	315	308	301	EX7
		879	895	904	909	908	904	897	886	873	858	840	821	801	EX8
+54	+50	16	17	17	17	17	17	17	17	17	17	16	16	16	EX4
		50	51	52	52	53	53	52	52	51	51	50	49	48	EX5
		118	121	123	125	125	125	125	123	122	120	118	116	113	EX6
		326	334	340	343	345	345	343	340	336	331	325	319	312	EX7
		869	891	906	915	919	919	914	907	896	883	868	851	832	EX8
+50	+45	16	16	17	17	17	17	17	17	17	17	17	16	16	EX4
		48	50	51	52	53	53	53	52	52	51	51	50	49	EX5
		115	119	122	124	125	125	125	125	124	122	120	118	116	EX6
		316	327	336	341	344	346	345	344	341	337	332	326	320	EX7
		843	873	894	909	918	921	920	916	908	897	884	869	853	EX8
+45	+40	15	16	16	17	17	17	17	17	17	17	17	17	16	EX4
		46	48	50	51	52	52	52	52	52	52	51	50	49	EX5
		109	114	118	121	123	124	125	125	124	123	121	120	118	EX6
		300	315	326	334	339	342	344	343	341	338	334	330	324	EX7
		801	840	870	891	905	913	916	915	910	902	891	878	864	EX8
+40	+35	14	15	16	16	17	17	17	17	17	17	17	17	16	EX4
		42	45	48	49	50	51	52	52	52	51	51	50	50	EX5
		101	108	113	117	120	122	123	123	123	122	121	120	118	EX6
		278	297	312	323	330	335	338	339	338	337	334	330	325	EX7
		742	793	832	860	880	894	901	904	902	897	889	879	866	EX8
+35	+30	12	14	15	15	16	16	16	17	17	17	17	16	16	EX4
		38	42	45	47	48	49	50	51	51	51	50	50	49	EX5
		90	99	106	111	115	118	119	120	121	120	120	119	117	EX6
		248	273	292	306	317	324	329	331	332	331	329	326	323	EX7
		661	729	779	817	844	864	876	883	885	884	878	870	860	EX8
+30	+25	10	12	13	14	15	15	16	16	16	16	16	16	16	EX4
		32	37	41	44	46	47	48	49	49	49	49	49	48	EX5
		75	88	97	103	108	112	115	116	117	117	117	116	115	EX6
		207	241	266	285	299	309	316	320	322	323	322	320	317	EX7
		552	644	710	760	796	823	841	853	860	861	859	854	846	EX8
+26	+20	7	10	12	13	14	14	15	15	16	16	16	16	15	EX4
		23	30	36	39	42	44	46	47	47	48	48	48	47	EX5
		54	72	85	94	100	105	108	111	112	113	113	113	112	EX6
		148	199	233	258	276	289	299	305	309	312	312	311	309	EX7
		395	530	621	687	735	770	796	814	825	831	832	829	824	EX8
+21	+15		7	9	11	12	13	14	14	15	15	15	15	15	EX4
			21	29	34	38	40	42	44	45	45	46	46	46	EX5
			50	69	81	90	96	101	104	106	108	108	108	108	EX6
			137	189	223	247	265	277	287	293	297	299	299	298	EX7
			365	503	594	658	705	740	764	781	791	796	796	795	EX8
+16	+10			6	9	11	12	13	13	14	14	14	14	14	EX4
				19	27	32	36	38	40	42	43	43	43	43	EX5
				45	64	76	85	91	96	99	101	103	103	103	EX6
				123	176	210	234	251	264	273	279	282	282	284	EX7
				329	470	561	624	670	704	727	743	753	753	758	EX8

Application Expansion Valve and Liquid Injection Valve

Condensing Temperature °C	R410A		Extended capacity (kW) Evaporating Temperature (°C)											Valve Type
	+15	+10	+5	0	-5	-10	-15	-20	18	-30	-35	-40	-45	
+60	17	17	18	18	18	18	18	18	18	18	17	17	17	EX4
	51	52	53	54	54	54	54	54	53	53	52	51	50	EX5
	123	126	129	130	131	131	131	130	129	127	125	123	120	EX6
	339	348	354	358	360	361	360	358	354	350	344	338	331	EX7
	-	-	-	-	-	-	-	-	-	-	-	-	-	EX8
+55	18	18	19	19	19	19	19	19	19	19	19	18	18	EX4
	53	55	56	57	57	58	58	58	57	57	56	55	54	EX5
	127	132	135	137	138	139	139	139	138	137	135	133	131	EX6
	350	362	370	377	381	383	383	382	380	377	372	366	360	EX7
	935	965	988	1005	1016	1021	1023	1020	1014	1005	992	978	961	EX8
+50	18	18	19	19	20	20	20	20	20	20	20	19	19	EX4
	53	55	57	58	59	60	60	60	60	59	59	58	57	EX5
	128	133	137	140	142	144	145	145	144	143	142	140	138	EX6
	351	366	377	386	392	396	398	398	397	394	391	386	380	EX7
	936	975	1006	1029	1045	1056	1061	1062	1059	1052	1043	1030	1015	EX8
+45	17	18	19	19	20	20	20	20	20	20	20	20	20	EX4
	52	54	57	58	60	60	61	61	61	61	61	60	59	EX5
	124	131	136	141	144	146	147	148	148	147	146	145	143	EX6
	342	361	375	387	395	401	405	407	407	405	403	399	394	EX7
	913	962	1001	1031	1054	1070	1080	1085	1085	1082	1075	1064	1052	EX8
+40	16	17	18	19	20	20	20	21	21	21	21	20	20	EX4
	49	52	55	57	59	60	61	62	62	62	62	61	61	EX5
	118	126	133	138	142	145	147	149	149	149	149	148	146	EX6
	324	348	366	381	392	400	406	409	411	411	409	406	402	EX7
	864	927	977	1015	1045	1067	1082	1091	1095	1095	1091	1084	1073	EX8
+35	15	16	18	18	19	20	20	20	21	21	21	20	20	EX4
	45	49	53	55	58	59	60	61	62	62	62	62	61	EX5
	108	118	127	134	139	143	146	148	149	149	149	149	148	EX6
	296	326	349	368	382	393	401	406	409	411	410	409	406	EX7
	789	869	932	981	1019	1048	1069	1083	1092	1095	1095	1090	1082	EX8
+30	13	15	16	17	18	19	20	20	20	20	20	20	20	EX4
	38	44	49	52	55	57	59	60	61	61	61	61	61	EX5
	93	107	118	126	133	138	142	145	147	148	148	148	147	EX6
	255	294	325	348	366	380	390	398	403	406	407	406	405	EX7
	680	786	866	928	976	1013	1041	1061	1075	1083	1086	1084	1079	EX8
+25	10	13	15	16	17	18	19	19	20	20	20	20	20	EX4
	29	38	44	48	52	54	56	58	59	60	60	60	60	EX5
	71	91	106	117	125	131	136	140	143	144	145	146	145	EX6
	195	251	291	321	344	361	375	385	392	397	399	400	399	EX7
	520	669	775	855	916	964	1000	1027	1046	1058	1065	1067	1065	EX8
+20	4	9	12	14	16	17	18	18	19	19	19	20	20	EX4
	13	28	37	43	47	51	53	55	57	58	58	59	59	EX5
	31	68	89	103	114	122	129	133	137	139	141	142	142	EX6
	84	188	244	284	314	337	354	367	377	383	388	390	390	EX7
	225	501	652	758	837	898	944	979	1005	1023	1034	1040	1042	EX8
+15		3	9	12	14	15	16	17	18	18	19	19	19	EX4
		10	27	36	42	46	49	52	54	55	56	57	57	EX5
		23	65	86	100	111	119	125	130	133	135	137	137	EX6
		64	178	236	276	305	327	344	357	366	372	376	378	EX7
		172	475	629	735	813	873	917	951	976	992	1003	1008	EX8
+10			1	8	11	13	15	16	17	17	18	18	18	EX4
			4	25	34	40	44	47	50	52	53	54	55	EX5
			10	60	82	96	107	115	121	125	128	130	132	EX6
			28	166	225	265	294	315	332	344	352	358	362	EX7
			76	443	600	706	783	841	885	917	940	956	965	EX8

Application Expansion Valve and Liquid Injection Valve

Condensing Temperature °C	R124		Extended capacity (kW) Evaporating Temperature (°C)					Valve Type
	+30	+25	+20	+15	+10	+5	0	
+100	7	7	7	6	6	6	5	EX4
	22	21	20	19	18	17	16	EX5
	53	51	49	47	44	42	39	EX6
+95	8	8	7	7	7	7	6	EX4
	24	23	23	22	21	20	19	EX5
	57	56	54	52	50	47	45	EX6
+90	8	8	8	8	7	7	7	EX4
	25	25	24	24	23	22	21	EX5
	61	59	58	56	54	52	50	EX6
+85	9	9	8	8	8	8	7	EX4
	26	26	25	25	24	23	23	EX5
	63	62	61	60	58	56	54	EX6
+80	9	9	9	8	8	8	8	EX4
	27	27	26	26	25	25	24	EX5
	64	63	63	62	61	59	57	EX6
+75	9	9	9	9	9	8	8	EX4
	27	27	27	26	26	25	25	EX5
	64	64	64	63	62	61	60	EX6
+70	9	9	9	9	9	9	8	EX4
	26	26	27	27	26	26	25	EX5
	62	63	64	63	63	62	61	EX6
+65	8	8	9	9	9	9	8	EX4
	25	26	26	26	26	26	26	EX5
	60	61	62	63	63	62	62	EX6
+60	8	8	8	8	8	8	8	EX4
	23	24	25	26	26	26	26	EX5
	56	58	60	61	62	62	61	EX6

Condensing Temperature °C	R23		Extended capacity (kW) Evaporating Temperature (°C)										Valve Type
	-45	-50	-55	-60	-65	-70	-75	-80	-85	-90	-95	-100	
-10	17	18	19	19	19	19	19	19	19	19	19	18	EX4
	53	55	56	57	58	58	58	58	58	57	57	56	EX5
	127	132	135	138	139	140	140	140	139	138	137	135	EX6
-15	16	17	18	18	19	19	19	19	19	19	18	18	EX4
	50	52	54	55	56	57	57	57	57	57	56	55	EX5
	119	125	130	133	135	137	137	137	137	136	135	134	EX6
-20	15	16	17	17	18	18	18	18	18	18	18	18	EX4
	45	48	51	53	54	55	55	55	55	55	55	54	EX5
	109	117	122	127	130	132	133	134	133	133	132	131	EX6
-25	13	14	15	16	17	17	17	18	18	18	18	17	EX4
	40	44	47	49	51	52	53	53	53	53	53	53	EX5
	96	106	113	118	122	125	127	128	129	128	128	127	EX6
-30	11	13	14	15	16	16	16	17	17	17	17	17	EX4
	33	38	42	45	47	49	50	51	51	51	51	51	EX5
	78	92	101	108	114	117	120	122	122	123	123	122	EX6
-35	7	10	12	13	14	15	15	16	16	16	16	16	EX4
	22	30	36	40	43	45	46	47	48	48	48	48	EX5
	53	73	86	96	103	108	111	114	115	116	116	116	EX6
-40		6	9	11	12	13	14	14	15	15	15	15	EX4
		19	28	33	37	40	42	43	44	45	45	45	EX5
		46	67	80	90	96	101	104	106	108	108	108	EX6
-45			5	8	10	11	12	13	13	13	14	14	EX4
			15	25	30	34	37	39	40	41	41	41	EX5
			37	60	73	82	88	93	96	98	99	100	EX6

Application Expansion Valve and Liquid Injection Valve

Condensing Temperature °C	R744		Extended capacity (kW) Evaporating Temperature (°C)											Valve Type
	+8	+5	0	-5	-10	-15	-20	-25	-30	-35	-40	-45	-50	
+10	5	12	18	22	26	29	31	33	34	35	36	37	38	EX4
	15	36	55	68	79	87	94	99	104	108	110	113	114	EX5
	36	86	132	164	189	208	225	238	249	257	264	269	273	EX6
	99	237	362	450	518	572	617	653	683	707	726	740	750	EX7
	-	-	-	-	-	-	-	-	-	-	-	-	-	-
+5			12	19	23	27	29	32	33	35	36	37	38	EX4
			37	57	71	81	90	96	102	106	110	113	115	EX5
			89	137	170	195	215	231	244	254	263	269	274	EX6
			244	376	466	535	589	634	670	699	722	739	753	EX7
			-	-	-	-	-	-	-	-	-	-	-	-
0				12	19	24	27	30	32	34	35	36	37	EX4
				38	58	72	83	91	98	103	107	111	113	EX5
				90	139	173	198	218	234	247	257	265	271	EX6
				247	383	475	544	598	642	677	705	727	744	EX7
				659	1023	1267	1452	1598	1715	1809	1883	1942	1987	EX8
-5					12	19	24	27	30	32	34	35	36	EX4
					97	59	73	83	91	98	103	107	110	EX5
					89	140	174	199	219	234	247	257	264	EX6
					245	385	477	547	601	644	678	705	725	EX7
					654	1028	1275	1460	1604	1718	1809	1881	1937	EX8
-10						12	19	24	27	30	32	34	35	EX4
						36	58	72	83	91	97	102	106	EX5
						87	139	173	198	217	233	245	254	EX6
						239	382	475	544	597	639	671	697	EX7
						639	1021	1269	1452	1594	1705	1793	1861	EX8
-15							11	19	23	27	29	31	33	EX4
							35	57	71	82	89	96	100	EX5
							84	137	171	195	214	229	240	EX6
							229	376	468	536	588	628	660	EX7
							613	1003	1250	1431	1570	1677	1761	EX8
-20								11	18	23	26	29	31	EX4
								33	56	70	80	87	93	EX5
								79	133	166	191	209	223	EX6
								216	365	457	523	574	613	EX7
								576	974	1220	1398	1532	1636	EX8
-25									10	18	22	25	28	EX4
									30	53	67	77	85	EX5
									72	128	161	185	202	EX6
									198	350	442	507	556	EX7
									528	935	1179	1353	1483	EX8
-30										9	17	21	24	EX4
										27	51	64	74	EX5
										64	121	154	177	EX6
										175	332	423	486	EX7
										466	887	1129	1298	EX8
-35											7	16	20	EX4
											22	47	61	EX5
											53	113	146	EX6
											145	310	400	EX7
											386	828	1068	EX8
-40												5	14	EX4
												16	43	EX5
												37	103	EX6
												103	284	EX7
												275	759	EX8

For Applications As Expansion Valve The Following Correction Factors (k_c) Related To Evaporating And Condensing Temperatures Apply

R407F		Correction factors for EXV													
		Evaporating temperature °C													
		+20	+15	+10	+5	0	-5	-10	-15	-20	-25	-30	-35	-40	-45
Liquid temperature °C	+65	1.51	1.53	1.55	1.58	1.61	1.64	1.68	1.71	1.75	1.80	1.85	1.90	1.96	2.02
	+60	1.35	1.37	1.39	1.41	1.43	1.46	1.49	1.52	1.55	1.59	1.63	1.67	1.71	1.76
	+55	1.23	1.25	1.26	1.28	1.30	1.32	1.35	1.37	1.40	1.43	1.46	1.50	1.53	1.57
	+50	1.14	1.15	1.16	1.18	1.20	1.22	1.24	1.26	1.28	1.31	1.33	1.36	1.39	1.43
	+45	1.06	1.07	1.08	1.10	1.11	1.13	1.14	1.16	1.18	1.20	1.23	1.25	1.28	1.31
	+40	0.99	1.00	1.01	1.02	1.04	1.05	1.07	1.08	1.10	1.12	1.14	1.16	1.18	1.21
	+35	0.93	0.94	0.95	0.96	0.97	0.99	1.00	1.01	1.03	1.05	1.06	1.08	1.10	1.13
	+30	0.88	0.89	0.90	0.91	0.92	0.93	0.94	0.95	0.97	0.98	1.00	1.02	1.03	1.05
	+25	0.83	0.84	0.85	0.86	0.87	0.88	0.89	0.90	0.91	0.93	0.94	0.96	0.97	0.99
	+20	0.79	0.80	0.81	0.82	0.82	0.83	0.84	0.85	0.87	0.88	0.89	0.91	0.92	0.94
	+15	0.76	0.76	0.77	0.78	0.78	0.79	0.80	0.81	0.82	0.83	0.85	0.86	0.87	0.89
	+10	0.72	0.73	0.74	0.74	0.75	0.76	0.77	0.77	0.78	0.79	0.81	0.82	0.83	0.84
	+5	0.69	0.70	0.70	0.71	0.72	0.72	0.73	0.74	0.75	0.76	0.77	0.78	0.79	0.80
	0	0.66	0.67	0.68	0.68	0.69	0.69	0.70	0.71	0.72	0.73	0.73	0.74	0.75	0.77
	-5	0.64	0.64	0.65	0.65	0.66	0.67	0.67	0.68	0.69	0.70	0.70	0.71	0.72	0.73
	-10	0.62	0.62	0.62	0.63	0.63	0.64	0.65	0.65	0.66	0.67	0.68	0.68	0.69	0.70

For Applications As Expansion Valve The Following Correction Factors ($k_{\Delta P}$) Related To The Pressure Drop At Valve Apply

		Correction factors for EXVs													
ΔP (bar)	1	1.5	2	2.5	3	3.5	4	4.5	5	5.5	6	6.5	7	7.5	
$k_{\Delta P}$	3.51	2.87	2.48	2.22	2.03	1.88	1.76	1.66	1.57	1.5	1.43	1.38	1.33	1.28	
ΔP (bar)	8	9	10	11	12	13	14	15	16	17	18	19	20	21	
$k_{\Delta P}$	1.24	1.17	1.11	1.06	1.01	0.97	0.94	0.91	0.88	0.85	0.83	0.81	0.79	0.77	

Application Hot Gas Bypass - Nominal Capacities (kW)

Valve Type	Kv, m ³ /h	R22 / R407C	R134a	R404A / R507
EX4	0.21	4.9	3.4	4.6
EX5	0.68	16	11	15
EX6	1.57	37	26	35
EX7	5.58	131	92	126
EX8	16.95	399	278	382

The nominal capacity (Qn) is based on the following conditions:

Refrigerant	Evaporating temperature	Condensing temperature	Subcooling
R407C	+4°C (dew point)	+38°C bubble point / +43°C dew point	1K
R22, R134a, R404A, R507	+4°C	+38°C	1K

For other operating conditions use Excel-based Selection Tool (download from www.emersonclimate.eu) or use the following quick selection tables.

Biflow versions are not released for hot gas bypass applications. EX4 .. EX8 must be installed with motor downward in hot gas line applications. This ensures the valve life expectancy. Install a check valve on main hot gas line just after branch to Control Valve.

Condensing Temperature °C	Extended Capacity kW			Valve type
	R22 / R407C	R134a	R404A / R507	
60 bubble point for all refrig. (64 dew point for R407C)	7	4.9	5.8	EX4
	23	16	19	EX5
	54	38	45	EX6
	191	135	161	EX7
	581	411	488	EX8
50 bubble point for all refrig. (54 dew point for R407C)	6.1	4.3	5.5	EX4
	20	14	18	EX5
	46	32	41	EX6
	163	115	147	EX7
	495	348	447	EX8
40 bubble point for all refrig. (45 dew point for R407C)	4.9	3.7	4.9	EX4
	16	12	16	EX5
	38	27	36	EX6
	136	95	130	EX7
	414	289	394	EX8
30 bubble point for all refrig. (35 dew point for R407C)	4.3	2.8	4	EX4
	14	9	13	EX5
	32	22	31	EX6
	112	78	111	EX7
	340	236	336	EX8

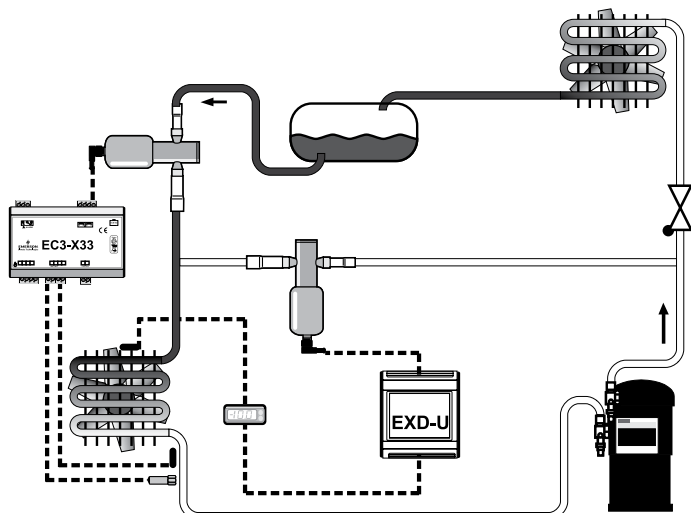

Application Suction Pressure Regulation (Evaporating or Crankcase Pressure) - Nominal Capacities (kW)

Valve Type	Kv, m ³ /h	R407C	R22	R134a	R404A
EX6	1.57	3.9	4.1	3.1	3.5
EX7	5.58	14	15	11	13
EX8	16.95	42	45	34	38

The nominal capacity (Qn) is based on the following conditions:

Refrigerant	Evaporating temperature	Condensing temperature	Subcooling	Pressure Drop
R407C	+4°C (dew point)	+38°C bubble point / +43°C dew point	1K	0.15 bar
R22, R134a, R404A	+4°C	+38°C	1K	0.15 bar

For other operating conditions use Excel-based Selection Tool (download from www.emersonclimate.eu) or use the following quick selection tables.

For biflow versions attention should be paid to the temperature range T5 -40°C to +80°C! The EX6 .. EX8 must be installed with motor downward in suction line applications. This ensures the valve life expectancy.

Example:

The EX6 provides 3.5 kW at 0.15 bar pressure drop with R404A or $3.5 * 1.41 = 4.9$ kW at 0.3 bar pressure drop.

Multiply above nominal capacities by following factors to obtain capacities at different pressure drops:

Typical Order Package

- 1) Valve EX6, EX7 or EX8
Plug and cable assembly EXV-M60
- 2) Controller Kit EXD-U01 Part No. 804 750

ΔP, bar	0.10	0.15	0.20	0.30
Correction factor	0.82	1.00	1.15	1.41

Condensing Temperature °C	R134a					Valve Type
	Extended capacity (kW) Evaporating Temperature (°C)					
	+10	+5	0	-10	-20	
+60	3	2	2	2	1	EX6
	10	9	8	6	4	EX7
	30	27	24	18	13	EX8
+50	3	3	2	2	1	EX6
	11	10	9	7	5	EX7
	34	30	27	21	15	EX8
+40	3	3	3	2	2	EX6
	12	11	10	8	6	EX7
	38	34	30	23	17	EX8
+30	4	3	3	2	2	EX6
	14	12	11	8	6	EX7
	41	37	33	26	19	EX8
+20	4	4	3	3	2	EX6
	15	13	12	9	7	EX7
	45	40	36	28	21	EX8

Condensing Temperature °C	R22							Valve Type
	Extended capacity (kW) Evaporating Temperature (°C)							
	+10	+5	0	-10	-20	-30	-40	
+60	4	3	3	3	2	2	1	EX6
	13	12	11	9	7	5	4	EX7
	41	37	34	27	22	17	12	EX8
+50	4	4	3	3	2	2	1	EX6
	15	13	12	10	8	6	5	EX7
	45	41	37	30	24	19	14	EX8
+40	5	4	4	3	2	2	1	EX6
	16	15	13	11	9	7	5	EX7
	49	45	41	33	27	21	15	EX8
+30	5	4	4	3	3	2	2	EX6
	17	16	14	12	9	7	5	EX7
	53	48	44	36	29	22	16	EX8
+20	5	5	4	4	3	2	2	EX6
	19	17	15	13	10	8	6	EX7
	56	52	47	39	31	24	18	EX8

Application Suction Pressure Regulation (Evaporating or Crankcase Pressure)

Condensing Temperature °C	R404A/R507							Valve Type
	Extended capacity (kW) Evaporating Temperature (°C)							
	+10	+5	0	-10	-20	-30	-40	
+60	3	2	2	2	1	1	1	EX6
	9	8	8	6	4	3	2	EX7
	29	26	23	18	13	10	7	EX8
+50	3	3	3	2	2	1	1	EX6
	12	11	9	7	6	4	3	EX7
	36	32	29	23	18	13	9	EX8
+40	4	3	3	3	2	1	1	EX6
	14	12	11	9	7	5	4	EX7
	42	38	34	27	21	16	12	EX8
+30	4	4	4	3	2	2	1	EX6
	16	14	13	10	8	6	5	EX7
	48	43	39	31	25	19	14	EX8
+20	5	4	4	3	3	2	1	EX6
	17	16	14	12	9	7	5	EX7
	53	48	44	35	28	21	16	EX8

Condensing Temperature		R407C	Extended capacity (kW)					Valve Type
Dew point °C	Bubble point °C		Evaporating Temperature (°C)					
		+10	+5	0	-10	-20		
+64	+60	3	3	3	2	2	EX6	
		12	11	10	8	6	EX7	
		36	33	29	23	18	EX8	
+54	+50	4	3	3	2	2	EX6	
		14	12	11	9	7	EX7	
		41	37	34	27	21	EX8	
+45	+40	4	4	3	3	2	EX6	
		15	14	12	10	8	EX7	
		46	42	38	30	23	EX8	
+35	+30	5	4	4	3	2	EX6	
		17	15	14	11	9	EX7	
		51	46	41	33	26	EX8	
+26	+20	5	5	4	3	3	EX6	
		18	16	15	12	9	EX7	
		55	50	45	36	28	EX8	

Application Condensing Pressure Regulation and Liquid Duty - Nominal Capacities (kW)

Valve Type	Kv, m ³ /h	R407C	R22	R134a	R404A
EX5	0.68	18	20	18	13
EX6	1.57	43	46	42	30
EX7	5.58	153	162	151	106
EX8	16.95	463	491	458	323

The nominal capacity (Qn) is based on the following conditions:

Refrigerant	Evaporating temperature	Condensing temperature	Subcooling	Pressure Drop
R407C	+4°C (dew point)	+38°C bubble point / +43°C dew point	1K	0.35 bar
R22, R134a, R404A	+4°C	+38°C	1K	0.35 bar

Multiply above nominal capacities by following factors to obtain capacities at different pressure drops:

ΔP, bar	0.15	0.20	0.35
Correction factor	0.65	0.76	1.00

Example:

The EX6 provides 30kW at 0.35bar pressure drop with R404A or $30 \times 0.76 = 22.8$ kW at 0.2 bar pressure drop.

Condensing Temperature °C	R134a		Extended Capacity Evaporating Temperature (°C)				Valve type
	+10	0	-10	-20	-30	-40	
+60	14	13	13	12			EX5
	32	31	29	27			EX6
	115	109	104	98			EX7
	350	332	315	296			EX8
+50	16	15	15	14			EX5
	37	36	34	32			EX6
	133	127	121	115			EX7
	405	387	369	350			EX8
+30	18	18	17	16			EX5
	42	41	39	37			EX6
	151	145	139	133			EX7
	458	440	422	403			EX8
+40	20	20	19	18			EX5
	47	46	44	42			EX6
	168	162	156	150			EX7
	512	493	474	455			EX8
+20	22	22	21	20			EX5
	52	51	49	47			EX6
	186	180	173	167			EX7
	564	546	526	507			EX8

Condensing Temperature °C	R22		Extended Capacity Evaporating Temperature (°C)				Valve type
	+10	0	-10	-20	-30	-40	
+60	15	15	15	14	14	13	EX5
	36	35	34	33	32	30	EX6
	128	124	120	116	112	108	EX7
	387	377	365	353	341	328	EX8
+50	17	17	16	17	16	15	EX5
	41	40	36	39	36	35	EX6
	144	141	129	137	129	124	EX7
	439	428	391	416	391	377	EX8
+30	19	19	19	18	17	17	EX5
	45	44	43	42	41	39	EX6
	161	157	153	149	145	140	EX7
	488	477	465	453	439	426	EX8
+40	21	21	20	20	19	19	EX5
	50	49	48	46	45	44	EX6
	177	173	169	165	160	156	EX7
	536	525	513	500	486	472	EX8
+20	23	23	22	22	21	21	EX5
	54	53	52	51	49	48	EX6
	192	188	184	180	175	171	EX7
	584	572	560	547	533	519	EX8

Application Condensing Pressure Regulation and Liquid Duty

Condensing Temperature °C	R404A/507		Evaporating Temperature (°C)				Valve type
	+10	0	-10	-20	-30	-40	
+60	8	8	7	6	6	5	EX5
	19	17	16	15	13	12	EX6
	66	62	58	53	48	43	EX7
	202	189	175	160	146	130	EX8
+50	11	10	9	9	8	8	EX5
	24	23	22	20	19	17	EX6
	87	82	78	73	67	62	EX7
	264	250	236	220	205	189	EX8
+30	13	12	12	11	10	10	EX5
	30	28	27	26	24	23	EX6
	106	101	96	91	85	80	EX7
	321	306	291	276	260	243	EX8
+40	15	14	14	13	12	12	EX5
	35	33	32	30	29	27	EX6
	123	119	114	108	103	97	EX7
	375	360	345	329	312	295	EX8
+20	17	16	16	15	14	14	EX5
	40	38	37	35	34	32	EX6
	141	136	131	125	120	114	EX7
	427	412	397	380	363	346	EX8

Condensing Temperature		R407C	Evaporating Temperature (°C)		Valve type	
Dew Point °C	Dew Point °C		+10	0		
+64	+60	14	13	12	12	EX5
		32	30	29	28	EX6
		112	108	103	98	EX7
		340	327	313	298	EX8
+54	+50	16	15	15	14	EX5
		37	36	35	33	EX6
		132	128	123	118	EX7
		402	388	373	358	EX8
+45	+40	18	18	17	17	EX5
		43	41	40	38	EX6
		152	147	142	137	EX7
		460	446	431	415	EX8
+35	+30	21	20	19	19	EX5
		48	47	45	44	EX6
		170	166	160	155	EX7
		517	503	487	471	EX8
+26	+20	23	22	22	21	EX5
		53	52	50	49	EX6
		189	184	179	173	EX7
		573	558	543	526	EX8

Application Hot Gas Flow such as Heat Reclaim Application - Nominal Capacities (kW)

Valve Type	Kv, m ³ /h	R22 / R407C	R134a	R404A / R507	R410A
EX6	1.57	11	9	10	13
EX7	5.58	39	33	36	47
EX8	16.95	119	101	108	144

The nominal capacity (Qn) is based on the following conditions:

Refrigerant	Evaporating temperature	Condensing temperature	Subcooling	Pressure Drop	Isentropic Efficiency
R407C	+4°C (dew point)	+38°C bubble point / +43°C dew point	1K	0.35 bar	80%
R22, R134a, R404A, R507	+4°C	+38°C	1K	0.35 bar	80%

For other conditions see following tables.

Valves must be installed with motor downward in hot gas line applications. This ensures the valve life expectancy. Bi-flow versions are not released for hot gas flow applications.

Condensing Temperature °C	Pressure Drop bar	R134a		Extended Capacity KW Evaporating Temperature (°C)											Valve type	
		+15	+10	+5	0	-5	-10	-15	-20	-25	-30	-35	-40	-45		
+60	0.1	5	5	4	4	4	4	4	4	4	4	3	3	3	3	EX6
		16	16	16	15	15	14	14	14	13	13	12	12	11	10	EX7
		50	49	47	46	44	43	41	40	38	37	35	33	32	EX8	
	0.5	10	10	10	9	9	9	8	8	8	7	7	7	6	EX6	
		36	35	34	33	32	31	30	29	28	26	25	24	23	EX7	
		110	107	104	101	97	94	91	87	84	80	77	74	70	EX8	
	1.0	14	14	13	13	12	12	12	11	11	10	10	9	9	EX6	
		50	49	47	46	44	43	41	40	38	37	35	34	32	EX7	
		152	148	144	139	135	130	126	121	116	112	107	102	97	EX8	
+50	0.1	5	4	4	4	4	4	4	4	4	3	3	3	3	EX6	
		16	16	15	15	14	14	14	13	13	12	12	11	11	EX7	
		49	48	47	45	44	43	41	40	39	37	36	35	33	EX8	
	0.5	10	10	9	9	9	9	8	8	8	8	7	7	7	EX6	
		35	35	34	33	32	31	30	29	28	27	26	25	24	EX7	
		108	105	102	99	97	94	91	88	85	82	79	76	73	EX8	
	1.0	14	13	13	13	12	12	12	11	11	10	10	10	9	EX6	
		49	48	46	45	44	43	41	40	39	37	36	34	33	EX7	
		148	145	141	137	133	129	125	121	117	113	109	105	100	EX8	
+40	0.1	4	4	4	4	4	4	4	4	4	3	3	3	3	EX6	
		16	15	15	14	14	14	13	13	13	12	12	11	11	EX7	
		47	46	45	44	43	42	40	39	38	37	36	34	33	EX8	
	0.5	10	9	9	9	9	8	8	8	8	7	7	7	7	EX6	
		34	33	32	32	31	30	29	28	27	26	26	25	24	EX7	
		103	100	98	96	93	91	88	86	83	80	78	75	73	EX8	
	1.0	13	13	12	12	12	12	11	11	11	10	10	10	9	EX6	
		46	45	44	43	42	41	40	39	38	36	35	34	33	EX7	
		141	138	134	131	128	124	121	117	114	110	107	103	100	EX8	
+30	0.1	4	4	4	4	4	4	4	3	3	3	3	3	3	EX6	
		15	14	14	14	13	13	13	12	12	12	11	11	11	EX7	
		44	43	42	42	41	40	39	38	37	35	34	33	32	EX8	
	0.5	9	9	9	8	8	8	8	8	7	7	7	7	6	EX6	
		32	31	30	30	29	28	28	27	26	25	25	24	23	EX7	
		96	94	92	90	88	86	84	81	79	77	75	72	70	EX8	
	1.0	12	12	12	11	11	11	11	10	10	10	9	9	9	EX6	
		43	42	41	40	39	38	37	36	35	34	33	32	31	EX7	
		130	128	125	122	119	117	114	111	108	105	102	98	95	EX8	

Application Hot Gas Flow such as Heat Reclaim Application

Condensing Temperature °C	Pressure Drop bar	R22/R407C		Extended Capacity KW Evaporating Temperature (°C)											Valve type
		+15	+10	+5	0	-5	-10	-15	-20	-25	-30	-35	-40	-45	
+60	0.1	6	5	5	5	5	5	5	5	4	4	4	4	4	EX6
		20	19	19	18	18	17	17	16	16	15	15	14	14	EX7
		59	58	57	55	54	53	51	50	48	47	45	44	42	EX8
	0.5	12	12	12	11	11	11	10	10	10	10	9	9	9	EX6
		43	42	41	40	39	38	37	36	35	34	33	32	31	EX7
		131	129	126	123	119	116	113	110	107	103	100	97	94	EX8
	1.0	17	17	16	16	15	15	15	14	14	13	13	13	12	EX6
		60	59	58	56	55	53	52	51	49	48	46	45	43	EX7
		183	179	175	171	167	162	158	154	149	145	140	135	131	EX8
+50	0.1	5	5	5	5	5	5	5	5	4	4	4	4	4	EX6
		19	19	18	18	17	17	17	16	16	15	15	14	14	EX7
		58	57	56	54	53	52	51	49	48	47	45	44	42	EX8
	0.5	12	12	11	11	11	11	10	10	10	10	9	9	9	EX6
		42	41	40	40	39	38	37	36	35	34	33	32	31	EX7
		128	126	123	120	117	115	112	109	106	103	100	97	94	EX8
	1.0	17	16	16	15	15	15	14	14	14	13	13	13	12	EX6
		59	57	56	55	54	52	51	50	49	47	46	44	43	EX7
		178	175	171	167	163	159	155	151	147	143	139	135	131	EX8
+40	0.1	5	5	5	5	5	5	5	4	4	4	4	4	4	EX6
		18	18	18	17	17	16	16	16	15	15	15	14	14	EX7
		56	55	54	52	51	50	49	48	47	45	44	43	42	EX8
	0.5	11	11	11	11	10	10	10	10	9	9	9	9	8	EX6
		40	40	39	38	37	36	35	35	34	33	32	31	30	EX7
		123	120	118	115	113	110	108	105	103	100	97	94	92	EX8
	1.0	16	15	15	15	14	14	14	14	13	13	12	12	12	EX6
		56	55	54	53	52	50	49	48	47	46	44	43	42	EX7
		170	167	163	160	157	153	149	146	142	139	135	131	127	EX8
+30	0.1	5	5	5	5	4	4	4	4	4	4	4	4	4	EX6
		17	17	17	16	16	16	15	15	15	14	14	14	13	EX7
		53	52	51	50	49	48	46	45	44	43	42	41	40	EX8
	0.5	11	10	10	10	10	10	9	9	9	9	9	8	8	EX6
		38	37	37	36	35	34	34	33	32	31	30	30	29	EX7
		115	113	111	109	107	104	102	100	97	95	93	90	88	EX8
	1.0	15	14	14	14	14	13	13	13	12	12	12	12	11	EX6
		52	51	50	49	48	47	46	45	44	43	42	41	40	EX7
		159	156	153	150	147	144	141	138	134	131	128	124	121	EX8

* Condensing temperatures R407C:

The relation between bubble points and dew points is as follows:

Bubble point °C	Dew point °C
+60	+64
+50	+54
+40	+45
+30	+35

Application Hot Gas Flow such as Heat Reclaim Application

Condensing Temperature °C	Pressure Drop bar	R404A		Extended Capacity KW Evaporating Temperature (°C)											Valve type
		+15	+10	+5	0	-5	-10	-15	-20	-25	-30	-35	-40	-45	
+60	0.1	4	4	4	4	4	3	3	3	3	3	3	2	2	EX6
		15	14	14	13	13	12	11	11	10	10	9	8	8	EX7
		45	43	42	40	38	36	35	33	31	29	27	25	23	EX8
	0.5	9	9	8	8	8	7	7	7	6	6	6	5	5	EX6
		32	31	30	29	28	26	25	24	22	21	20	18	17	EX7
		99	95	92	88	84	80	76	72	68	64	60	56	52	EX8
	1.0	13	12	12	11	11	10	10	9	9	8	8	7	7	EX6
		45	44	42	40	39	37	35	33	31	29	27	26	24	EX7
		137	132	127	122	117	112	106	101	95	89	84	78	72	EX8
+50	0.1	5	4	4	4	4	4	4	4	3	3	3	3	3	EX6
		16	16	15	15	14	14	13	13	12	11	11	10	10	EX7
		49	47	46	44	43	41	40	38	36	35	33	31	30	EX8
	0.5	10	10	9	9	9	8	8	8	7	7	7	6	6	EX6
		35	34	33	32	31	30	29	28	26	25	24	23	22	EX7
		107	104	101	98	95	91	88	84	80	77	73	69	65	EX8
	1.0	14	13	13	13	12	12	11	11	10	10	9	9	8	EX6
		49	48	46	45	43	42	40	38	37	35	33	32	30	EX7
		149	145	141	136	131	127	122	117	112	107	102	96	91	EX8
+40	0.1	5	4	4	4	4	4	4	4	4	3	3	3	3	EX6
		16	16	16	15	15	14	14	13	13	12	12	11	11	EX7
		50	49	47	46	45	43	42	40	39	37	36	34	33	EX8
	0.5	10	10	10	9	9	9	9	8	8	8	7	7	7	EX6
		36	35	34	33	32	31	30	29	28	27	26	25	24	EX7
		109	107	104	101	98	95	92	89	86	83	79	76	73	EX8
	1.0	14	14	13	13	13	12	12	11	11	11	10	10	9	EX6
		50	49	48	46	45	44	42	41	39	38	36	35	33	EX7
		152	148	144	140	136	132	128	124	119	115	110	105	101	EX8
+30	0.1	5	4	4	4	4	4	4	4	4	4	3	3	3	EX6
		16	16	15	15	15	14	14	13	13	13	12	12	11	EX7
		49	48	47	46	45	43	42	41	40	38	37	36	34	EX8
	0.5	10	10	10	9	9	9	9	8	8	8	8	7	7	EX6
		35	35	34	33	32	31	31	30	29	28	27	26	25	EX7
		108	105	103	101	98	95	93	90	87	84	81	78	76	EX8
	1.0	14	13	13	13	13	12	12	12	11	11	10	10	10	EX6
		49	48	47	46	45	43	42	41	40	38	37	36	34	EX7
		149	146	142	139	135	132	128	124	120	117	113	109	104	EX8

Application Hot Gas Flow such as Heat Reclaim Application

Condensing Temperature °C	Pressure Drop bar	R410A		Extended Capacity KW Evaporating Temperature (°C)											Valve type
		+15	+10	+5	0	-5	-10	-15	-20	-25	-30	-35	-40	-45	
+60	0.1	6	6	6	6	5	5	5	5	5	5	4	4	4	EX6
		21	21	20	20	19	19	18	18	17	16	16	15	15	EX7
		64	63	62	60	58	57	55	53	52	50	48	46	44	EX8
	0.5	13	13	13	12	12	12	11	11	11	10	10	10	9	EX6
		47	46	45	44	43	41	40	39	38	36	35	34	32	EX7
		143	140	137	133	130	126	122	118	115	111	107	103	99	EX8
	1.0	19	18	18	17	17	16	16	15	15	14	14	13	13	EX6
		66	64	63	61	60	58	56	55	53	51	49	47	46	EX7
		200	196	191	186	182	177	171	166	161	155	150	144	138	EX8
+50	0.1	6	6	6	6	6	6	5	5	5	5	5	5	4	EX6
		22	22	21	21	20	20	19	19	18	18	17	17	16	EX7
		67	66	65	63	62	60	59	57	55	54	52	50	48	EX8
	0.5	14	14	13	13	13	12	12	12	11	11	11	10	10	EX6
		49	48	47	46	45	44	43	42	40	39	38	37	35	EX7
		149	146	143	140	137	133	130	126	123	119	115	111	108	EX8
	1.0	19	19	19	18	18	17	17	16	16	15	15	14	14	EX6
		69	67	66	64	63	61	60	58	57	55	53	51	50	EX7
		209	204	200	196	191	186	182	177	172	167	161	156	151	EX8
+40	0.1	6	6	6	6	6	6	5	5	5	5	5	5	5	EX6
		22	22	21	21	20	20	19	19	18	18	17	17	16	EX7
		67	66	65	63	62	60	59	58	56	54	53	51	50	EX8
	0.5	14	13	13	13	13	12	12	12	11	11	11	11	10	EX6
		49	48	47	46	45	44	43	42	41	40	39	37	36	EX7
		148	146	143	140	137	134	131	127	124	121	117	114	110	EX8
	1.0	19	19	18	18	18	17	17	16	16	16	15	15	14	EX6
		68	67	66	64	63	61	60	59	57	55	54	52	51	EX7
		207	203	199	195	191	187	182	178	173	168	164	159	154	EX8
+30	0.1	6	6	6	6	6	5	5	5	5	5	5	5	5	EX6
		21	21	21	20	20	19	19	19	18	18	17	17	16	EX7
		65	64	63	61	60	59	58	56	55	53	52	51	49	EX8
	0.5	13	13	13	13	12	12	12	12	11	11	11	10	10	EX6
		47	46	45	45	44	43	42	41	40	39	38	37	36	EX7
		143	141	138	135	133	130	127	124	121	118	115	112	109	EX8
	1.0	18	18	18	17	17	17	16	16	16	15	15	14	14	EX6
		65	64	63	62	61	60	58	57	56	54	53	51	50	EX7
		199	195	192	188	185	181	177	173	169	165	160	156	152	EX8

Electrical Control Valves Series EX4, EX5, EX6, EX7, EX8

Technical Data

Compatibility *	HCFCs, HFCs, CO ₂ Mineral and POE lubricants
MOPD (maximum operating pressure differential)	EX4/EX5/EX6: 40 bar EX7: 35 bar EX8: 30 bar
Max. allowable pressure, PS	EX4/EX5/EX6/EX7: 60 bar EX8: 45 bar
Medium temperature range: Uniflow version Biflow version	Liquid inlet temperature TS: -50 ... +100°C TS: -40 ... +80°C
Evaporating temperature range:	-100°C to +40°C (uniflow version)
Ambient temperature Storage temperature	-40 ... +55°C -40 ... +70°C
CE marking EX4/EX5 EX6/EX7/EX8	not required required, Cat I, Module A
Salt spray test	non-corrosion stainless steel body
Humidity	5 ... 95% R.H.

* Valves are not released for use with inflammable refrigerants.

Connections	ODF stainless steel fittings
Protection accordance to IEC 529, DIN 40050	IP 67 with Alco supplied cable connector assembly
Vibration for non-connected and fastened valve	4 g (0 .. 1000 Hz, 1 Oktave /min.)
Shock	20g at 11 ms, 80g at 1 ms
Net weight	0.5 kg (EX4), 0.52 kg (EX5), 0.6 kg (EX6), 1.1 kg (EX7), 1.5 kg (EX8)
Full travel time	EX4/EX5/EX6: 1.5 sec EX7: 3.2 sec., EX8: 5.2 sec
Seat leakage	Positive shut-off better than solenoid valve
External leakage	≤ 3 g / Year
Package and delivery	Single pack, without electrical connector

Block Diagrams

Superheat Control with EC3-X33 optional display unit ECD-002

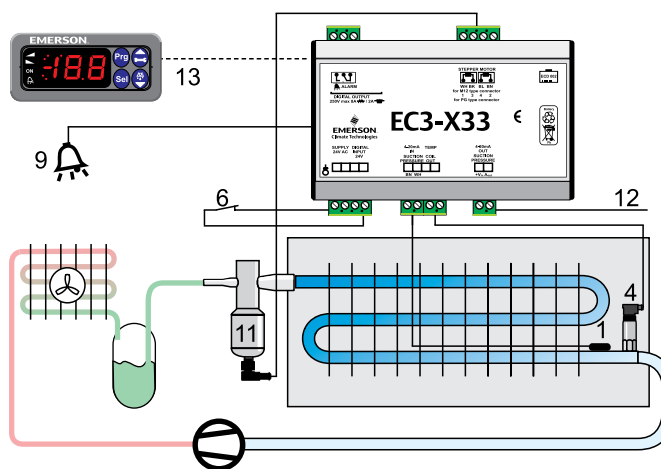

- 1 ECN-N60 sensor
- 4 PT5 pressure transmitter
- 6 Supply / Digital Input
- 9 Alarm out
- 11 EX4 ... EX8 valve
- 12 Suction pressure 4...20mA out
- 13 ECD-002 Display unit

Refrigerant Mass Flow Control with EXD-U

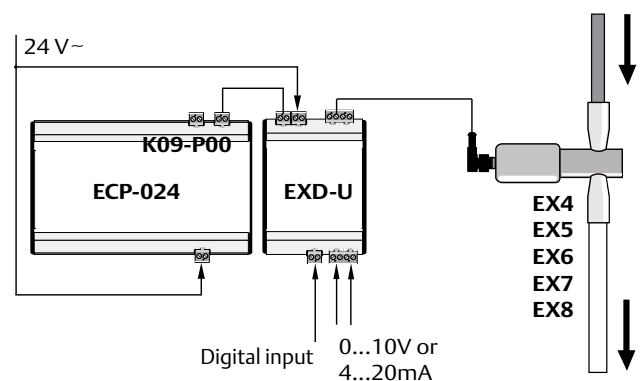

High Pressure Expansion Valves Series CX4, CX5, CX6, CX7

ALCO Controls CX4 / CX5 / CX6 / CX7 are stepper motor driven valves for precise control of refrigerant mass flow in air conditioning and refrigeration systems with CO₂. The Control Valves can be used as high pressure gas valve for gas cooler control, expansion device, hot gas and cold gas bypass, liquid injection duty, evaporator pressure regulator, crankcase pressure regulator, head pressure regulator, or liquid level control.

Features and Benefits

- Multifunction
- Fully hermetic design in two versions: ODF connections and thread connections
- Mainly for CO₂ systems
- Stepper motor driven
- Short opening and closing time
- Very fast full-stroke time
- High resolution and excellent repeatability
- Positive shut-off function to eliminate the use of an additional solenoid valve
- Linear flow capacity
- Extremely wide capacity range (10 ... 100%)
- Direct coupling of motor and valve for high reliability (no gearmechanism)
- Ceramic slide and port for accurate flow and minimal wear
- Balanced force design
- Corrosion resistant stainless steel body and connections
- Europe patent No. 0743476, USA patent No. 5735501, Japan patent No. 28225789



CX4/5/6/7 with ODF connections



CX4/5/6/7 with thread connections

Selection Table

Type	Part No.	Kv (m ³ /hr)	Capacity Range	Inlet Connection	Outlet Connection	Electric Connector
CX4-CO2	801 990	0.2	10 ... 100%	3/8" ODF	5/8" (16 mm) ODF	M12 plug
CX5-CO2	801 991	0.6		5/8" (16 mm) ODF	7/8" (22 mm)	
CX6-CO2	801 992	1.5		7/8" (22 mm) ODF	1-1/8" ODF	
CX7-CO2	801 996	5.5		1-1/8" ODF	1-1/8" ODF	
CX4-CO2F	802 000	0.2		5/8" Thread	5/8" Thread	
CX5-CO2F	802 001	0.6		7/8" Thread	7/8" Thread	
CX6-CO2F	802 002	1.5		7/8" Thread	7/8" Thread	
CX7-CO2F	802 003	5.5		7/8" Thread	7/8" Thread	

Note 1: The valves are delivered without cable/connector assembly (order separately).

Note 2: The valves with thread connections are delivered without counterpart steel tube fitting

Cable and Connector Assemblies

Type	Part No.	Temperature Range	Length	Connector type to valve	Connector type to driver board or controller	Illustration
EXV-M15	804 663	-50 ... +80°C	1.5 m	M12	Loose wires	
EXV-M30	804 664		3.0 m			
EXV-M60	804 665		6.0 m			

Accessory Kit

Kit set	Part No.	Kit content	Useable for valve type	External tube (outside diameter)	Required quantity of kits for each valve (inlet and outlet)	Illustration
CXK-058	802 010	Two ferrule grips and one nut	CX4-CO2F	5/8"	2	
CXK-078	802 011		CX5-CO2F	7/8"	2	
			CX6-CO2F	7/8"	2	
			CX7-CO2F	7/8"	2	

Electronic Controllers and Sensors

Selection Table Electronic Controllers

Description	Network Communication		
	Without	TCP/IP	LON

Superheat Controllers And Stepper Motor Drivers

Superheat controller for electrical control valves EX4 ... EX8	EC3-X33	EC3-X32	
Digital superheat controller for electrical control valves EX4 ... EX6	EC3-D73	EC3-D72	
Universal stepper driver module for electrical control valves EX4 ... EX8	EXD-U01		

Display Case And Cold Room Controllers For Electrical Control Valve

Temperature + superheat control of EX2 (pressure/temperature input)		EC2-352	
version for use with a compressor pack system		EC2-372	
Temperature + superheat control of EX2 (temperature/temperature input)		EC2-312	
version for use with a compressor pack system		EC2-392	
Temperature + superheat control of EX4 ... EX8 (stepper motor)		EC3-332	EC3-331

Condensing Unit Controllers

For 1 Copeland Scroll Digital™ and 1 single stage or 2 single stage compressors, fan speed control		EC2-552	
--	--	---------	--

Pressure Transmitter

Output signal 4 ... 20mA	PT5		
--------------------------	-----	--	--

Temperature Sensors

NTC	ECN-...		
-----	---------	--	--

Drivers for DIGITAL-Copeland Compressors

Driver for Digital Scroll compressors and 3-cylinder digital semi hermetic compressors	EC3-D13		
Driver for 4- and 6-cylinder digital semi hermetic compressors	EC3-D23		

Compressor Soft Starter

For single phase compressor motors with up to 32A	CSS		
---	-----	--	--

Electronic Fan Speed Controllers

Pressure actuated, current range 0.1 ... 4A	FSY		
Fan Speed Control Modules for EC-type motors	FSE		

Electronic Superheat Controllers and Stepper Motor Drivers

Emerson Climate Technologies designs superheat controllers and valve drivers for stepper motor driven control valves for all commercial refrigeration and air conditioning applications.

The **EC3-X33** is a universal superheat controller without network communication for air conditioning, refrigeration and industrial applications such as chillers, industrial process cooling, rooftops, heat pumps, package unit, close control, cold room, food process and air driers. The ECD-002 Display/Keypad Unit is necessary for setup but not for operation of the controllers. ECD-002 can be connected or disconnected to the EC3-X33 at any time.

In the event of a cooling request and compressor start-up, the EC3-X33 needs to be informed. This can be achieved by a digital input. The EC3-X33 will start to control the refrigerant mass flow stand-alone by precise positioning of the Control Valve under different operating conditions such as compressor start-up, start of a further compressor, high head pressure, low head pressure, high load, low load and partial load operation. EC3-X33 is capable for diagnostics and alarm. The alarm can be received via relay output as well as optical LED/alarm code on ECD-002.

The **EC3-X32** has the same function as EC3-X33 but with a TCP/IP Ethernet communication interface enabling the controller to be directly connected to a network or a PC via the standard Ethernet port. The EC3-X32 controller has embedded WebPages to enable the user to visualise the parameter list with a standard WebBrowser

Display Case and Coldroom Controllers

The compact **EC2** series is available with TCP/IP communication protocol and also covers applications where the display cases are connected to a multiple compressor application. In this case, the dedicated compressor relay on the controller is no longer required and is available as a spare relay to perhaps switch the display case lighting.

The controllers therefore can be split into two groups; controller is required to switch the compressor directly; integral application and those connected to a multiple compressor (rack) system.

The **EC2-31x** and **EC2-35x** have the dedicated compressor relay.

The **EC2-39x** and **EC2-37x** are for use with the rack system.

The controllers are specifically designed for display cases for use **with EXVs** and perform the function of thermostat, defrost and fan management and are capable of operating a standalone condensing unit or being incorporated into a distributed system controlled by a rack.

All display case and cold room controllers feature many useful functions like temperature control, defrost and fan management, as well as alarm functions. An additional control circuit takes care for stable superheat control with EX2 type Pulse Width Modulated Expansion valves (EC2-3xx) and with EX4 ... EX8 Stepper Motor driven Electrical Control valves (EC3-3).

EC2-31x / EC2-39x (Temp / Temp): the superheat is controlled using two temperature sensors.

EC2-35x / EC2-37x (Pressure / Temp): the superheat is controlled using a pressure transmitter (PT5 series) in conjunction with a temperature sensor.

like Internet Explorer®. When suitably connected, the controller is able to automatically send alarms by email to a PC or mobile phone.

For use with **Copeland Scroll Digital™** technology two other models are available. **EC3-D73** is a stand-alone version for use with the ECD-002 Display / Keypad unit whilst the **EC3-D72** has a TCP/IP Ethernet interface. A 0-10V demand signal is required from a third party controller to control a tandem system with one fixed and one digital compressor. A patented algorithm synchronises the operation of the PWM digital compressor valve and the EX series electrical control valve.

EXD-U Universal Drivers are stepper motor drivers and enable the operation of Alco stepper motor driven valves EX4 ... EX8 as electronic expansion valve, capacity control by means of hot gas bypass or evaporating pressure regulator, crankcase pressure regulator, condenser pressure regulator, liquid level and liquid injection.

The EXD-U universal driver can be connected to any controller which can provide a 4-20mA or 0-10V analogue signal. The output is the opening/closing of EX4 ... EX8 and consequently the control of the refrigerant liquid or vapor mass flow in accordance with the analogue input.

Whilst the products were developed for display cases, they may also be applied to control a simple coldroom.

In principle, the **EC3 series** utilize the same software technology of the EC2 series but provide additional inputs and outputs to satisfy the requirements of even the most demanding systems. Like the EC2, the EC3 series may be connected together to form larger systems combining the control of multiple compressors and fans.

The optional **ECD-001 Display/Keypad Unit** is available to display the system temperatures, indicate system status and to modify parameters.

The **EC3-3XX** series are specifically for use with stepper valve series (EX4, EX5, EX6, EX7, EX8). In case of power loss, the Electrical Control Valve needs to be closed to avoid flooding of the compressor, therefore each valve requires a battery backup. For this reason, the battery, together with its automatic charging circuit, has been incorporated into the controller housing, significantly saving installation time as well as space in the electrical enclosure.

Condensing Unit Controllers

Condensing Unit Controllers

The **EC2-5xx** series of controllers are suitable for controlling the compressors and fans of a condensing unit. Digital inputs are available for individual compressor feedback loops from the safety chain, which typically consists of low and high pressure switches together with motor protection and oil management controls. A common feedback is also available for the fans.

Following models are available:

EC2-512: to control up to 2 compressors (on/off control) and 2 fans (on/off control).

EC2-552: to control up to 2 single stage compressors or tandem compressor condensing units with a **Copeland Scroll Digital™** compressor. It features a 0...10V output to control fan motor speed with an inverter or to connect to ECM type fan motors directly.

PT5 series pressure transmitters are used to measure the suction and discharge pressures to modulate the compressor and fan capacities.

Network Communication and System Management

The Alco EC Series of drivers and controllers utilise the very latest in communication technology which sets new standards in the refrigeration industry. Energy saving algorithms are incorporated into many of the controllers, including adaptive superheat and thermostat modulation, defrost on demand & suction and discharge setpoint shift.

EC2 or **EC3** controllers are available with TCP/IP Ethernet communication protocol. EC3-331 is also available with LON protocol.

TCP/IP Ethernet:

The controllers are Ethernet based enabling them to be connected directly to any computer via the Ethernet port (RJ45 connector). The controllers act as web server enabling the engineer to pick up standard configuration pages directly from the controllers without the need of any additional hardware or software. The most convenient way to connect a controller to the PC is to use a router that will automatically assign a TCP/IP address. The engineer can access the monitoring and parameter configuration pages by entering the TCP/IP number into the address line of an Internet browser such as Mozilla or Microsoft Internet Explorer. User name and password protection is provided to protect the controller from unauthorized access.



The **TCP/IP based Controllers** offer a practical solution, particularly for smaller installations that require communication for monitoring purposes without the need for customized visualization. For many installations, an additional monitoring server is not required.

Other Functions:

- Monitoring of system temperatures and pressures as well as relay status information
- Read/write of EC2 & EC3 control parameters
- Real-time graphical visualization
- Log function of up to one month's data directly on the controller
- Log function of data to a PC *
- Storage and retrieval of system parameter

* Controller must be connected to the PC

Superheat Controllers Series EC3-X32 / EC3-X33

For stable superheat control with stepper motor driven electrical control valves Series EX4 - EX8

Digital Superheat Controllers Series EC3-D72 / EC3-D73

For stable superheat control with EX4...EX6 electrical control valves and automatic synchronisation of the PWM capacity control valve incorporated into the Copeland Scroll Digital™ compressor technology

Features

- Limitation of evaporating pressure (MOP)
- Feed-through of 4 ... 20mA signal of evaporating pressure transmitter to operate third party controllers with a common pressure transmitter
- Intelligent alarm management, superheat alarm
- Monitoring of sensors and sensor wiring, detection of sensor and wiring failures
- Integral rechargeable battery to close Electrical Control Valve in case of power loss
- Electrical connection via plug-in type screw terminals
- Aluminum housing for DIN rail mounting

Additional features EC3-X32 and EC3-D72 with TCP/IP

- WebServer functionality allows monitoring and configuration of controllers through a standard Web browser (e.g. Internet Explorer®)
- Internal data logging
- Multiple language support (www.emersonclimate.eu)



EC3-X33 with ECD-002

- Freeze protection
- Low and high superheat alarm
- Low pressure switch function/alarm

ECD-002 Display Unit

- Front panel mounted interface for parameter and status read-out and controller setup via keypad
- Indicator LEDs for valve opening/closing, external ON and alarm

Selection Chart

Description	TCP/IP			Stand alone		
	Type	Part No. single unit	Part No. Kit*	Type	Part No. single unit	Part No. Kit*
Superheat Controller	EC3-X32	807 782	808 037	EC3-X33	807 783	808 036
Terminal Kit for EC3-X32/-X33	K03-X32	807 644		K03-X33	807 645	
Digital Superheat Controller	EC3-D72	807 805	808 042	EC3-D73	807 804	808 041
Terminal Kit for EC3-D72/-D73	K03-331	807 648		K03-331	807 648	

* Kits contain terminal kit, pressure transmitter PT5-07M with cable assembly, NTC sensor 6m, transformer 60VA (see chapter 'Accessories & Spare Parts')

Accessories

Description	Type	Part No.	Note
Display	ECD-002	807 657	
Connection cable EC3 to ECD	ECC-N10	807 860	1m cable length
	ECC-N30	807 861	3m cable length
	ECC-N50	807 862	5m cable length
Pressure Transmitter	PT5-07M	802 350	for R134a, R22, R404A, R407C, R507C, R124
	PT5-18M	802 351	for R410A only
	PT5-30M	802 352	for R744
Cable Assembly for PT5	PT4-M60	804 805	other cable lengths see Pressure Transmitter Series PT5
Temperature Sensor NTC	ECN-N30	804 496	3m cable length
	ECN-N60	804 497	6m cable length
	ECN-N99	804 499	12m cable length
Transformer 25VA 230V/24V AC 60VA	ECT-323	804 424	for EX4 to EX7
	ECT-623	804 421	for EX8, DIN rail mounting

Typical Ordering Package

System with 100 kW cooling capacity and refrigerant R22 requires the following parts:

EX6	Electronic Expansion Valve	ECN-N60	NTC Temperature Sensor
EXV-M60	Electrical Cable and Plug assembly	PT5-07M	Pressure Transmitter
EC3-X33	Superheat Controller Stand-alone	PT4-M60	Cable assembly PT5 6.0m
K03-X33	Terminal Kit for EC3-X33	ECD-002	Display (optional)
ECT-323	Transformer 25VA	ECC-N30	Connection cable EC3 to ECD (opt.)



PT5

PT4-Mxx

ECT-323

Universal Driver Modules Series EXD-U01

Stepper motor valve driver specifically designed for the Emerson EX and CX Series of electrical control valves in applications such as:

- Capacity control by means of hot gas bypass
- Evaporating pressure regulator or crankcase pressure regulator
- Hot gas flow such as heat reclaim
- Condensing pressure regulation and liquid duty
- Refrigerant mass flow control in CO₂ transcritical systems

Features

- Plug and play, no parameter setting
- Valve opening proportional to 4-20mA or 0-10V analogue input signal
- Digital input can be used to force valve closing
- Dip-switches for selection of Electrical Control Valves, analog input
- Aluminum housing for DIN rail mounting
- Easy wiring
- Fully tested and ready for operation
- CE-marking for electromagnetic compatibility
-

Options

- Uninterruptible Power Supply ECP-024 to automatically close valve after power down



EXD-U01

Selection Chart

Description	Type	Part No. single unit
Universal Driver Module	EXD-U01	804 750
Electrical Terminal Kit	K09-U00	804 559

* Controller Kit contains terminal kit

Accessories

Description	Type	Part No.	Note
Uninterruptible Power Supply	ECP-024	804 558	for up to 2 driver modules
Electrical Terminal Kit	K09-P00	804 560	for ECP-024
Transformer	25VA	ECT-323	
230V/24V AC	60VA	ECT-623	DIN-rail mounting

Capacity Data

See “Electrical Control Valves EX4...EX8” data.

See Technical Bulletin “EXD-U01_TB” for detailed data and its application in CO₂ systems.



ECP-024



ECT-323

Display Case and Universal Controllers Series EC2

With Web Server functionality and TCP/IP Protocol

Features of all models:

- Superheat control for Pulse Width Modulated Valves (e.g. EX2-Series) see Selection Table
- Self-adapting controller, no user setup necessary
- Limitation of evaporating temperature (MOP)
- Air temperature control
- Defrost timer for natural, electric or hot-gas defrost with fan control
- Integrated timer and alarm functions
- All parameters and functions are programmable:
 - via standard Web browser (EC2-xx2 models)
 - with integral keypad
- Password protection to eliminate unauthorized use
- Multiple language support (www.emersonclimate.eu)
- Standard 29 x 71 mm cutout dimensions
- 2 ½ digit display in °C or °F
- CE marking



EC2 Controller

Communication TCP/IP Ethernet

- Web Server function provides monitoring and configuration through a standard web browser. Ethernet interface, as used in most office PCs
- Graphical visualisation via built-in Web pages
- Fixed or dynamic TCP/IP address with username and password
- Up to 30 days datalog





Example for Web page monitoring



Selection Table

Functional Overview	TCP/IP		
	Type	Part No. single unit	Part No. Kit*
Display Case and Cold Room Controllers			
Temperature and Superheat Control of EX2 (Press. / Temp. input) Version for use with a compressor pack system	EC2-352 EC2-372	807 772 807 688	808 009 808 011
* Kit contains terminal kit, pressure transmitter PT5-07M with cable assembly, transformer 25VA, 4 NTC sensors 6m fin, pipe and air version (EC2-35x only)			
Temperature and Superheat Control of EX2 (Temp. / Temp. input) Version for use with a compressor pack system	EC2-312 EC2-392	807 682 807 692	808 005 808 007
* Kit contains terminal kit, transformer 25VA, 5 NTC sensors 6m fin, pipe and air version (EC2-31x only), see chapter "Accessories & Spare Parts".			

Accessories

		Type	Part No.	
Terminal kits, cables				 <p>K02-000</p>  <p>ECN-XX</p>  <p>PT5 PT4-Mxx</p>  <p>ECT-323</p>
Terminal kit for EC2-31x, -35x, -37x, -39x		K02-000	800 050	
Ethernet Cable RJ45/4-pin-conn.	6m cable length	ECX-N60	804 422	
Sensors				
Air-Sensors, single insulated (10 kΩ at 25°C) for EC2-21x, -31x, -35x	1.5m cable length	ECN-S15	804 304	
	3m cable length	ECN-S30	804 305	
	6m cable length	ECN-S60	804 284	
Pipe and pocket sensors NTC (10 kΩ at 25°C) Air sensors for EC2-29x, EC2-3xx	3m cable length	ECN-N30	804 496	
	6m cable length	ECN-N60	804 497	
	12m cable length	ECN-N99	804 499	
Defrost sensor (10 kΩ at 25°C) (including fin clip)	6m cable length	ECN-F60	804 283	
Pressure transmitter	-0.8...7 bar	PT5-07M	802 350	
	0 ... 18 bar	PT5-18M	802 351	
Cable plug assembly for PT5	1.5m cable length	PT4-M15	804 803	
	3m cable length	PT4-M30	804 804	
	6m cable length	PT4-M60	804 805	
Transformer				
230VAC Input, 24V output	25VA	ECT-323	804 424	

Technical Data

Supply voltage	24V AC ±10% 50/60 Hz class II only
Power consumption	20VA incl. EX2 valve (EC2-3xx)
Inputs	up to 5 Temperature sensors: Refrigerant inlet (saturated temp.) Refrigerant outlet (suction temp.) Air into / Air out of evaporator Defrost termination
Output contact rating	SPDT & SPST relays, 250V max / 8A resistive load EC2-3xx
cos φ = 0.5: (Voltage free contacts)	2A inductive load all EC2 (defrost, compressor, fan)
Triac output to EX2	24VAC, 1 A max.
Communication	TCP/IP: Ethernet

Temperature storage	-10 ... +70°C
operation	0 ... +50°C (housing)
operation	- 50 ... +50°C (NTC sensor)
Display	2 1/2 digits red LED Automatic decimal point between -19.9 & +19.9 Switchable between °C & °F
Indicator LEDs	Compressor, defrost, fan, alarm,
Varies upon model	service LED
Protection (EN 60529)	IP 65 (front protection with gasket)
Sensor type	NTC 10KΩ @ 25°C Order codes see above
Weight	~ 150g

Typical Order Package for a display case

Case Controller	EC2-312	807 682
Terminal Kit	K02-000	800 050
Electrical Control Valve	EX2-M00	801 091
Orifice size 3	EXO-003	801 088
Coil 24VAC / 10W	ASC3 24V	801 079
Cable Assembly for ASC3	ASC-N15	804 570
2 pipe sensors	ECN-N60	804 497
2 air sensors	ECN-S30	804 305
Defrost sensor	ECN-F60	804 283
Transformer 25VA	ECT-323	804 424
Ethernet Cable 6m	ECX-N60	804 422

Block Diagrams

EC2-35x / -37x Case Controller (EX2, Press/Temp)

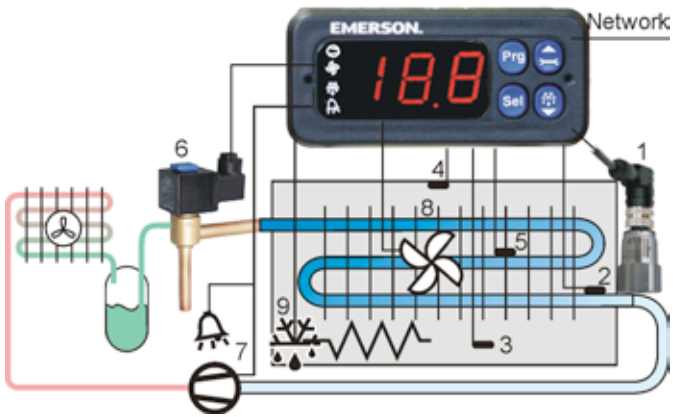

Inputs

- 1 = Suction pressure
- 2 = Coil out temperature
- 3 = Air in temperature
- 4 = Air out temperature
- 5 = Defrost temperature

Outputs

- 6 = EX2 Expansion valve
- 7 = Compressor (EC2-35x only)
Spare relay (EC2-37x only)
- 8 = Fan
- 9 = Defrost heater

EC2-31x / -39x Case Controller (EX2, Temp/Temp)

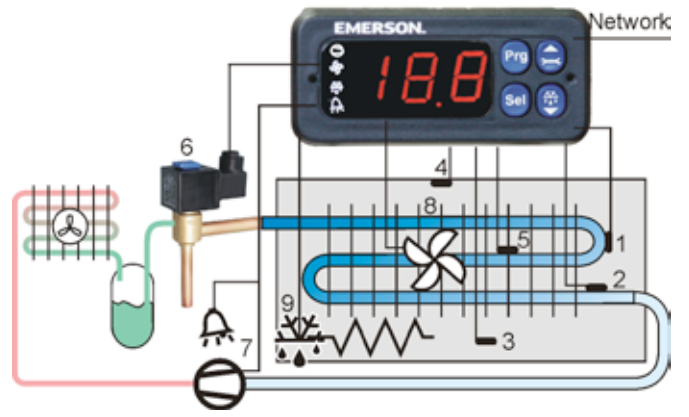

Inputs

- 1 = Coil in temperature
- 2 = Coil out temperature
- 3 = Air in temperature
- 4 = Air out temperature
- 5 = Defrost temperature

Outputs

- 6 = EX2 Expansion valve
- 7 = Compressor (EC2-31x only)
Spare relay (EC2-39x only)
- 8 = Fan
- 9 = Defrost heater

Condensing Unit Controllers Series EC2

With Web Server Function and TCP/IP Interface

Common Features

- Maintenance and alarm management
- Sensor failure handling
- Inputs for common low and common high pressure alarms
- Configuration data stored in non-volatile memory
- Electrical connection via plug-in type screw terminals
- with Web Server Function and TCP/IP Interface (see beginning of this chapter)
- Operation and commissioning via local or remote PC
- CE marking



EC2 Controller

Condensing Unit Controllers

- To control a combination of compressors and condenser fans based on suction and condensing pressure respectively
- Control of Copeland Scroll Digital™ Compressors

Communication TCP/IP Ethernet

- Web Server Function provides monitoring and configuration through a standard Web browser. Ethernet interface, as used in most office PCs
- Graphical visualization via built-in Web pages
- Fixed or dynamic TCP/IP address with username and password
- Up to 30 days datalog
- Multiple language support (see www.emersonclimate.eu)

Selection Table

Description	TCP/IP		
	Type	Part No. single unit	Part No. Kit*

Condensing Unit Controllers

Condensing Unit Controller for 2 compressors or 1 Digital Scroll and 1 single stage compressor, variable fan speed control	EC2-552	807 738	808 019
--	---------	----------------	----------------

* EC2-5xx Kits contains terminal kit, pressure transmitters PT5-07M and PT5-30M with cable assemblies, transformer 25VA (see "Pressure Transmitters Series PT5").

Accessories

Description	Type	Part No.
Terminal kits for EC2-55x series	K02-540	800 070

NTC Sensor ECN single insulated for ambient temperature sensing -50 ... +50°C (10kΩ at 25°C)	1.5m	ECN-S15	804 304
	3m	ECN-S30	804 305
	6m	ECN-S60	804 284

Pressure transmitter PT5 for suction and condensing pressure sensing (details "Pressure Transmitters Series PT5")			
-0.8 ... 7 bar, 4 ... 20mA		PT5-07M	802 350
0 ... 18 bar, 4 ... 20mA		PT5-18M	802 351
0 ... 30 bar, 4 ... 20mA		PT5-30M	802 352
Cable assembly	1.5m	PT4-M15	804 803
	3.0m	PT4-M30	804 804
	6.0m	PT4-M60	804 805

Transformer 230VAC Input, 24V output	25VA	ECT-323	804 424
--------------------------------------	------	---------	----------------



K02-211



PT5 PT4-Mxx



ECT-323

Block Diagrams

EC2-552 Condensing Unit Controller for 2 single stage compressors or 1 Digital Scroll and 1 single stage compressor

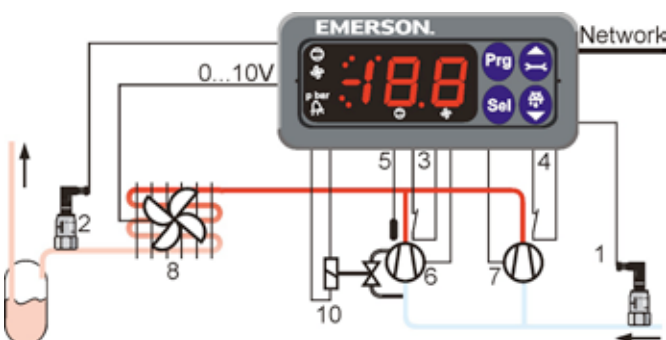

Inputs

- 1 = Suction pressure
- 2 = Condenser pressure
- 3 = Safety switch comp 1
- 4 = Safety switch comp 2
- 5 = Temperature input

Outputs

- 6 = Digital Scroll Compressor
- 7 = Single Stage Compressor
- 8 = Speed controlled fan with EC-motor
- 10 = PWM Digital Scroll Solenoid valve

Coldroom Controller Series EC3

Temperature and Superheat Control of EX4 ...EX8 (Stepper Motor)

Features

- Superheat control with self-adapting algorithm for Stepper Motor driven ECVs (EX4 ... EX8)
- Thermostat, fan & defrost control
- Limitation of evaporating temperature (MOP)
- Analog inputs: 3 NTC temperature sensors
- With integral backup battery to close Control Valve in case of power loss
- Analog input for suction pressure measurement using Alco PT5 Series pressure transmitters
- Digital inputs for compressor safety and coldroom door contact
- Relay outputs for compressor, defrost and alarm plus programmable relay
- All parameters and functions are programmable:
 - via TCP/IP Ethernet controller (EC3-332)
 - with keypad of optional display unit ECD-001
- Electrical connections via plug-in type screw terminals
- Lightweight aluminum enclosure for DIN rail mounting
- Multiple language support (see www.emersonclimate.eu)
- CE marking

Communication TCP/IP Ethernet

- Web Server Function provides monitoring and configuration through a standard Web browser. Ethernet interface, as used in most office PCs
- Graphical visualization via built-in Web pages
- Fixed or dynamic TCP/IP address with username and password
- Up to 30 days datalog
- Multiple language support (see www.emersonclimate.eu)



EC3-332

ECD-001

Features of ECD-001 Display Unit

- For various system temperatures and valve opening readout
- Connection to EC3 Series via a RJ45 Western Digital plug. No further power cables required
- 2 ½ digit display
- Indicator LEDs for compressor, fan, heater and alarm
- 4 keys allow parameter modification
- Easy mounting in panels with 71 x 29 mm cutout
- IP65 if mounted in front panel

Typical Order Package

Coldroom Controller	EC3-332	807 632
Terminal Kit	K03-331	807 648
Display Unit (optional)	ECD-001	807 641
Connection cable EC3 to ECD 1m	ECC-N10	807 860
Transformer 25VA	ECT-323	804 424
<i>Sensors: depending on application</i>		
Ethernet Cable 5m	ECC-N50	807 862

Selection table

Description	TCP/IP		
	Type	Part No. single unit	Part No. Kit*
Coldroom Controller ECV Stepper Motor Drive	EC3-332	807 632	808 013

*Kit contains terminal kit, pressure transmitter PT5-07M with cable assembly, transformer 25VA, NTC sensors 6m fin, pipe and single insulated version (see chapter "Accessories & Spare Parts")

Accessories

Terminal Kits			
Description	Type	Part No.	
Terminal kit for EC3-33x	K03-331	807 648	
ECD Series Display Units			
Display for EC3-33x	ECD-001	807 641	
Connection cable EC3 to ECD	1m cable length	ECC-N10	807 860
	3m cable length	ECC-N30	807 861
	5m cable length	ECC-N50	807 862
NTC Sensors (Air type) (10 kΩ at 25°C)	1.5m cable length	ECN-S15	804 304
	3m cable length	ECN-S30	804 305
	6m cable length	ECN-S60	804 284
Pipe and pocket sensors NTC (10 kΩ at 25°C)	3m cable length	ECN-N30	804 496
	6m cable length	ECN-N60	804 497
	12m cable length	ECN-N99	804 499
NTC Sensors (Fin type) (10 kΩ at 25°C)	6m cable length	ECN-F60	804 283
Pressure transmitter	-0.8...7 bar	PT5-07M	802 350
Cable plug assembly	1.5m length	PT4-M15	804 803
Transformer, Class II	230VAC Input / 24V output	25VA	ECT-323 804 424
		60VA	ECT-623* 804 421

* EX8 only



K03-331



PT5 PT4-Mxx



ECT-623



ECN-XX

Technical Data

Controller EC3-33x

Supply voltage	24 VAC ±10%, 50/60 Hz Class II
Power consumption	25VA max. for EX4 .. EX7 28VA max. for EX8
Plug-in connector size	Removable screw version wire size 0.14 ... 1.5 mm ²
Communication interface	TCP/IP Ethernet with Webserver (EC3-332)
Temperature storage operating	-20 ... +65°C 0 ... +60°C
Humidity	0 ... 80% r.h. non condensing
Protection class	IP 20 (EN 60529)
Weight	~ 800 g
Mounting	DIN rail mounted

Display Unit ECD-001

Supply voltage	via ECC-N10 from EC3 controller
LED indicators	Compressor, fan, defrost, alarm outputs LON service pin
Display LED	Numeric segmental display, red, 2 1/2 digits with automatic dec. point betw. ±19.9; switchable between °C and °F
Operating Keys	4 operating keys: Programming, select service/up, defrost/down
Temperature storage operating	-20 ... +65°C 0 ... +60°C
Humidity	0 ... 80% r.h. non condensing
Protection class	IP 65 (front panel with gasket)
Weight	~ 52 g
Mounting	Panel door (71 x 29mm cutout)

Block Diagram

EC3-33x Coldroom Controller for stepper motor driven ECV

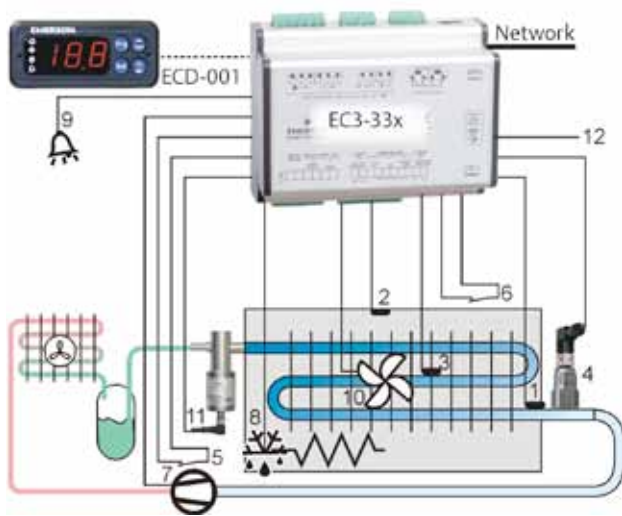

Inputs

- 1 = Coil out temperature
- 2 = Air temperature
- 3 = Defrost temperature
- 4 = Suction pressure
- 5 = Compressor safety
- 6 = Door contact

Outputs

- 7 = Compressor
- 8 = Defrost heater
- 9 = Alarm
- 10 = Fan
- 11 = Stepper motor ECV
- 12 = Output signal (4...20 mA)

Drivers for DIGITAL Copeland™ Compressors EC3-D13/EC3-D23

EC3-D13 driver for digital scroll compressors and 3 cylinder digital semi-hermetic compressors

EC3-D23 driver for 4 and 6 cylinder Stream digital semi-hermetic compressors

EC3-D13 /EC3-D23 drivers receive an input signal from an existing system controller (0...10V, 1...6V or 4...20mA) and activate digital solenoid valves for stepless capacity control of the digital scroll and digital semi-hermetic compressors .

For digital scroll compressors, an input allows monitoring of the discharge temperature or the compressor's DLT signal and to activate an alarm signal if the specified temperature is exceeded.

Features

- Valve opening PWM signal proportional to the analogue input signal
- Fully tested and ready for operation
- CE-marking for electromagnetic compatibility
- Electrical connections via plug-in type screw terminals



EC3-D13 with ECD-002

ECD-002 Display and key pad unit

- Display and interface for parameter setup and status read out
- For front panel mounting

Selection Chart Kits*

Description	Type	Copeland Part Number
Driver kit for digital scroll compressors	EC3-D13 kit	8405187
Driver kit for 4 and 6 cylinder Stream digital semi-hermetic compressors	EC3-D23 kit	3187293

Kit contain EC3-D13/D23, ECD-002 keypad/Display unit, terminal kit K03-331, connection cable EC3 to ECD 13/23, Transformer ECT-323 (230V AC input / 24 VAC, 25VA)

Selection Chart Individual Components

Description	Type	Copeland Part Number
Driver for digital scroll compressors	EC3-D13	8404935
Driver for digital scroll compressors with terminal kit	EC3-D13 & K03-331	3187306
Driver for 4 and 6 cylinder Stream digital semi-hermetic compressors	EC3-D23	3187282
Driver for 4 and 6 cylinder Stream digital semi-hermetic compressors with terminal kit	EC3-D23 & K03-331	3187317
Display and key pad unit	ECD-002	8403318
Terminal kit for Driver	K03-331	8405165
Connection cable EC3-D13/23 to ECD-002, 1m	ECC-N10	8557782
Transformer 230V AC input / 24 VAC, 25VA, DIN mount	ECT-323	8405176

Technical Data

Power supply	24VAC \pm 10%; 50/60Hz; 1A
Power consumption	5VA max.
Plug-in connector	Removable screw terminals wire size 0.14 ... 1.5 mm ²
Grounding	6.3 mm spade earth connector
Protection class (EN 60529)	IP20
Connection to ECD-002	ECC-Nxx or CAT5 cable with RJ45 connectors
Digital Input	I: 0/24VAC/DC for stop/start function
Analog Inputs	O: 4...20mA, 0...10V, 1...6V N: Copeland NTC temperature sensor (86K at 25°C) or Discharge Line Thermostat (DLT)
Digital Outputs (2):	H: Alarm L: Compressor relay for compressor contactor SPDT; I _{max} = 8A res (2A), V _{ACmax} = 250V Activated: During normal operation (no alarm condition) Deactivated: During alarm condition or power supply is OFF
Digital Scroll valve output	SPST contact, Solid State Relay (SSR) I _{max} = 1A res (1A), V _{ACmax} = 250V
Ambient temperature range	0 ... 50°C

Wiring

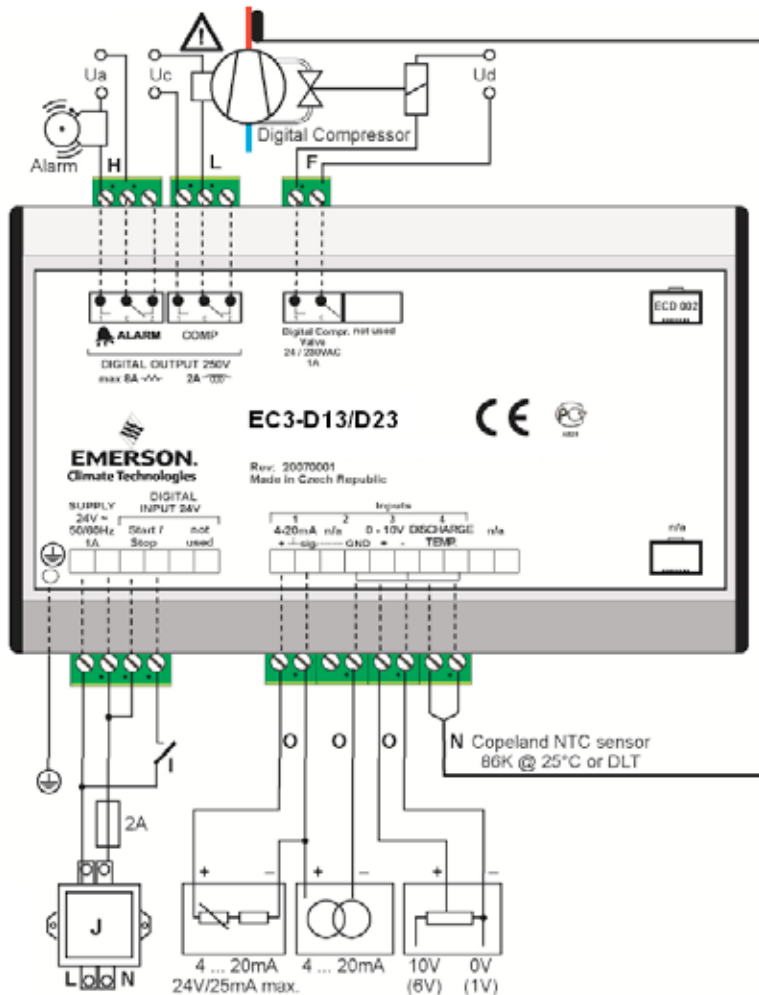

EXD-HP1/2 Stand-alone Superheat/Economizer Controller

EXD-HP1/2 are stand-alone universal superheat and or economizer controllers for heat pumps, heating units, air conditioning and precision cooling such as telecom and shelter applications.

Features EXD-HP1/2

- Self adapting superheat/economizer control in conjunction with EMERSON stepper motor driven electronic expansion Valves EXM/EXL
- Discharge hot gas temperature control by liquid/vapor injection to compressor
- EXD-HP1: Controller with one EXV output
- EXD-HP2: Controller with two independent EXV outputs
- Controllers as slave with Modbus (RTU) communication capability. All data (read/write) accessible by any third party controller having modbus communication (RTU)
- Upload/download key (accessory) for transmission of parameter settings among controllers with the same setting
- Low pressure switch and freeze protection function
- Manual positioning of valve(s)
- Limitation of evaporating pressure (MOP)
- Low/high superheat alarm
- Monitoring of sensors and sensor wiring / detection of sensor and wiring failures
- Integrated display (3-digit LEDs) and keyboard
- Electrical connection via plug-in type screw terminals (included with controller)
- DIN rail mounting housing
- **OEM product: Box/order quantities: 20 pieces (Multi-pack)**



EXD-HP2

Selection Chart

Description	Type	Part No.	
		M = Multipack (20 pieces)	Singlepack
Controller with one EXV output	EXD-HP1	807 836M	-
Controller with two EXV outputs	EXD-HP2	807 837M	-
Temperature sensor with 3 meter cable	ECP-P30	-	804 495
Electronic expansion valves	Valve: EXM-B0B	800 400M	-
	Valve: EXM-B0D	800 401M	-
	Valve: EXM-B0E	800 402M	-
	Coil: EXM-125	800 403M	-
	Valve: EXL-B1F	800 405M	-
	Valve: EXL-B1G	800 406M	-
	Coil: EXL-125	800 407M	-
Pressure sensors (Suction pressure) see chapter Pressure Transmitters -0.8...7 bar (R22, R134a, R407C) 0.....18 bar (R410A, R32)	PT5-07M	802 350M	802 350
	PT5-18M	802 351M	802 351
	PT6-18M	802 361M	802 361
Recommended for intermediate pressure (economizer control)	PT5-30M	802 352M	802 352
Plug and cable assembly for pressure sensor 1.5m cable length 3.0m cable length	PT4-M15	804 803M	804 803
	PT4-M30	804 804M	804 804
Transformer 25VA	ECT-323	-	804 424

Remark: For further details of EXM/EXL and PT5/PT6: Please see separate datasheet.

Simplified Illustration: Heating Scroll With Economizer

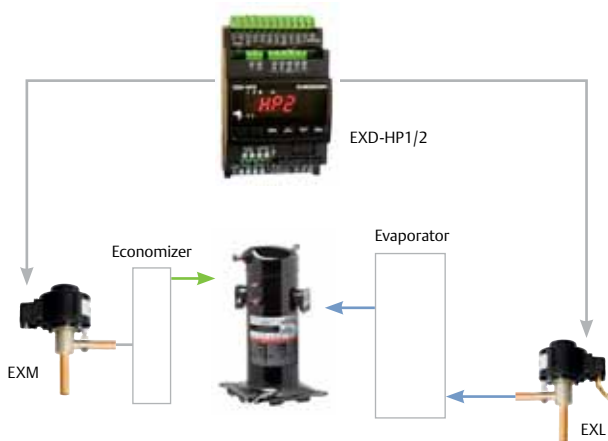

Alarm Functions

EXD-HP1/2 provides several alarms to facilitate diagnosis as well as shut down of compressor/system if the alarm relay is wired into the serial safety loop.

Alarm Relay Function

Alarm relay contains a SPDT contact. If the relay is wired to the system controller, it is possible to stop the compressor/system. The alarm relay is activated/energized during normal operation and deactivated/deenergized during alarm conditions as well as supply power interruption.

List of Alarms

Condition	Delay Time	Alarm Relay	Valve Position	Reset Type	Display Alarm LED
Hardware errors (sensors)	-	Triggered	Fully close	Auto	ON
Hardware errors (Stepper motor)	-	Triggered	-	Auto	ON
Low superheat	Fix: 1 min.	Triggered	Fully close	Auto/Manual	ON/Blinking
Discharge hot gas above limit	Fix: 1 min.	Triggered	Operating	Auto	ON
High superheat	Adjustable	Triggered	Operating	Auto	ON
Low pressure	Adjustable	Triggered	Operating	Auto/Manual	ON/Blinking
Freezing	Adjustable	Triggered	Fully closed	Auto/Manual	ON/Blinking

Technical Data

Supply voltage	24VAC/DC \pm 10%
Power consumption	EXD-HP1: Max. 15VA EXD-HP2: Max. 20VA
Digital inputs	EXD-HP1: Two, each potential free EXD-HP2: Three, each potential free
Relay output	SPDT contacts, AgSnO Inductive (AC15) 24V AC: 1Amp Resistive: 24 V AC/DC: 4Amps
Plug-in connector size	Removable screw version wire size 0.14 ... 1.5mm ²
Applied directive	LVD, EMC, RoHS, VDE
Compliance with	DIN EN 60335-1, DIN EN 55014-1 DIN EN 55014-2

Protection class	IP 20
Housing	Self extinguishing ABS
Mounting	DIN rail mounted
Temperatures storage operating	-20 ... +65°C -10 ... +60°C
Relative humidity	0 ... 85% RH non condensing
Weight	175 g
Marking	CE, VDE (pending) and Gost

Input Sensors, Output Valves

Description	Specification
Temperature input	ECP-P30 (3 meter cable length) Range: -30°C to +150°C
Pressure sensor input	PT5/PT6 Signal: 4 ... 20mA
Electronic expansion valves (stepper motor) output	EXM and EXL series with 12V coil

EXD-TEVI Economizer Controller for Tandem Compressors

EXD-TEVI is a stand-alone controller for enhanced wet vapor injection for Copeland Scroll™ tandem compressors in heating applications.

Features EXD-TEVI

- Emerson solution for specified operating map of tandem scroll
- Two EXL valves can be driven in parallel for required wide injection capacity
- Input signals: Injection (intermediate) pressure and temperature sensor as well as two compressor discharge temperature sensors
- Two independent digital inputs for recognition of tandem compressors operation
- High discharge temperature alarm
- Monitoring of sensors and sensor wiring and detection of sensor wiring failures
- Controllers as slave with Modbus (RTU) communication capability
- Upload/download key (accessory) allows to copy parameter settings from one controller to others
- Integrated 3½ digit 7-segment display with 6 indicator LEDs
- Electrical connection via plug-in type screw terminals (included with controller)
- DIN rail mounting housing



EXD-TEVI

Selection table

Description	Type	PCM	
		Multipack (20 pieces)	Singlepack
Controller with connectors	EXD-TEVI	807 838M	807 838
Injection line temperature sensor	ECN-N30 (3 meter cable)	-	804 496
	ECN-N60 (6 meter cable)	-	804 497
Injection line pressure transmitter	PT5-30M (flare connection)	802 352M	802 352
	PT5-30T (brazed connection)	802 382M	802 382
Plug and cable assembly for pressure transmitters	PT4-M15 (1.5 meter cable)	804 803M	804 803
	PT4-M30 (3 meter cable)	804 804M	804 804
Electronic expansion valve body	EXL-B1F	800405M	-
	EXL-B1G	800406M	-
Electronic expansion valve coil	EXL-125	800407M	-

Remark: Discharge temperature sensor (86 kΩ NTC) is part of compressor delivery.

Technical Data

Supply voltage	24VAC/DC \pm 10%
Power consumption	EXD-TEVI: Max. 20VA
Digital inputs	2 (potential free)
Relay output (Alarm)	SPDT, with AgSnO contacts Inductive (AC15) 24V AC: 1A Resistive: 24 V AC/DC: 4A
Plug-in connector size	Removable screw version wire size 0.14 ... 1.5mm ²
Applied directive	LVD, EMC, RoHS
Compliance with	DIN EN 60335-1, DIN EN 55014-1 DIN EN 55014-2

Protection class	IP 20
Housing	Self extinguishing ABS
Mounting	DIN rail mounted
Temperatures storage operating	-20 ... +65°C -10 ... +60°C
Relative humidity	0 ... 85% RH non condensing
Weight	175 g
Marking	CE

Technical data: Sensors

Description	Specification
Temperature sensors	1 x 10k NTC for injection line temperature (ECN-N30 / ECN-N60) 2 x 86k NTC for discharge gas temperature (part of compressor delivery)
Pressure transmitter EVI	PT5-30M/T: 4-20 mA (Range: 0 to 30 bar)

Wiring Diagram EXD-TEVI

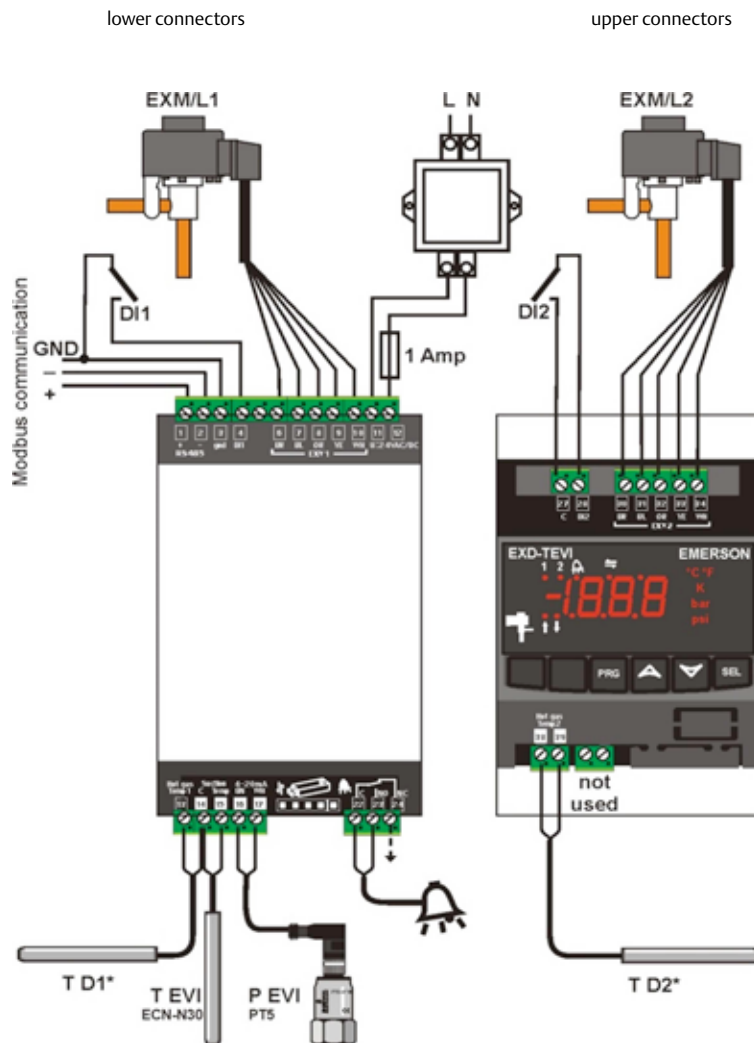

Notes:

- Alarm relay, dry contact. Relay coil is not energized at alarm condition or power off and energized during normal operation
- Transformer shall be class 2
- *The discharge temperature sensors would be part of compressor delivery

Compressor Soft Starter CSS-25U / CSS-32U / CSS-32W

The Compressor Soft Starter CSS-25U / CSS-32U / CSS-32W is used for switching, protecting and starting current limitation of single phase compressors in residential heat pump applications.

Features

- For motors with maximum operating current up to 25A/32A
- Limitation of starting current to less than 45 A; PCN 805209 less than 30 A
- Self-adjusting for use in 50 Hz or 60 Hz supply
- Self-adjusting to motor current - no manual adjustment or calibration necessary
- Alarm relay output
- Start capacitor for improved motor acceleration is switched off after start
- Low voltage shutdown
- Locked rotor recognition and shutdown
- Delay function to limit number of motor starts per hour
- Thyristor protected contactor for long life
- No extra motor contactor needed
- Self-diagnostics
- Mounting clip for easy installation allows DIN rail mounting in two directions
- Easy connection by cage type screw terminals wire Ø 4mm (Ø 6mm for 805211)



CSS-32W

CE Standards:

- LVD 2006/95/EC Low Voltage Directive
- EN 60947-1 Low voltage switchgear and controlgear
- EN 60947-4-2 Contactors and motor-starters - AC semiconductor motor controllers and starters
- **EN 60335-1, EN 60335-2-40: Safety of household and similar electrical appliances (PCN 805 204 and 805 205 only , confirmed and certified by independent test lab VDE.)**
- EMC 2004/108/EC
- ROHS 2002/95/EC

Selection Chart CSS

Type	Part No.	Part No. (20 pieces)	Description	I max
CSS-32U	805 204	805 204 M	Soft Starter incl. mounting clip, VDE released version	32A
CSS-32W	805 211	805 211 M	Soft Starter with 6mm power terminals R, RC and L incl. mounting clip, VDE released version	32A
CSS-25U	805 205	805 205M	Soft Starter incl. mounting clip, VDE released version	25A
CSS-25U	805 209	805 209M	Soft Starter incl. mounting clip	25A
K00-003	807 663	-	3-pol Screw connector to alarm output for wires up to 2.5mm ² ; bag with 50 pieces	

Technical Data

Operating voltage	230 V 50/60 Hz nominal
Nominal compressor current	CSS-32U / - 32W: 32A max. CSS-25U: 25A max.
Maximum start current	CSS-32U / -32W: 45A CSS-25U (805 205): 45A CSS-25U (805 209) 30A
Operating temperature	-20 ... +55°C non condensing
Storage temperature	-20 ... +65°C non condensing
Start capacitor	200 ... 240 uF
Time delay after stop	0,5 ... 5 Min

Alarm relay, AgNi (SPDT)	
Resistive (AC1) max.	250V~ / 3A 30V= / 3A
Flexible cable cross section CSS-32U/-25U all terminals CSS-32W (R, RC, L terminals)	0.25 ... 4 mm 0.25 ... 6 mm
Flexible cable cross section alarm output connector K00-003	0.25 ... 2.5 mm
Max. vibration (at 10 ... 1000 Hz)	4 g
Weight	430 g
Protection acc. IEC 529	IP 20

Wiring Diagram

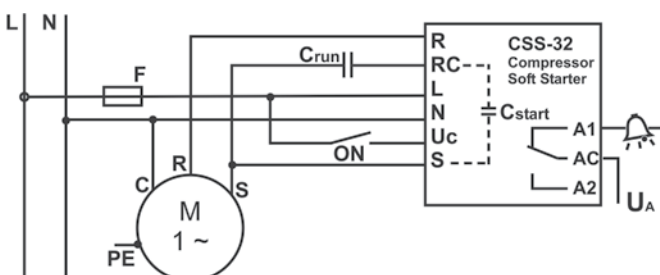

CSS Contacts:

- R = Output motor run winding
- RC = Output run capacitor
- L = 230V / AC power input
- N = Neutral line
- Uc = Start input (ON if connected to 230V)
- S = Output start winding from start capacitor
- A1, AC, A2 = Alarm relay contact

Pressure Transmitter PT5

PT5 Pressure Transmitters convert a pressure into a linear electrical 4..20mA output signal suitable for controlling simple compressor and fan switching to the more sophisticated application of superheat modulation of Electronic Control Valves.

With competitive performance to price characteristics and an easy to install pre-fabricated M12 cable assembly, PT5 transmitters are the designers choice for all heat pump, refrigeration and air conditioning applications.

Features

- Piezo-resistive sensor with output signal 4 to 20 mA and 2-wire connection for the precise operation of superheat, compressor or fan control systems
- Specially calibrated pressure ranges with $\pm 1\%$ accuracy performance to fulfill demands of today's refrigeration and HVAC applications
- Fully hermetic
- PT5-xxM with $\frac{7}{16}$ "-20UNF pressure connection and Schrader valve opener
- PT5-xxT with 6mm x 40mm stainless steel tube and integrated brazing neck for easy mounting in applications requiring a fully hermetic system solution
- PT5-150D with pressure connection $\frac{1}{4}$ " NPT (M) suitable for subcritical and transcritical CO2 systems
- Vibration, shock and pulsation resistant
- Protection class IP65 / IP67 (type-specific)
- UL (File No. E258370)



PT5-xxM
with PT4-Mxx Cable Assembly



PT5-150D



PT5-xxT

Selection Table

Type	Part No.		Pressure range for signal output (bar)*	Output signal	Medium Temp. Range at pressure connection (°C)	PS: Max. working pressure (bar)*	PT: Test pressure (bar)*	Burst pressure (bar)*	Pressure Connection
	Single pack	Multi-pack**							
PT5-07M	802 350	802 350M	-0.8 .. 7	4 .. 20 mA	-40 .. +100	27	30	150	$\frac{7}{16}$ " - 20 UNF (with Schrader valve opener)
PT5-18M	802 351	802 351M	0 .. 18			55	63	250	
PT5-30M	802 352	802 352M	0 .. 30			60	100	400	
PT5-50M	802 353	802 353M	0 .. 50			100	150	400	
PT5-07T	802 380	802 380M	-0.8 .. 7		-40 .. +135	27	30	150	6mm tube x 40mm long
PT5-18T	802 381	802 381M	0 .. 18			55	63	250	
PT5-30T	802 382	802 382M	0 .. 30			60	100	400	
PT5-50T	802 383	802 383M	0 .. 50			100	150	400	
PT5-150D	802 379	-	0 .. 150	-40 .. +100	220	320	1000	$\frac{1}{4}$ " NPT (M)	

*) Sealed gauge pressure

**) PT5xxM: 20 pcs, PT5-xxT: 10 pcs

Selection Plug/Cable Assemblies: assembly fits all models

Type	Part No.		Cable Length	Weight (g/piece)	Temperature Range
	Single pack	Multipack** 20 pcs			
PT4-M15	804 803	804 803M	1.5 m	50	-50 ... +80°C static application -25 ... +80°C mobile application
PT4-M30	804 804	804 804M	3.0 m	80	
PT4-M60	804 805	804 805M	6.0 m	140	

Technical Data Pressure Transmitter

Supply voltage (polarity protected)	Nominal: 24Vdc Range: 7.. 30Vdc PT5-150D: 7 .. 26.4Vdc	Sensor lifetime	30 million load cycles with 1.3 times of nominal pressure
Permissible noise & ripple Influence of supply voltage	< 1 Vp-p < 0,02 %FS/V	Electrical connection PT4-Mxx Cable Assembly	M12 connection according to EN61076-2-101 Part 2 Prefabricated, various cable lengths
Operating current	Maximum \leq 24 mA 4 to 20 mA output	Medium compatibility	CFC, CHFC, HFC, CO ₂ Not released for use with caustic, flammable substances or ammonia!
Load resistance	$R_L \leq U_b - 7.0V$ 0.02A	Approvals/Marking	CE: 2004/108/EEC, EN 61326 Emission (Group 1; Class B) and immunity (industrial locations) UL, cRUus (UL File Nr. E258370) GOST for Russian markets
Response time	\leq 5 ms	Protection class (EN 60529)	PT5-07, -18: IP65 with plug PT5-30, -50, -150: IP67 with plug
Weight (without plug and cable ass.)	PT5-xxM, -150D: ~ 80 g PT5-xxT: ~ 60 g	Vibration at 10...2000Hz	20 g according to IEC 60068-2-6
Mounting position	Non position sensitive; details see operating instructions	Materials Housing, pressure connector and diaphragm with medium contact Electrical connector	Stainless steel 316L, 1.4534 1.4301 (PT5-xxT) Highly resistive, fibreglas-enforced plastic PBTF30
Temperatures Transport and storage Operating ambient housing Medium: PT5-xxM, -150D PT5-xxT	-25 .. +80 °C -40 .. +80 °C -40 .. +100 °C -40 .. +135 °C		

*) Total error includes non-linearity, hysteresis, repeatability as well as offset and span drift due to the temperature changes.
Note: % FS is related to Percentage of Full sensor Scale.

Accuracy Performance

Type	Total error *	Temperature range
PT5-07 / 18	\pm 1% FS	-40 ... +20 °C
PT5-30 / -50/	\pm 1% FS \pm 2% FS	+10 ... +50 °C -10 ... +80 °C
PT5-150D	\pm 1% FS \pm 2% FS	+10 ... +50 °C -10 ... +100 °C

Electrical connections

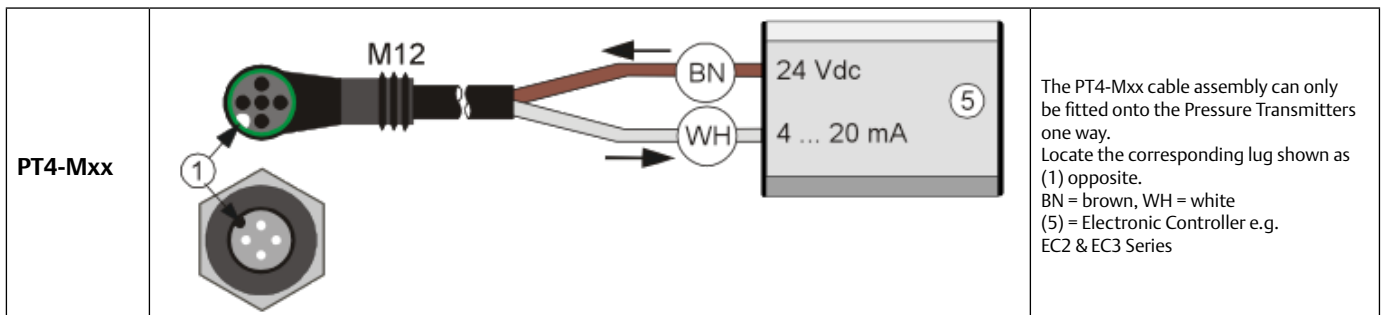

Pressure Transmitter PT6

The PT6 series of Pressure Transmitters convert a pressure into a linear electrical 4 .. 20mA output signal suitable for controlling simple compressor and fan switching to the more sophisticated application of superheat modulation of EX series Electrical Control Valves.

Features

- Sensitive pressure cells with strong primary output signals for the precise operation of superheat, compressor or fan controls systems
- Ceramic cell with gasket
- Pressure connector 7/16"-20 UNF with Schrader valve opener
- Output signal 4 to 20 mA
- Standard pressure ranges compatible with former Emerson pressure transmitters - Sealed gauge pressure
- Calibrated at pressure and temperature ranges to fulfill demands of today's refrigeration and HVAC applications
- Reduced Full Scale Error characteristics over the complete temperature range
- Easy install M12 electrical connection with pre-assembled cable assemblies available in various lengths
- Protection class IP 65
- Vibration, shock and pulsation resistant
- CE-mark under EC EMC-Directive
- UL listed. File Nr. E258370
- **OEM product: available in multipacks with 20 pieces only**



PT6-xxM



PT4-Mxx Cable Assembly

Selection Chart, Pressure Transmitters

Type	Part No. Multipack 20 pcs	Pressure range for signal output (bar)*	Output signal	Medium temperature range (°C)	PS: Max. working pressure (bar)*	PT: Test pressure (bar)*	Burst pressure (bar)*	Pressure Connection
PT6-18M	802 361M	0 ... 18	4 ... 20 mA	-40 ... + 100	36	40	54	7/16" – 20 UNF (with Schrader valve opener)
PT6-30M	802 362M	0 ... 30			60	100	120	
PT6-50M	802 363M	0 ... 50			100	150	200	

*) Sealed gauge pressure

Selection Chart, Plug/Cable Assemblies: assembly fits all models

Type	Part No.		Length	Weight (grams/pcs)	Temperature Range
	Individually packaged	Multipack 20pcs			
PT4-M15	804 803	804 803M	1.5 m	50	-50 to +80°C static application -25 to +80°C mobile application
PT4-M30	804 804	804 804M	3.0 m	80	
PT4-M60	804 805	804 805M	6.0 m	140	

Technical Data

Supply voltage Nominal Range (polarity protected)	24Vdc 7.. 30Vdc	Sensor lifetime	≥ 10.000.000 cycles with 1.0 nominal pressure
Permissible noise & ripple Influence of supply voltage	< 1 Vp-p < 0,02 %FS/V	Burst pressure	See selection chart
Operating current	Maximum ≤ 24 mA 4 to 20 mA output	Medium compatibility not suitable for ammonia and inflammable refrigerants!	HFC, HCFC, CFC
Load resistance	$R_L \leq U_b - 7.0V$ 0.02A	Approvals CE conformity CE marking according to EMC	97/32/EC CE marked according to 2004/108/EEC, EN 61326 (Certificate upon request)
Response time	≤ 5 ms	Marking (UL File Nr. E258370)	CE and UL
Weight (without plug and cable ass.)	80 g	Vibration at 10...2000Hz	20g according to IEC 68-2-6
Mounting position	Refer to operating instructions for more details	Materials Housing, pressure con- nector and diaphragm with medium contact Electrical connector	Brass sealing CR70, Ceramic sensor cell AL2O3 96% Highly resistive, fibreglas-enforced plastic (PBTGF30)
Temperatures Operating ambient housing Medium Transport and storage	-40 .. +80 °C -40 .. +100 °C -20 .. +80 °C	Protection class (EN 60529)	IP65 with plug
Packaging and Delivery	Multipacks only (20 pieces)		

*) Total error includes non-linearity, hysteresis, repeatability as well as offset and span drift due to the temperature changes.
Note: %FS is related to Percentage of Full sensor Scale.

Accuracy Performance

Type	Total error *	Temperature range
PT6-18M	≤ ±1.5% FS	-20.... +20 °C
PT6-30M	≤ ±1.5% FS ≤ ±2% FS Typically ≤ ±2% FS	0 +40 °C -20 +60 °C -20 +80 °C
PT6-50M	≤ ±1% FS ≤ ±2% FS Typically ≤ ±2% FS	0 +40 °C -20 +60 °C -20 +80 °C

Electrical connections

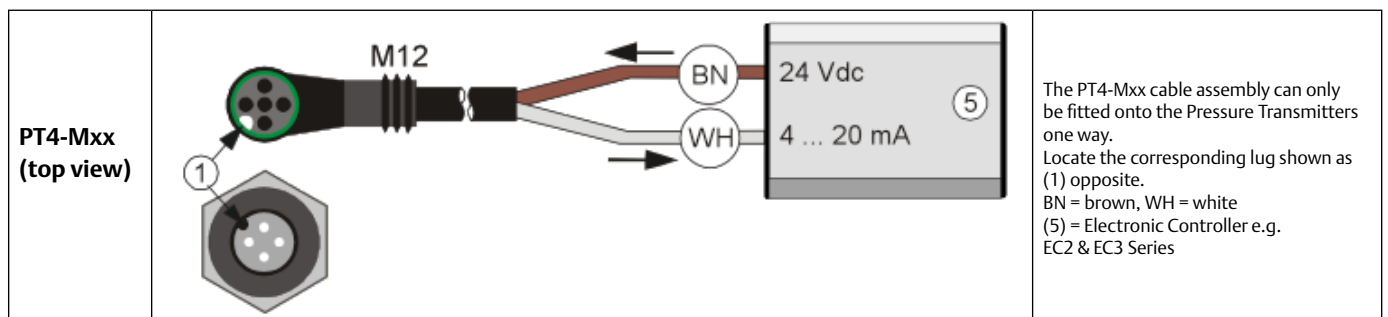

Electronic Fan Speed Controller Series FSY

Features

- Pressure actuated fan speed control
- Adjustable pressure for cut-off
- High Voltage Triac (800 Volts)
- Integrated protection circuit against voltage peaks
- Compact design
- Protection IP65
- Easy mounting and adjustment
- Easy retrofit in existing systems
- No additional gasket required (completely molded into plug)
- Multi-position plug with EMC filter incl. 1,5m (opt. 3 and 6m) cable for flexible installation
-  per EC 89/336/EC (together with FSF cable)
- UL file E183816
- Other pressure connection upon request (minimum order volume 100 pieces)



FSY-43S

Selection Table

Type	Part No.	Operational Current A	Adjustment Range bar	Factory Setting bar	Max. Operating Pressure PS bar	Test Pressure PT bar	Pressure Connection
FSY-41S	0 715 533	0.1 ... 4	4.0 ... 12.5	8.0	27	30	S: 7/16"-20 UNF female
FSY-42S	0 715 534		9.2 ... 21.2	15.0	32	36	S: 7/16"-20 UNF female
FSY-43S	0 715 537		12.4 ... 28.4	21.8	45	50	S: 7/16"-20 UNF female

Cable Assemblies with Plug and EMC Filter

Type	Part No.	Temperature range (°C)	Cable length (m)	 <p>FSF-N15</p>
FSF-N15	804 640	-50 .. +80	1.5	
FSF-N30	804 641		3.0	
FSF-N60	804 642		6.0	

Technical Data

Supply voltage	230 AC, +15%, -20%, 50/60 Hz														
Nominal current (see diagram below)	0.1 ... 4 (3) A														
Starting current	max. 8 Amps/5 sec.														
Medium compatibility	HFC, HCFC (not released for use with inflammable refrigerants)														
Protection Class according to IEC529 /EN 60529	IP 65 (with fitted connectors FSF-xxx)														
Temperature ranges °C Ambient	-20 to +55°C (>40°C see diagramm)														
Storage & transportation Medium	-30 to +70°C -20 to +70°C														
<p style="text-align: center;">Max. Current vs Ambient Temperature</p> <table border="1"> <caption>Data for Max. Current vs Ambient Temperature</caption> <thead> <tr> <th>Ambient Temperature (°C)</th> <th>Current (A)</th> </tr> </thead> <tbody> <tr><td>30</td><td>4.0</td></tr> <tr><td>35</td><td>4.0</td></tr> <tr><td>40</td><td>4.0</td></tr> <tr><td>45</td><td>3.5</td></tr> <tr><td>50</td><td>3.0</td></tr> <tr><td>55</td><td>2.5</td></tr> </tbody> </table>		Ambient Temperature (°C)	Current (A)	30	4.0	35	4.0	40	4.0	45	3.5	50	3.0	55	2.5
Ambient Temperature (°C)	Current (A)														
30	4.0														
35	4.0														
40	4.0														
45	3.5														
50	3.0														
55	2.5														

Pressure change per turn of adjustment screw	FSY-41: 4,0 .. 12.5 bar clockwise ~ +1.2 bar counterclockwise ~ -1.2 bar
	FSY-42: 9,2 .. 21.2 bar clockwise ~ +2.5 bar counterclockwise ~ -2.5 bar
	FSY-43: 12,4 .. 28.4 bar clockwise ~ +3.3 bar counterclockwise ~ -3.3 bar
Proportional Range	FSY-41: 2.5 bar FSY-42: 3.8 bar FSY-43: 4.6 bar
Weight	approx.
FSY-41, -42	0.12 kg
FSY-43	0.15 kg
FSF-N15	0.14 kg
FSF-N30	0.20 kg
FSF-N60	0.22 kg
Housing material	PC and PA

Function Diagram

The control behaviour can be easily described by looking at the function of output voltage versus input pressure: In the **maximum range** the FSY provides a constant output voltage of approximately 1% below the supply voltage. The fan is running at maximum speed. Along the **proportional range**, the output voltage varies between maximum and minimum voltage of approximately 50% of the supply voltage. This causes the fan to slow down from maximum to minimum speed.

Further decrease of pressure in the minimum range leads to cut-off of the fan motor. Reincrease of input pressure will start the motor with a hysteresis of approximately 0.7 bar to avoid cycling. The pressure from which motor cuts off is adjustable (see selection table - adjustment range).

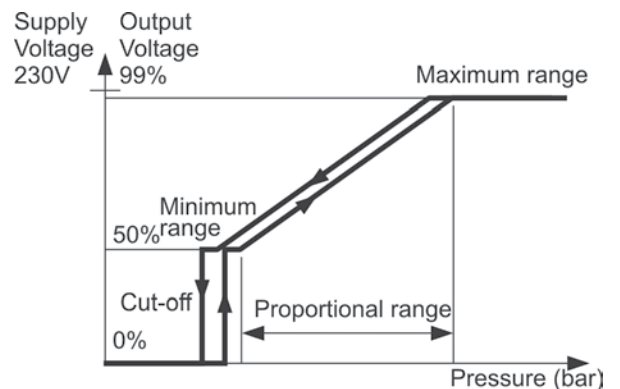

FSE Fan Speed Control Module

Electronic Fan Speed Control Modules FSE generate a 0...10V signal, which is used to control the speed of condenser fan motors in commercial refrigeration and air-conditioning systems. Ideal for use with high efficient EC-motors, but can be also used with phase cut controllers for induction motors.

Features

- Energy saving due to improved cooling efficiency
- Pressure for minimum speed adjustable
- Small proportional band and large hysteresis to minimize cycling at small pressure changes
- Reduced fan noise level during low ambient temp. conditions
- Improved overall performance of cooling system
- Easy installation with cables for power supply and motor connection factory wired
- IP 65 protection for outdoor mounting
- UL file nr.: E355325



FSE Control Modules

Selection Chart Control Modules FSE

Type	Part No.	Refrigerants	Adjustment Range PCut (bar) *	Cut-off Pressure factory set (bar)	Test Pressure	Pressure Connection	Weight (g)
FSE-01S	804 701	R134a	4 ... 12.5	7.8	30 bar	3/16" -20 UNF female	125
FSE-02S	804 706	R22, R407C, R404A, R507	10 ... 21	15.5	36 bar	3/16" -20 UNF female	125
FSE-03S	804 711	R410A	12 ... 28	20.4	50 bar	3/16" -20 UNF female	150

Cable Assemblies for connection of FSE Control Module to controller

Type	Part No.	No of leads	Diameter of leads	Temperature Range °C	Cable length mtr.
PS3-N15	804 580	3	0.75 mm ²	-25/+80	1.5
PS3-N30	804 581				3.0
PS3-N60	804 582				6.0

Technical Data FSE

Supply Voltage	10V; supplied by controller
Operating current 0...10 VDC output	max. 1 mA
Medium compatibility	HFC, HCFC, POE-, synthetic and mineral oils
Protection class (IEC529/EN 60529)	IP 65 with cable connector assemblies PS3-Nxx

Pressure connection FSE-01S and FSE-02S FSE-03S	Brass Stainless Steel
Max. operating pressure PS	FSE-01S: 27bar FSE-02S: 32bar FSE-03S: 45bar
Temperature Range Storage and transportation Operation	-30° ... +70°C -20° ... +65°C
Materials Housing cover	PA

Thermo™-Expansion Valves

Thermo™-Expansion Valves

Basic Terms and Technical Information

Operating principles

Alco Thermo-Expansion valves control the superheat of refrigerant vapor at the outlet of the evaporator. They act as a throttle device between the high pressure and the low pressure sides of refrigeration systems and ensure that the rate of refrigerant flow into the evaporator exactly matches the rate of evaporation of liquid refrigerant in the evaporator. Thus the evaporator is fully utilized and no liquid refrigerant may reach the compressor.

Description of bulb charges

The application ranges of Thermo-Expansion valves are heavily influenced by the charge selected.

Liquid charges

The behaviour of Thermo-Expansion valves with liquid charges is exclusively determined by temperature changes at the bulb and not subject to any cross-ambient interference. They feature a fast response time and thus react quickly in the control circuit. Liquid charges cannot incorporate MOP functions. Maximum bulb temperatures shall not exceed 75°C.

Gas charges

The behaviour of Thermo-Expansion valves with gas charges will be determined by the lowest temperature at any part of the expansion valve (power assembly, capillary tube or bulb). If any parts other than the bulb are subject to the lowest temperature, malfunction of the expansion valve may occur (i.e., erratic low pressure or excessive superheat). Alco Thermo-Expansion valves with gas charges always feature MOP functions and include ballasted bulbs. Ballast in the bulb leads to slow opening and fast closure of the valve. Maximum bulb temperature is 120°C.

Adsorption charges

These charges feature control characteristics much like MOP charges but avoid the difficulties of cross-ambient interference. Response time is slow but perfectly suitable for common refrigeration systems. Maximum bulb temperature is 130°C.

MOP (Maximum Operating Pressure)

MOP functionality is somewhat similar to the application of a crankcase pressure regulator. Evaporator pressures are limited to a maximum value to protect compressor from overload conditions. MOP selection should be within maximum allowed low pressure rating of the compressor and should be at approximately 3K above evaporating temperatures.

Practical hint: Superheat adjustments influence the MOP:

Increase of superheat: Decrease of MOP
Decrease of superheat: Increase of MOP

Static superheat

Alco Thermo-Expansion valves are factory preset for optimum superheat settings. This setting should be modified only if absolutely necessary. The readjustment should be at the lowest expected evaporating temperature.

Subcooling

Subcooling generally increases the capacity of the refrigeration system and may be accounted for when dimensioning an expansion valve by applying the correction factor K_c . The capacity corrections for evaporating temperature, condensing temperature and subcooling are all incorporated in K_c . These are, in particular the liquid density upstream from the expansion valve, the different enthalpies of liquid and vapor phase refrigerants, as well as certain parts of flash gas after expansion. The percentage of flash gas differs with various refrigerants and depends on system conditions.

Heavy subcooling results in very small flash gas amounts and therefore increases expansion valve capacities. These conditions are not covered by K_c . Likewise, small flash gas amounts lead to reduced evaporator capacities and may result in substantial discrepancies between the capacities of the Thermo-expansion valve and the evaporator. These effects must be considered during component selection when designing refrigeration circuits. In cases when subcooling exceeds 15 K, sizing of components (K_c , $K\Delta p$) should be modified accordingly. The field practice indicates the following correction factors can be used to compensate the effect of the subcooling (liquid hammering) in addition to the use of correction factors K_c , and $K\Delta p$.

Subcooling	20K	30K	40K	50K	60K
Correction factor	0.8	0.7	0.6	0.5	0.4

Emerson Climate Technologies will be happy to assist you. Please contact the application engineering department.

Dimensioning

To correctly select a Thermo-Expansion valve on a system, the following design conditions must be available:

- Cooling capacity Q_o
- Effective pressure differential across Thermo-Expansion valve Δp
- Evaporating temperature/pressure
- Lowest possible condensing temperature/pressure
- Liquid temperature
- Type of refrigerant

As opposed to single substances (e.g. R134a etc.) where the phase change takes place at a constant temperature/pressure, the evaporation and condensation of **zeotropic blend R407C** is in a gliding form (e.g., at a constant pressure the temperature varies within a certain range) through evaporators and condensers. The evaporating/condensing pressure must be determined at saturated temperatures (bubble/dew points) for dimensioning of Thermo-Expansion valves.

To facilitate valve dimensioning for other than standard conditions, Emerson Climate Technologies offers Copeland Select which can be downloaded from www.emersonclimate.eu See www.emersonclimate.eu for contact addresses, email, phone numbers or downloads.

Example

Cooling capacity of a system:	18 kW
Refrigerant:	R407C
Condensing temperature (saturated liquid):	+35°C
(Condensing pressure will be 15.5 bar)	
Evaporating temperature (saturated vapor):	0°C
(Evaporating pressure will be 4.61 bar)	
Subcooling:	1 K
Pressure drops through liquid line:	2.2 bar
Pressure drops through evaporator:	0.3 bar
Required type of Thermo-Expansion valve:	T-series

To calculate the nominal capacity the following formula has to be used:

$$\text{Cooling capacity} \times K_t \times K_{\Delta p} = \text{Nominal capacity}$$

1. Selected K_t -factor according to refrigerant, liquid and evaporating temperature from "Correction Tables for Thermo-Expansion Valves Series TI, TX3, TX6, T and L" in this chapter.

$$K_t = 0.98 \text{ (for this example)}$$

2. Determine pressure differential across the Thermo-Expansion valve using condensing pressure. subtract evaporating pressure and all other possible pressure losses (pressure drops in evaporator, drier, solenoid valve, liquid distribution...).

For this example:

$$\Delta p = 15.5 - (4.61 + 2.2 + 0.3) = 8.39 \text{ bar}$$

Select $K_{\Delta p}$ factor from "Correction Tables for Thermo-Expansion Valves Series TI, TX3, TX6, T and L" in this chapter:

$$K_{\Delta p} = 1.15 \text{ (for this example)}$$

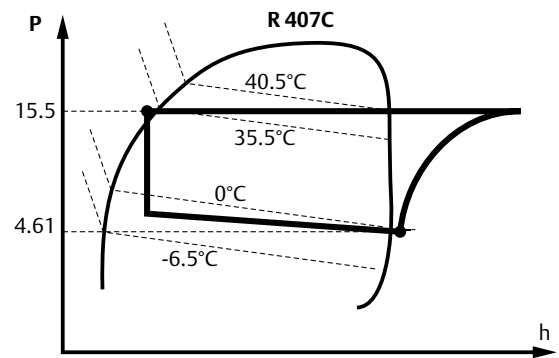

3. Multiply cooling capacity with K_t and $K_{\Delta p}$ to find nominal capacity for Thermo-Expansion valve.

$$Q_n = 18 \times 0.98 \times 1.15 = 20.29 \text{ kW}$$

Select Thermo-Expansion Valve from table on page "Thermo-Expansion Valve Series T": TCLE 550 NW (for this example).

Please note that all evaporating/condensing temperatures in this catalogue are based on saturated vapor/liquid temperatures.

Selection Guide for Expansion Valves

Series	Selection Criteria			
	Capacity Range kW (R 404A)	Evaporating Temp. Range °C	Main Application	Features
TI	0.4 to 14.2	+20 to -45	Refrig./Air Cond. Heat Pumps	Exchangeable Orifices
TX3	0.8 to 15.0	+20 to -45	Refrig./Air Cond. Heat Pumps	Hermetic, Superheat adjustable, optional with check valve
TX6	13.3 to 57.0	+20 to -45	Air-Cond. Heat Pumps	Hermetic, Superheat adjustable
T	2 to 209	+30 to -45	Refrig./Air Cond. Heat Pumps	Exchangeable Orifices, Power-Assembly and Flange
ZZ	1.9 to 81.2	-45 to -120	Low Temperature Application	Exchangeable Orifices, Power-Assembly and Flange
L	2 to 154	+30 to -50	Liquid Injection Superheat Control	Exchangeable Orifices, Power-Assembly and Flange
935	5.2 to 43.5	+30 to -45	Liquid Injection Temperature Control	Exchangeable Orifices, Power-Assembly and Flange

Thermo™ -Expansion Valves Series TI

New valve design, exchangeable orifices

Features

- Laser-welded diaphragm with large diameter for high reliability and maximum lifetime
- Constant superheat across wide application ranges Easy and precise superheat setting by modified threads
- TILE with stainless steel fittings allow brazing without wet rags
- With capacities between 0.4 kW and 14.2 kW (R404A) ideally suited for service work
- Internal or external equaliser
- Brazing and flare connections available
- Capillary tube length 1.5 m
- PS: 45 bar. TS: -45 ... +75°C
- No CE marking according art. 3.3 PED 97/23 EC



TILE



TIE

Type Code

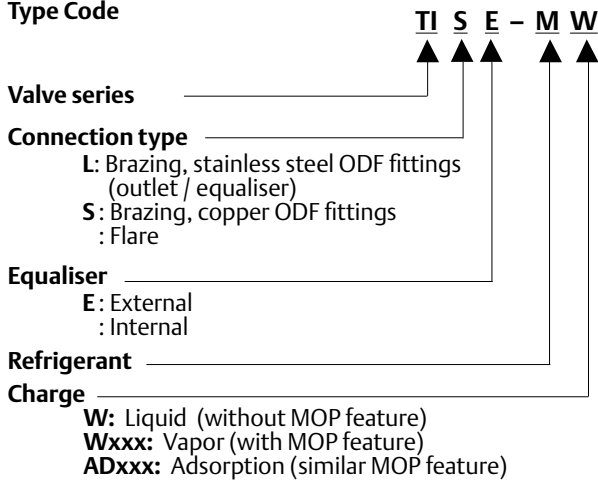

Orifice Assembly with strainer for inlet connection

Type	Nominal Capacity* (kW)							
	TIO-00X	TIO-000	TIO-001	TIO-002	TIO-003	TIO-004	TIO-005	TIO-006
Part No.	800 532	800 533	800 534	800 535	800 536	800 537	800 538	800 539
R134a	0.3	0.8	1.9	3.1	5.0	8.3	10.1	11.7
R22	0.5	1.3	3.2	5.3	8.5	13.9	16.9	19.5
R404A	0.4	1.0	2.3	3.9	6.2	10.1	12.3	14.2
R407C	0.5	1.4	3.5	5.7	9.2	15.0	18.3	21.1
R410A	0.6	1.5	3.7	6.2	9.9	16.2	19.7	22.8
R507	0.4	1.0	2.3	3.9	6.2	10.1	12.3	14.2
R407F	0.6	1.5	3.6	5.9	9.5	15.5	18.9	21.8

Brazing Adapter for TILE and TIS(E)

Type	Part No.	Connection, ODF	
		mm	inch
TIA-M06	802 500	6.0	-
TIA-M10	802 501	10.0	-
TIA-014	802 502	-	¼"
TIA-038	802 503	-	⅜"
Gasket Set	803 780	100 pieces	



*Nominal capacity is based on the following conditions:

Refrigerant	Evaporating temperature	Condensing temperature	Sub-cooling
R407C, R407F	+4°C dew point	+38°C bubble p. +43°C dew point	1K
R22, R134a, R404A, R410A, R507	+4°C	+38°C	1K

Valve selection for other operating conditions see "Correction Tables for Thermo-Expansion Valves Series TI, TX3, TX6, T and L", quick selection tables on next pages or Copeland Select which can be downloaded from www.emersonclimate.eu.

TI Valve Bodies without cage and nut

Refrigerant	Outlet/ Equalizer Connection	Type	Part No.	Type	Part No.	MOP °C	Evaporating temperature range °C
		external Equalizer		internal Equalizer			
R404A / R507	Brazing stainless steel	TILE-SW (12mm)	802465			-	-45 ... +20
		TILE-SW (½")	802466			-	-45 ... +20
	Brazing copper	TISE-SW (12mm)	802462	TIS-SW (12mm)	802461	-	-45 ... +20
		TISE-SW (½")	802464	TIS-SW (½")	802463	-	-45 ... +20
		TISE-SAD10 (½")	802479	TIS-SAD10 (½")	802478	+10	-45 ... 0
		TISE-SW75 (12mm)	802471			0	-45 ... -3
		TISE-SW75 (½")	802472			0	-45 ... -3
		TISE-SAD-20 (12mm)	802474			-20	-45 ... -27
	Flare	TISE-SAD-20 (½")	802475			-20	-45 ... -27
		TIE-SW	802460	TI-SW	802459	-	-45 ... +20
		TIE-SAD10	802477	TI-SAD10	802476	+10	-45 ... 0
		TIE-SW75	802470	TI-SW75	802469	0	-45 ... -3
		TIE-SAD-20	802473		-20	-45 ... -27	
R134a	Brazing stainless steel	TILE-MW (12mm)	802451			-	-45 ... +20
		TILE-MW (½")	802452			-	-45 ... +20
	Brazing copper	TISE-MW (12 mm)	802448	TIS-MW (12 mm)	802447	-	-45 ... +20
		TISE-MW (½")	802450	TIS-MW (½")	802449	-	-45 ... +20
		TISE-MW55 (12mm)	802457			+14	-45 ... +11
	Flare	TISE-MW55 (½")	802458			+14	-45 ... +11
		TIE-MW	802446	TI-MW	802445	-	-45 ... +20
		TIE-MW55	802456	TI-MW55	802455	+14	-45 ... +11
R407C	Brazing stainless steel	TILE-NW (12mm)	802486			-	-45 ... +20
		TILE-NW (½")	802485			-	-45 ... +20
	Brazing copper	TISE-NW (12mm)	802438	TIS-NW (12mm)	802437	-	-45 ... +20
		TISE-NW (½")	802440	TIS-NW (½")	802439	-	-45 ... +20
	Flare	TIE-NW	802436	TI-NW	802435	-	-45 ... +20
R22	Brazing stainless steel	TILE-HW (12mm)	802426			-	-45 ... +20
		TILE-HW (½")	802427			-	-45 ... +20
	Brazing copper	TISE-HW (12mm)	802423	TIS-HW (12mm)	802422	-	-45 ... +20
		TISE-HW (½")	802425	TIS-HW (½")	802424	-	-45 ... +20
		TISE-HW100 (12mm)	802431			+15	-45 ... +13
	Flare	TISE-HW100 (½")	802432			+15	-45 ... +13
		TIE-HW	802421	TI-HW	802420	-	-45 ... +20
		TIE-HAD10	802430		+10	-45 ... 0	
R410A	Brazing stainless steel	TILE-ZW (12mm)	802488			-	-35 ... +20
		TILE-ZW (½")	802489			-	-35 ... +20
		TILE-ZW175 (12mm)	802490			+16.4	-35 ... +15
		TILE-ZW175(½")	802491			+16.4	-35 ... +15

Inlet: Flare ⅜"-18UNF for 6mm, 8mm., 10mm, ¼", ⅝" and ¾" tubes
 Outlet: Flare ¾"-16UNF for 12mm and ½" tubes.
 Solder metric: ODF for 12mm tubes. Solder inch: ODF for ½" tubes
 Ext. Equalizer: Flare ⅝"-20UNF for 6mm and ¼" tubes.
 Solder metric: ODF for 6mm tubes. Solder inch: ODF for ¼" tubes

Quick Selection Tables

Published capacity data at 1 K subcooling at the inlet of the expansion valve and 1.5 bar pressure drop in the refrigeration system. For proper valve selection especially in case of high pressure drops, we recommend the use of correction factors.

To facilitate valve dimensioning for other than the standard conditions, Emerson Climate Technologies offers Copeland Select (www.emersonclimate.eu).

Condensing Temperature °C	R134a		Capacity (kW) Valve Type TI ... - M... Evaporating Temperature (°C)											Cage Size	
	+30	+20	+10	+5	0	-5	-10	-15	-20	-25	-30				
+50	0.23	0.27	0.29	0.29	0.30	0.30	0.30	0.26	0.22	0.19	0.16				TIO-00X
	0.60	0.71	0.76	0.78	0.79	0.79	0.79	0.68	0.59	0.50	0.43				TIO-000
	1.42	1.68	1.81	1.85	1.87	1.88	1.87	1.63	1.39	1.20	1.01				TIO-001
	2.32	2.74	2.96	3.02	3.05	3.07	3.06	2.65	2.27	1.95	1.66				TIO-002
	3.74	4.42	4.77	7.87	4.92	4.94	4.93	4.28	3.66	3.15	2.67				TIO-003
	6.21	7.34	7.93	8.08	8.17	8.21	8.19	7.10	6.08	5.23	4.43				TIO-004
	7.56	8.93	9.64	9.84	9.95	9.99	9.97	8.64	7.40	6.36	5.39				TIO-005
8.76	10.34	11.17	11.40	11.52	11.57	11.55	10.01	8.57	7.37	6.25				TIO-006	
+40	0.12	0.21	0.25	0.26	0.27	0.28	0.28	0.25	0.21	0.18	0.16				TIO-00X
	0.33	0.56	0.67	0.67	0.73	0.74	0.75	0.66	0.57	0.49	0.42				TIO-000
	0.79	1.34	1.60	1.60	1.73	1.76	1.78	1.56	1.35	1.17	1.00				TIO-001
	1.29	2.18	2.60	2.73	2.82	2.88	2.91	2.55	2.20	1.91	1.63				TIO-002
	2.08	3.52	4.20	4.40	4.55	4.64	4.69	4.11	3.56	3.08	2.63				TIO-003
	3.45	5.84	6.97	7.31	7.55	7.70	7.79	6.83	5.90	5.12	4.37				TIO-004
	4.19	7.10	8.48	8.90	9.19	9.38	9.48	8.31	7.18	6.23	5.32				TIO-005
4.86	8.23	9.83	10.31	10.64	10.86	10.98	9.63	8.32	7.22	6.16				TIO-006	
+35	0.17	0.23	0.24	0.26	0.26	0.27	0.24	0.21	0.18	0.15					TIO-00X
	0.44	0.60	0.65	0.68	0.70	0.72	0.63	0.55	0.48	0.41					TIO-000
	1.06	1.43	1.54	1.61	1.67	1.70	1.50	1.31	1.14	0.98					TIO-001
	1.72	2.33	2.50	2.63	2.72	2.78	2.45	2.13	1.86	1.59					TIO-002
	2.78	3.75	4.04	4.24	4.39	4.48	3.95	3.44	3.00	2.57					TIO-003
	4.62	6.23	6.71	7.05	7.28	7.43	6.56	5.71	4.97	4.27					TIO-004
	5.62	7.58	8.16	8.57	8.86	9.05	7.99	6.95	6.05	5.19					TIO-005
6.51	8.79	9.45	9.93	10.26	10.48	9.25	8.05	7.01	6.01					TIO-006	
+30	0.09	0.19	0.21	0.23	0.24	0.25	0.23	0.20	0.17	0.15					TIO-00X
	0.25	0.51	0.57	0.62	0.65	0.67	0.60	0.52	0.46	0.40					TIO-000
	0.60	1.20	1.35	1.46	1.54	1.59	1.42	1.25	1.09	0.94					TIO-001
	0.98	1.96	2.21	2.39	2.51	2.60	2.32	2.03	1.78	1.54					TIO-002
	1.58	3.16	3.57	3.85	4.05	4.19	3.74	3.28	2.87	2.48					TIO-003
	2.63	5.25	5.92	6.39	6.73	6.96	6.21	5.44	4.77	4.11					TIO-004
	3.20	6.39	7.20	7.78	8.19	8.47	7.56	6.62	5.81	5.00					TIO-005
3.71	7.40	8.34	9.01	9.49	9.82	8.75	7.67	6.73	5.80					TIO-006	
+25	0.14	0.18	0.20	0.22	0.23	0.21	0.18	0.16	0.14						TIO-00X
	0.37	0.47	0.54	0.58	0.61	0.56	0.49	0.43	0.38						TIO-000
	0.89	1.12	1.27	1.38	1.46	1.32	1.17	1.03	0.90						TIO-001
	1.45	1.82	2.08	2.25	2.38	2.15	1.91	1.68	1.46						TIO-002
	2.33	2.94	3.35	3.64	3.84	3.47	3.07	2.72	2.36						TIO-003
	3.87	4.88	5.56	6.03	6.37	5.76	5.10	4.51	3.91						TIO-004
	4.71	5.94	6.76	7.34	7.75	7.01	6.21	5.49	4.76						TIO-005
5.45	6.88	7.84	8.51	8.98	8.12	7.19	6.36	5.52						TIO-006	
+20	0.02	0.12	0.16	0.19	0.20	0.19	0.17	0.15	0.13						TIO-00X
	0.04	0.33	0.43	0.50	0.54	0.50	0.45	0.40	0.35						TIO-000
	0.10	0.77	1.02	1.18	1.29	1.19	1.07	0.96	0.84						TIO-001
	0.17	1.26	1.66	1.92	2.10	1.94	1.75	1.56	1.37						TIO-002
	0.27	2.04	2.68	3.10	3.39	3.13	2.82	2.52	2.20						TIO-003
	0.44	3.38	4.45	5.14	5.62	5.20	4.68	4.18	3.66						TIO-004
	0.54	4.11	5.41	6.25	6.84	6.33	5.69	5.09	4.45						TIO-005
0.62	4.76	6.27	7.24	7.92	7.33	6.59	5.89	5.15						TIO-006	

Condensing Temperature °C	R404A		Capacity (kW) Valve Type TI ... - S.... Evaporating Temperature (°C)												Cage Size
	+30	+20	+10	+5	0	-5	-10	-15	-20	-25	-30	-35	-40	-45	
+50	0.27	0.32	0.34	0.35	0.35	0.35	0.34	0.30	0.25	0.22	0.18	0.15	0.13	0.10	TIO-00X
	0.71	0.82	0.88	0.89	0.89	0.89	0.88	0.77	0.65	0.56	0.47	0.39	0.33	0.27	TIO-000
	1.65	1.91	2.04	2.07	2.08	2.07	2.05	1.80	1.53	1.30	1.10	0.92	0.76	0.62	TIO-001
	50.00	2.82	3.28	3.50	3.55	3.57	3.55	3.52	3.08	2.62	2.24	1.88	1.58	1.30	TIO-002
	4.47	5.19	5.54	5.62	5.65	5.63	5.57	4.88	4.14	3.54	2.98	2.50	2.06	1.69	TIO-003
	7.29	8.47	9.05	9.17	9.21	9.18	9.09	7.96	6.76	5.78	4.86	4.07	3.37	2.76	TIO-004
	8.85	10.29	10.99	11.15	11.20	11.16	11.04	9.67	8.22	7.02	5.90	4.95	4.09	3.36	TIO-005
10.26	11.93	12.74	12.92	12.98	12.93	12.80	11.21	9.53	8.13	6.84	5.74	4.75	3.89	TIO-006	
+40	0.20	0.29	0.34	0.35	0.36	0.37	0.37	0.33	0.28	0.24	0.21	0.18	0.15	0.12	TIO-00X
	0.51	0.75	0.87	0.91	0.93	0.95	0.95	0.84	0.73	0.63	0.54	0.46	0.38	0.32	TIO-000
	1.19	1.75	2.04	2.12	2.18	2.21	2.22	1.97	1.70	1.47	1.25	1.06	0.89	0.74	TIO-001
	2.03	3.00	3.49	3.64	3.73	3.78	3.80	3.38	2.91	2.52	2.14	1.82	1.53	1.27	TIO-002
	3.22	4.76	5.53	5.76	5.91	5.99	6.02	5.35	4.61	3.99	3.39	2.88	2.42	2.01	TIO-003
	5.25	7.76	9.02	9.40	9.64	9.78	9.83	8.73	7.52	6.50	5.54	4.70	3.94	3.28	TIO-004
	6.38	9.43	10.96	11.42	11.71	11.88	11.94	10.61	9.14	7.90	6.73	5.71	4.79	3.98	TIO-005
7.40	10.93	12.71	13.23	13.58	13.77	13.84	12.30	10.59	9.16	7.80	6.62	5.55	4.62	TIO-006	
+35		0.25	0.32	0.34	0.36	0.37	0.37	0.33	0.29	0.25	0.21	0.18	0.15	0.13	TIO-00X
		0.65	0.83	0.88	0.92	0.94	0.95	0.85	0.74	0.64	0.55	0.47	0.40	0.33	TIO-000
		1.53	1.93	2.06	2.14	2.20	2.23	1.99	1.73	1.50	1.29	1.10	0.93	0.77	TIO-001
		2.62	3.32	3.52	3.67	3.76	3.82	3.42	2.96	2.58	2.21	1.88	1.59	1.33	TIO-002
		4.15	5.25	5.58	5.81	5.96	6.05	5.41	4.69	4.08	3.50	2.98	2.51	2.10	TIO-003
		6.77	8.56	9.10	9.48	9.72	9.86	8.83	7.65	6.66	5.70	4.87	4.10	3.43	TIO-004
		8.22	10.41	11.06	11.51	11.81	11.98	10.73	9.30	8.09	6.93	5.92	4.99	4.17	TIO-005
	9.53	12.06	12.82	13.35	13.69	13.89	12.44	10.78	9.38	8.03	6.86	5.78	4.83	TIO-006	
+30		0.19	0.29	0.32	0.34	0.36	0.36	0.33	0.29	0.25	0.22	0.19	0.16	0.13	TIO-00X
		0.49	0.75	0.83	0.88	0.91	0.94	0.85	0.74	0.65	0.56	0.48	0.41	0.34	TIO-000
		1.15	1.75	1.93	2.05	2.13	2.19	1.98	1.73	1.51	1.30	1.12	0.95	0.79	TIO-001
		1.97	3.01	3.30	3.51	3.66	3.75	3.39	2.96	2.59	2.23	1.92	1.62	1.36	TIO-002
		3.13	4.76	5.23	5.56	5.79	5.94	5.36	4.69	4.10	3.53	3.03	2.57	2.16	TIO-003
		5.10	7.77	8.53	9.07	9.44	9.69	8.75	7.65	6.70	5.77	4.95	4.19	3.52	TIO-004
		6.20	9.44	10.36	11.02	11.48	11.77	10.63	9.29	8.14	7.01	6.01	5.09	4.27	TIO-005
	7.18	10.94	12.01	12.77	13.30	13.65	12.33	10.77	9.43	8.12	6.97	5.90	4.95	TIO-006	
+25			0.25	0.29	0.32	0.34	0.35	0.32	0.28	0.25	0.22	0.19	0.16	0.13	TIO-00X
			0.63	0.74	0.81	0.86	0.90	0.82	0.73	0.64	0.55	0.48	0.41	0.34	TIO-000
			1.48	1.72	1.90	2.02	2.10	1.92	1.69	1.49	1.29	1.12	0.95	0.80	TIO-001
			2.53	2.95	3.25	3.46	3.60	3.29	2.90	2.56	2.22	1.91	1.63	1.37	TIO-002
			4.01	4.68	5.14	5.48	5.71	5.21	4.60	4.06	3.51	3.03	2.58	2.17	TIO-003
			6.54	7.63	8.39	8.94	9.31	8.51	7.50	6.62	5.73	4.95	4.21	3.55	TIO-004
			7.95	9.27	10.20	10.86	11.31	10.34	9.11	8.04	6.96	6.01	5.11	4.31	TIO-005
		9.22	10.75	11.82	12.59	13.11	11.98	10.56	9.32	8.07	6.97	5.93	5.00	TIO-006	
+20			0.17	0.24	0.28	0.31	0.33	0.30	0.27	0.24	0.21	0.18	0.16	0.13	TIO-00X
			0.44	0.61	0.72	0.79	0.84	0.78	0.70	0.62	0.54	0.47	0.40	0.34	TIO-000
			1.04	1.42	1.67	1.85	1.97	1.83	1.63	1.45	1.27	1.10	0.94	0.80	TIO-001
			1.78	2.44	2.87	3.16	3.37	3.13	2.79	2.49	2.17	1.88	1.61	1.36	TIO-002
			2.82	3.86	4.54	5.01	5.34	4.96	4.42	3.94	3.44	2.98	2.55	2.16	TIO-003
			4.59	6.30	7.41	8.17	8.71	8.09	7.21	6.42	5.61	4.87	4.16	3.53	TIO-004
			5.58	7.66	9.00	9.93	10.58	9.83	8.76	7.80	6.81	5.91	5.06	4.28	TIO-005
		6.47	8.88	10.43	11.51	12.27	11.39	10.16	9.05	7.90	6.86	5.86	4.97	TIO-006	

Condensing Temperature °C		R407C		Capacity (kW) Valve Type TI ... - N.... Evaporating Temperature (°C)							Cage Size
Dew Point	Bubble Point	+20	+10	+5	0	-5	-10	-15	-20	-25	
+54	+50	0.49	0.52	0.52	0.53	0.53	0.53	0.46	0.38	0.32	TIO-00X
		1.27	1.34	1.36	1.37	1.37	1.36	1.19	1.00	0.83	TIO-000
		3.17	3.35	3.39	3.42	3.42	3.41	2.99	2.49	2.07	TIO-001
		5.16	5.45	5.53	5.57	5.57	5.55	4.86	4.06	3.37	TIO-002
		8.33	8.80	8.92	8.98	9.00	8.96	7.85	6.55	5.44	TIO-003
		13.58	14.35	14.55	14.65	14.67	14.61	12.80	10.69	8.87	TIO-004
		16.57	17.50	17.75	17.87	17.89	17.82	15.61	13.04	10.82	TIO-005
		19.11	20.18	20.46	20.60	20.63	20.55	18.00	15.03	12.47	TIO-006
+45	+40	0.44	0.49	0.51	0.52	0.53	0.53	0.47	0.39	0.33	TIO-00X
		1.14	1.28	1.32	1.34	1.36	1.37	1.21	1.02	0.85	TIO-000
		2.86	3.19	3.29	3.36	3.40	3.42	3.02	2.54	2.13	TIO-001
		4.66	5.19	5.36	5.47	5.54	5.58	4.93	4.14	3.46	TIO-002
		7.52	8.38	8.65	8.83	8.95	9.00	7.95	6.69	5.59	TIO-003
		12.25	13.66	14.10	14.40	14.58	14.67	12.96	10.91	9.11	TIO-004
		14.95	16.67	17.20	17.57	17.79	17.90	15.82	13.31	11.12	TIO-005
		17.24	19.22	19.83	20.25	20.52	20.64	18.24	15.34	12.82	TIO-006
+40	+35	0.40	0.47	0.49	0.50	0.51	0.52	0.46	0.39	0.33	TIO-00X
		1.03	1.21	1.26	1.30	1.33	1.34	1.19	1.01	0.85	TIO-000
		2.58	3.02	3.15	3.25	3.32	3.36	2.99	2.52	2.12	TIO-001
		4.20	4.91	5.14	5.30	5.41	5.47	4.86	4.11	3.45	TIO-002
		6.78	7.93	8.29	8.55	8.73	8.84	7.85	6.63	5.56	TIO-003
		11.06	12.93	13.52	13.94	14.23	14.41	12.79	10.81	9.07	TIO-004
		13.49	15.77	16.49	17.01	17.36	17.58	15.61	13.19	11.06	TIO-005
		15.56	18.19	19.02	19.61	20.02	20.27	18.00	15.21	12.75	TIO-006
+35	+30	0.34	0.43	0.46	0.48	0.49	0.50	0.45	0.38	0.32	TIO-00X
		0.88	1.11	1.18	1.24	1.28	1.30	1.16	0.99	0.83	TIO-000
		2.19	2.78	2.96	3.09	3.19	3.25	2.91	2.47	2.08	TIO-001
		3.57	4.53	4.82	5.04	5.20	5.30	4.74	4.02	3.39	TIO-002
		5.76	7.30	7.78	8.13	8.39	8.56	7.64	6.49	5.47	TIO-003
		9.39	11.91	12.69	13.26	13.67	13.95	12.46	10.58	8.92	TIO-004
		11.46	14.53	15.48	16.18	16.68	17.02	15.21	12.91	10.88	TIO-005
		13.22	16.75	17.85	18.66	19.23	19.62	17.53	14.89	12.54	TIO-006
+30	+25		0.38	0.42	0.44	0.46	0.48	0.43	0.37	0.31	TIO-00X
			0.98	1.08	1.15	1.21	1.24	1.12	0.96	0.81	TIO-000
			2.46	2.70	2.88	3.01	3.11	2.80	2.39	2.02	TIO-001
			4.01	4.40	4.70	4.91	5.06	4.55	3.89	3.29	TIO-002
			6.47	7.11	7.58	7.92	8.16	7.35	6.28	5.32	TIO-003
			10.55	11.59	12.36	12.91	13.31	11.98	10.24	8.67	TIO-004
			12.87	14.14	15.07	15.75	16.24	14.62	12.49	10.58	TIO-005
	14.84	16.31	17.38	18.17	18.72	16.86	14.40	12.19	TIO-006		
+26	+20			0.37	0.40	0.43	0.45	0.41	0.35	0.30	TIO-00X
				0.95	1.04	1.11	1.16	1.06	0.91	0.78	TIO-000
				2.37	2.61	2.78	2.91	2.65	2.28	1.94	TIO-001
				3.86	4.25	4.54	4.74	4.31	3.71	3.16	TIO-002
				6.23	6.86	7.32	7.65	6.96	6.00	5.11	TIO-003
				10.16	11.19	11.93	12.47	11.35	9.77	8.33	TIO-004
				12.40	13.65	14.56	15.22	13.85	11.92	10.16	TIO-005
		14.30	15.74	16.79	17.55	15.97	13.75	11.71	TIO-006		

Condensing Temperature °C	R410A		Capacity (kW) Valve Type TI ... - Z.... Evaporating Temperature (°C)											Cage Size
	+15	+10	+5	0	-5	-10	-15	-20	-25	-30	-35	-40	-45	
+50	0.53	0.55	0.57	0.58	0.59	0.60	0.53	0.47	0.40	0.33	0.28	0.23	0.20	TIO-00X
	1.38	1.44	1.49	1.52	1.54	1.56	1.39	1.21	1.03	0.87	0.73	0.61	0.51	TIO-000
	3.40	3.55	3.66	3.74	3.80	3.84	3.41	2.98	2.54	2.14	1.79	1.49	1.25	TIO-001
	5.64	5.87	6.06	6.20	6.29	6.36	5.65	4.94	4.21	3.54	2.96	2.48	2.08	TIO-002
	9.04	9.42	9.72	9.94	10.09	10.20	9.06	7.92	6.75	5.68	4.75	3.97	3.33	TIO-003
	14.79	15.41	15.89	16.25	16.51	16.67	14.82	12.94	11.03	9.28	7.76	6.49	5.44	TIO-004
	17.98	18.73	19.32	19.76	20.07	20.27	18.02	15.74	13.42	11.28	9.44	7.89	6.62	TIO-005
	20.75	21.61	22.29	22.79	23.16	23.39	20.79	18.16	15.48	13.02	10.89	9.11	7.63	TIO-006
+40	0.49	0.53	0.55	0.58	0.59	0.61	0.54	0.48	0.41	0.35	0.29	0.25	0.21	TIO-00X
	1.28	1.37	1.44	1.50	1.54	1.58	1.41	1.24	1.07	0.90	0.76	0.64	0.54	TIO-000
	3.14	3.37	3.55	3.69	3.80	3.88	3.48	3.06	2.63	2.22	1.87	1.57	1.32	TIO-001
	5.20	5.58	5.88	6.11	6.29	6.42	5.76	5.07	4.35	3.68	3.10	2.60	2.19	TIO-002
	8.35	8.95	9.43	9.81	10.09	10.30	9.24	8.13	6.98	5.91	4.97	4.18	3.52	TIO-003
	13.65	14.64	15.42	16.04	16.50	16.85	15.11	13.30	11.41	9.66	8.13	6.83	5.76	TIO-004
	16.60	17.80	18.75	19.50	20.06	20.48	18.37	16.17	13.88	11.75	9.88	8.31	7.00	TIO-005
	19.15	20.54	21.64	22.50	23.15	23.64	21.20	18.66	16.01	13.55	11.40	9.58	8.07	TIO-006
+35	0.45	0.49	0.53	0.56	0.58	0.60	0.54	0.47	0.41	0.35	0.29	0.25	0.21	TIO-00X
	1.17	1.28	1.38	1.45	1.51	1.55	1.40	1.23	1.06	0.90	0.76	0.64	0.54	TIO-000
	2.87	3.16	3.39	3.57	3.70	3.81	3.44	3.04	2.62	2.22	1.88	1.58	1.34	TIO-001
	4.75	5.23	5.61	5.91	6.14	6.31	5.69	5.03	4.34	3.68	3.11	2.62	2.21	TIO-002
	7.62	8.39	9.00	9.47	9.84	10.12	9.13	8.07	6.96	5.91	4.99	4.20	3.55	TIO-003
	12.46	13.73	14.72	15.49	16.09	16.55	14.93	13.20	11.38	9.66	8.15	6.87	5.80	TIO-004
	15.15	16.69	17.89	18.84	19.57	20.12	18.15	16.05	13.83	11.75	9.91	8.35	7.05	TIO-005
	17.48	19.26	20.65	21.73	22.58	23.22	20.94	18.52	15.96	13.55	11.44	9.64	8.14	TIO-006
+30	0.39	0.45	0.49	0.53	0.55	0.58	0.52	0.47	0.40	0.34	0.29	0.25	0.21	TIO-00X
	1.00	1.16	1.28	1.37	1.44	1.50	1.36	1.21	1.05	0.89	0.76	0.64	0.54	TIO-000
	2.47	2.86	3.15	3.37	3.55	3.69	3.35	2.98	2.58	2.20	1.86	1.57	1.33	TIO-001
	4.10	4.73	5.21	5.59	5.88	6.10	5.55	4.93	4.27	3.64	3.08	2.61	2.21	TIO-002
	6.57	7.59	8.36	8.96	9.43	9.79	8.89	7.91	6.85	5.84	4.94	4.18	3.54	TIO-003
	10.74	12.41	13.67	14.66	15.42	16.01	14.54	12.94	11.20	9.55	8.09	6.83	5.79	TIO-004
	13.06	15.09	16.63	17.82	18.75	19.46	17.68	15.73	13.62	11.61	9.83	8.31	7.04	TIO-005
	15.07	17.41	19.18	20.56	21.63	22.46	20.40	18.15	15.71	13.40	11.34	9.59	8.12	TIO-006
+25	0.30	0.38	0.44	0.49	0.52	0.55	0.50	0.45	0.39	0.34	0.29	0.24	0.21	TIO-00X
	0.77	0.99	1.15	1.26	1.35	1.42	1.31	1.17	1.02	0.87	0.74	0.63	0.53	TIO-000
	1.89	2.43	2.82	3.11	3.33	3.50	3.21	2.88	2.51	2.15	1.83	1.55	1.32	TIO-001
	3.13	4.03	4.67	5.15	5.52	5.80	5.32	4.77	4.16	3.56	3.03	2.57	2.18	TIO-002
	5.03	6.46	7.49	8.26	8.85	9.31	8.54	7.65	6.66	5.71	4.85	4.11	3.49	TIO-003
	8.22	10.57	12.24	13.50	14.47	15.22	13.97	12.51	10.90	9.34	7.93	6.73	5.71	TIO-004
	10.00	12.85	14.89	16.42	17.60	18.51	16.98	15.22	13.25	11.35	9.65	8.18	6.95	TIO-005
	11.53	14.83	17.18	18.95	20.31	21.36	19.59	17.56	15.29	13.10	11.13	9.44	8.01	TIO-006
+20	0.13	0.28	0.37	0.43	0.48	0.51	0.47	0.43	0.38	0.32	0.28	0.24	0.20	TIO-00X
	0.33	0.74	0.96	1.12	1.24	1.33	1.23	1.12	0.98	0.84	0.72	0.61	0.52	TIO-000
	0.82	1.82	2.37	2.76	3.04	3.26	3.04	2.75	2.41	2.08	1.77	1.51	1.29	TIO-001
	1.35	3.02	3.93	4.57	5.04	5.41	5.03	4.55	3.99	3.44	2.94	2.50	2.13	TIO-002
	2.17	4.84	6.30	7.32	8.09	8.67	8.06	7.30	6.40	5.52	4.71	4.01	3.42	TIO-003
	3.55	7.91	10.30	11.98	13.23	14.18	13.18	11.93	10.47	9.02	7.70	6.56	5.59	TIO-004
	4.32	9.62	12.52	14.56	16.08	17.24	16.03	14.51	12.73	10.97	9.36	7.97	6.79	TIO-005
	4.98	11.10	14.45	16.80	18.55	19.89	18.50	16.74	14.68	12.65	10.81	9.20	7.84	TIO-006

Condensing Temperature °C	R507		Capacity (kW) Valve Type TI ... - S.... Evaporating Temperature (°C)												Cage Size
	+30	+20	+10	+5	+0	-5	-10	-15	-20	-25	-30	-35	-40	-45	
+50	0.29	0.34	0.36	0.37	0.37	0.37	0.37	0.32	0.27	0.23	0.19	0.16	0.13	0.11	TIO-00X
	0.73	0.85	0.91	0.92	0.93	0.93	0.92	0.80	0.68	0.58	0.49	0.40	0.33	0.26	TIO-000
	1.68	1.95	2.09	2.12	2.13	2.13	2.11	1.83	1.57	1.33	1.12	0.92	0.76	0.61	TIO-001
	2.85	3.31	3.54	3.59	3.62	3.61	3.58	3.10	2.66	2.26	1.89	1.57	1.28	1.03	TIO-002
	4.54	5.26	5.63	5.71	5.75	5.74	5.69	4.93	4.23	3.59	3.01	2.49	2.04	1.64	TIO-003
	7.39	8.57	9.17	9.31	9.36	9.35	9.28	8.04	6.88	5.85	4.90	4.06	3.32	2.67	TIO-004
	9.00	10.44	11.16	11.33	11.40	11.39	11.30	9.79	8.38	7.12	5.97	4.94	4.04	3.26	TIO-005
	10.39	12.05	12.89	13.08	13.16	13.15	13.04	11.31	9.68	8.22	6.89	5.70	4.66	3.76	TIO-006
+40	0.21	0.31	0.36	0.37	0.38	0.39	0.39	0.34	0.30	0.26	0.22	0.18	0.15	0.12	TIO-00X
	0.52	0.77	0.89	0.93	0.96	0.97	0.98	0.86	0.75	0.64	0.54	0.46	0.38	0.31	TIO-000
	1.20	1.77	2.05	2.14	2.20	2.23	2.25	1.98	1.71	1.47	1.25	1.05	0.87	0.71	TIO-001
	2.04	3.00	3.48	3.63	3.73	3.79	3.82	3.35	2.91	2.50	2.12	1.78	1.47	1.20	TIO-002
	3.24	4.76	5.54	5.77	5.93	6.02	6.07	5.33	4.62	3.97	3.37	2.82	2.34	1.91	TIO-003
	5.28	7.76	9.02	9.40	9.66	9.81	9.88	8.68	7.53	6.47	5.49	4.60	3.80	3.10	TIO-004
	6.43	9.45	10.99	11.45	11.76	11.95	12.04	10.57	9.17	7.88	6.68	5.60	4.63	3.78	TIO-005
	7.42	10.91	12.68	13.22	13.58	13.79	13.90	12.20	10.59	9.10	7.72	6.46	5.35	4.36	TIO-006
+35	0.27	0.34	0.36	0.37	0.38	0.39	0.35	0.30	0.26	0.22	0.19	0.16	0.13	TIO-00X	
	0.67	0.84	0.90	0.94	0.96	0.98	0.86	0.75	0.65	0.56	0.47	0.39	0.32	TIO-000	
	1.53	1.94	2.06	2.15	2.21	2.25	1.99	1.74	1.50	1.28	1.08	0.90	0.73	TIO-001	
	2.60	3.29	3.50	3.65	3.75	3.81	3.37	2.94	2.55	2.17	1.83	1.52	1.25	TIO-002	
	4.14	5.23	5.56	5.80	5.96	6.06	5.36	4.68	4.05	3.45	2.90	2.41	1.98	TIO-003	
	6.74	8.52	9.06	9.45	9.71	9.87	8.73	7.62	6.59	5.62	4.73	3.93	3.23	TIO-004	
	8.21	10.38	11.04	11.50	11.82	12.02	10.63	9.28	8.03	6.84	5.76	4.79	3.93	TIO-005	
	9.47	11.98	12.74	13.28	13.65	13.87	12.27	10.72	9.27	7.90	6.65	5.53	4.54	TIO-006	
+30	0.20	0.31	0.34	0.36	0.37	0.38	0.34	0.30	0.26	0.22	0.19	0.16	0.13	TIO-00X	
	0.50	0.76	0.84	0.89	0.93	0.96	0.85	0.75	0.65	0.56	0.47	0.40	0.33	TIO-000	
	1.16	1.75	1.93	2.05	2.14	2.20	1.96	1.73	1.50	1.29	1.09	0.91	0.75	TIO-001	
	1.96	2.98	3.27	3.48	3.63	3.73	3.33	2.93	2.55	2.19	1.85	1.54	1.27	TIO-002	
	3.12	4.73	5.19	5.53	5.77	5.93	5.29	4.66	4.05	3.47	2.94	2.45	2.02	TIO-003	
	5.08	7.71	8.46	9.01	9.40	9.66	8.62	7.59	6.60	5.66	4.79	4.00	3.29	TIO-004	
	6.18	9.38	10.30	10.97	11.44	11.76	10.50	9.24	8.04	6.89	5.83	4.87	4.01	TIO-005	
	7.14	10.83	11.90	12.66	13.21	13.58	12.12	10.67	9.28	7.96	6.73	5.62	4.63	TIO-006	
+25	0.26	0.30	0.33	0.35	0.37	0.33	0.29	0.26	0.22	0.19	0.16	0.13	TIO-00X		
	0.64	0.75	0.82	0.88	0.92	0.83	0.73	0.64	0.56	0.47	0.40	0.33	TIO-000		
	1.48	1.72	1.90	2.02	2.11	1.90	1.69	1.48	1.28	1.09	0.91	0.75	TIO-001		
	2.50	2.92	3.21	3.43	3.58	3.23	2.87	2.51	2.17	1.84	1.55	1.28	TIO-002		
	3.98	4.64	5.11	5.45	5.68	5.13	4.56	3.99	3.45	2.93	2.46	2.03	TIO-003		
	6.48	7.56	8.32	8.87	9.26	8.36	7.42	6.51	5.61	4.77	4.01	3.32	TIO-004		
	7.89	9.20	10.13	10.80	11.28	10.18	9.04	7.92	6.84	5.82	4.88	4.04	TIO-005		
	9.11	10.63	11.70	12.47	13.02	11.76	10.44	9.15	7.89	6.71	5.63	4.66	TIO-006		
+20	0.18	0.25	0.29	0.32	0.34	0.31	0.28	0.25	0.22	0.19	0.16	0.13	TIO-00X		
	0.45	0.62	0.73	0.80	0.86	0.79	0.71	0.63	0.54	0.46	0.39	0.33	TIO-000		
	1.04	1.42	1.67	1.85	1.97	1.81	1.63	1.44	1.25	1.07	0.90	0.75	TIO-001		
	1.76	2.41	2.84	3.13	3.34	3.07	2.76	2.44	2.12	1.81	1.53	1.27	TIO-002		
	2.80	3.84	4.51	4.98	5.32	4.88	4.38	3.88	3.37	2.88	2.43	2.02	TIO-003		
	4.57	6.25	7.34	8.11	8.66	7.95	7.14	6.31	5.49	4.70	3.96	3.29	TIO-004		
	5.56	7.61	8.94	9.88	10.55	9.68	8.69	7.69	6.68	5.72	4.82	4.01	TIO-005		
	6.42	8.78	10.32	11.40	12.18	11.17	10.04	8.88	7.71	6.60	5.57	4.63	TIO-006		

Condensing Temperature °C	R22		Capacity (kW) Valve Type TI... - H... Evaporating Temperature (°C)												Cage Size	
	+30	+20	+10	+5	0	-5	-10	-15	-20	-25	-30	-35	-40	-45		
+50		0.38	0.45	0.50	0.51	0.52	0.53	0.53	0.46	0.41	0.35	0.30	0.26	0.22	0.19	TIO-00X
		0.98	1.17	1.29	1.33	1.35	1.38	1.36	1.20	1.05	0.91	0.78	0.66	0.57	0.48	TIO-000
		2.40	2.86	3.16	3.26	3.32	3.39	3.33	2.95	2.58	2.24	1.91	1.62	1.40	1.19	TIO-001
		4.03	4.78	5.29	4.47	5.56	5.67	5.57	4.95	4.32	3.75	3.20	2.72	2.35	2.00	TIO-002
		6.41	7.64	8.42	8.70	8.85	9.03	8.87	7.88	6.87	5.97	5.10	4.34	3.45	3.18	TIO-003
		10.50	12.51	13.79	14.26	14.50	14.80	14.53	12.90	11.26	9.79	8.35	7.10	6.14	5.21	TIO-004
		12.80	15.24	16.81	17.37	17.67	18.03	17.70	15.72	13.72	11.93	10.18	8.66	7.49	6.35	TIO-005
		14.76	17.58	19.38	20.04	20.38	20.79	20.42	18.14	15.82	13.76	11.74	9.98	8.64	7.32	TIO-006
+40		0.24	0.37	0.44	0.46	0.48	0.50	0.49	0.44	0.39	0.34	0.29	0.25	0.22	0.18	TIO-00X
		0.61	0.95	1.14	1.20	1.25	1.29	1.27	1.15	1.01	0.88	0.75	0.64	0.56	0.47	TIO-000
		1.51	2.33	2.78	2.94	3.07	3.17	3.12	2.82	2.47	2.16	1.85	1.58	1.38	1.17	TIO-001
		2.52	3.90	4.66	4.92	5.13	5.30	5.23	4.73	4.14	3.62	3.10	2.65	2.31	1.96	TIO-002
		4.02	6.21	7.42	7.84	8.18	8.44	8.33	7.53	6.59	5.76	4.94	4.23	3.68	3.12	TIO-003
		6.59	10.17	12.16	12.85	13.39	13.83	13.65	12.33	10.79	9.44	8.10	6.92	6.03	5.12	TIO-004
		8.03	12.40	14.82	15.65	16.32	16.85	16.63	15.03	13.15	11.50	9.87	8.44	7.35	6.23	TIO-005
		9.26	14.30	17.09	18.05	18.82	19.43	19.18	17.33	15.17	13.26	11.38	9.73	8.48	7.19	TIO-006
+35			0.30	0.40	0.43	0.45	0.47	0.48	0.43	0.38	0.33	0.29	0.24	0.21	0.18	TIO-00X
			0.79	1.03	1.11	1.17	1.22	1.23	1.11	0.98	0.85	0.74	0.63	0.55	0.47	TIO-000
			1.93	2.53	2.72	2.88	3.00	3.01	2.71	2.40	2.09	1.81	1.55	1.35	1.15	TIO-001
			3.24	4.23	4.56	4.82	5.02	5.03	4.54	4.02	3.50	3.03	2.60	2.27	1.93	TIO-002
			5.16	6.74	7.27	7.68	8.00	8.01	7.23	6.40	5.57	4.83	4.14	3.61	3.07	TIO-003
			8.45	11.04	11.90	12.58	13.11	13.13	11.85	10.49	9.13	7.92	6.78	5.92	5.03	TIO-004
			10.30	13.46	14.50	15.32	15.97	16.00	14.44	12.78	11.12	9.65	8.27	7.21	6.13	TIO-005
			11.87	15.52	16.73	17.67	18.42	18.45	16.65	14.74	12.83	11.13	9.53	8.32	7.07	TIO-006
+30			0.21	0.34	0.38	0.41	0.44	0.44	0.41	0.36	0.31	0.27	0.24	0.21	0.18	TIO-00X
			0.55	0.89	0.99	1.07	1.13	1.15	1.05	0.93	0.81	0.70	0.61	0.53	0.46	TIO-000
			1.35	2.19	2.44	2.63	2.78	2.81	2.57	2.29	1.99	1.72	1.50	1.31	1.12	TIO-001
			2.26	3.67	4.09	4.41	4.66	4.71	4.30	3.83	3.33	2.88	2.52	2.20	1.88	TIO-002
			3.59	5.84	6.51	7.02	7.42	7.50	6.84	6.10	5.30	4.59	4.01	3.51	2.99	TIO-003
			5.89	9.56	10.66	11.50	12.16	12.28	11.21	10.00	8.68	7.51	6.57	5.75	4.90	TIO-004
			7.18	11.65	12.99	14.02	14.81	14.97	13.66	12.18	10.58	9.16	8.01	7.01	5.98	TIO-005
			8.28	13.44	14.98	16.16	17.08	17.26	15.76	14.05	12.20	10.56	9.24	8.08	6.89	TIO-006
+25			0.28	0.33	0.38	0.40	0.41	0.38	0.34	0.30	0.26	0.23	0.20	0.17	TIO-00X	
			0.71	0.85	0.97	1.04	1.07	0.98	0.88	0.78	0.68	0.59	0.51	0.44	TIO-000	
			1.76	2.10	2.37	2.56	2.62	2.40	2.16	1.91	1.67	1.44	1.26	1.08	TIO-001	
			2.94	3.51	3.97	4.29	4.39	4.03	3.62	3.21	2.79	2.42	2.12	1.81	TIO-002	
			4.68	5.59	6.33	6.84	7.00	6.41	5.77	5.11	4.45	3.85	3.37	2.88	TIO-003	
			7.67	9.16	10.36	11.20	11.46	10.50	9.46	8.37	7.29	6.31	5.52	4.72	TIO-004	
			9.35	11.16	12.63	13.64	13.96	12.80	11.52	10.19	8.89	7.69	6.73	5.75	TIO-005	
			10.79	12.88	14.57	15.74	16.11	14.76	13.29	11.76	10.25	8.87	7.76	6.64	TIO-006	
+20			0.18	0.26	0.31	0.35	0.38	0.35	0.32	0.28	0.25	0.22	0.19	0.16	TIO-00X	
			0.45	0.67	0.81	0.91	0.97	0.91	0.83	0.73	0.64	0.56	0.49	0.42	TIO-000	
			1.12	1.65	2.00	2.24	2.38	2.22	2.03	1.79	1.58	1.37	1.21	1.04	TIO-001	
			1.87	2.77	3.34	3.76	3.98	3.72	3.39	3.00	2.65	2.30	2.02	1.74	TIO-002	
			2.98	4.41	5.33	5.99	6.34	5.92	5.40	4.78	4.22	3.66	3.22	2.77	TIO-003	
			4.88	7.22	8.72	9.80	10.38	9.70	8.85	7.84	6.91	6.00	5.28	4.54	TIO-004	
			5.95	8.80	10.63	11.95	12.65	11.83	10.79	9.55	8.42	7.31	6.44	5.53	TIO-005	
			6.86	10.15	12.26	13.78	14.59	13.64	12.44	11.02	9.72	8.43	7.42	6.38	TIO-006	

Thermo™ -Expansion Valve Series TX3

For OEM use, hermetic design

Features

- Hermetic design with solder connections
- Internal or external equalizer
- External superheat adjustment
- Large diaphragm eliminates disturbances to the valve and provides smoother valve control
- Very compact size
- Version with internal check valve eliminates external check valve for heat pump applications
- Capillary tube length 1.5m
- PS: 45bar. TS: -45 ... +120°C
- Packaging units with 24 pieces, no single packs



MOP

MOP (bar)	Upper limit of Evaporating Temperature Range			
	R134a	R22	R407C	R410A
2.3				
3.3	+11°C			
6.4		+13°C	+14.5°C	
12.9				+17°C

Pressures are given in gauge pressure.

Selection Charts

R134a

Nominal Capacity	less MOP		with Standard-MOP		Equalizer	Inlet x Outlet Solder/ODF
	Type	Part No.	Type	Part No.		
1.8	TX3-M02	801766M	TX3-M12	801778M	Internal	¼" x ⅜"
2.8	TX3-M03	801767M			Internal	¼" x ⅜"
4.0	TX3-M04	801768M			Internal	⅜" x ½"
2.8	TX3-M23	801770M	TX3-M33	801782M	Ext. 1/4"	¼" x ⅜"
4.0	TX3-M24	801771M	TX3-M34	801783M	Ext. 1/4"	⅜" x ½"
6.1	TX3-M25	801772M	TX3-M35	801784M	Ext. 1/4"	⅜" x ½"
8.3	TX3-M26	801773M	TX3-M36	801785M	Ext. 1/4"	⅜" x ½"
10.2	TX3-M27	801774M	TX3-M37	801786M	Ext. 1/4"	½" x ⅝"
12.1	TX3-M28	801775M	TX3-M38	801787M	Ext. 1/4"	½" x ⅝"
16.5	TX3-M29	801776M	TX3-M39	801788M	Ext. 1/4"	½" x ⅝"

R22

Nominal Capacity	less MOP		with Standard-MOP		Equalizer	Inlet x Outlet Solder/ODF
	Type	Part No.	Type	Part No.		
5.2	TX3-H24	801741M	TX3-H34	801750M	Ext. 1/4"	⅜" x ½"
7.8	TX3-H25	801742M	TX3-H35	801751M	Ext. 1/4"	⅜" x ½"
10.7	TX3-H26	801743M			Ext. 1/4"	⅜" x ½"
15.6	TX3-H28	801745M			Ext. 1/4"	½" x ⅝"
21.3	TX3-H29	801746M	TX3-H39	801755M	Ext. 1/4"	½" x ⅝"

R410A

Nominal Capacity	less MOP		with Standard-MOP		Equalizer	Inlet x Outlet Solder/ODF
	Type	Part No.	Type	Part No.		
6.3			TX3-Z34	801944M	Ext. ¼"	¾" x ½"
9.4			TX3-Z35	801945M	Ext. ¼"	¾" x ½"
12.9			TX3-Z36	801946M	Ext. ¼"	¾" x ½"
15.8			TX3-Z37	801947M	Ext. ¼"	½" x ⅝"
18.8			TX3-Z38	801948M	Ext. ¼"	½" x ⅝"

R407C

Nominal Capacity	less MOP		with Standard-MOP		Equalizer	Inlet x Outlet Solder/ODF
	Type	Part No.	Type	Part No.		
0.9	TX3-N01	801813M			Internal	¼" x ⅜"
3.9			TX3-N13	801828M	Internal	¼" x ⅜"
2.5	TX3-N22	801818M			Ext. ¼"	¼" x ⅜"
3.9	TX3-N23	801819M	TX3-N33	801832M	Ext. ¼"	¼" x ⅜"
5.6	TX3-N24	801820M	TX3-N34	801833M	Ext. ¼"	¾" x ½"
8.4	TX3-N25	801821M	TX3-N35	801834M	Ext. ¼"	¾" x ½"
11.6	TX3-N26	801822M	TX3-N36	801835M	Ext. ¼"	¾" x ½"
14.2	TX3-N27	801823M	TX3-N37	801836M	Ext. ¼"	½" x ⅝"
16.9	TX3-N28	801824M	TX3-N38	801837M	Ext. ¼"	½" x ⅝"
23.0			TX3-N39	801838M	Ext. ¼"	½" x ⅝"

R407C for heat pump applications

Nominal Capacity	less MOP		Adjustable with internal check valve and special liquid charge for heat pump applications	Equalizer	Inlet x Outlet Solder/ODF
	Type	Part No.			
3.9	TX3-N63	806801M		Ext. ¼"	¼" x ⅜"
8.4	TX3-N65	806803M		Ext. ¼"	¾" x ½"
11.6	TX3-N66	806804M		Ext. ¼"	¾" x ½"
14.2	TX3-N67	806805M		Ext. ¼"	½" x ⅝"
16.9	TX3-N68	806806M		Ext. ¼"	½" x ⅝"
23.0	TX3-N69	806807M		Ext. ¼"	½" x ⅝"

Nominal capacity (Qn) is based on the following conditions:

Refrigerant	Evaporating temperature	Condensing temperature	Subcooling
R407C	+4°C dew point	+38°C bubble p. +43°C dew point	1K
others	+4°C	+38°C	1K

Valve selection for other operating conditions see "Correction Tables for Thermo-Expansion Valves Series TI, TX3, TX6, T and L" or use Copeland Select (download from www.emersonclimate.eu).

Thermo™-Expansion Valve Series TX6

Hermetic design

Features

- Balanced port design for constant superheat operation over a wide application range under variation of condensing pressure
- Hermetic monobloc design with solder connections for minimal leakage
- Large diaphragm eliminates disturbances to the valve and provides smoother and consistent valve control
- Tailored charges for different applications
- External equalizer
- External superheat adjustment
- PS: TX6-H/N/M/Sxx : 31bar. TX6-Zxx: 42bar
- TS: -45 ... +65°C
- No CE marking according art. 3.3 PED 97/23 EC



Standard MOP

Refrigerant	MOP			Evaporating temperature range
	Code	(bar)	°C	
R134a	M1	3.8	+14	-45 ... +10°C
R22	H1	6.9	+15	-45 ... +12°C
R407C	N1	6.9	+17	-45 ... +14°C
R410A	Z1	12.1	+16	-45 ... +15°C

Note: All temperatures are saturated/dew point. Pressures are given in gauge pressure.

Selection Charts

R134a

Nominal Capacity Q _n kW	less MOP		with Standard-MOP		Connection straight through Solder/ODF
	Type	Part No.	Type	Part No.	
10.3	TX6 - M02	801 543	TX6 - M12	801 547	12 mm x 16 mm
10.3	TX6 - M02	801 541	TX6 - M12	801 545	½" x ⅝"
18.4	TX6 - M03	801 544	TX6 - M13	801 548	12 mm x 16 mm
18.4	TX6 - M03	801 542	TX6 - M13	801 546	½" x ⅝"
25.6	TX6 - M04	801 569	TX6 - M14	801 577	16 mm x 22 mm
25.6	TX6 - M04	801 565	TX6 - M14	801 573	⅝" x ⅞"
32.5	TX6 - M05	801 570	TX6 - M15	801 578	16 mm x 22 mm
32.5	TX6 - M05	801 566	TX6 - M15	801 574	⅝" x ⅞"
48.1	TX6 - M06	801 571	TX6 - M16	801 579	22 mm x 28 mm
48.1	TX6 - M06	801 567	TX6 - M16	801 575	⅞" x 1-⅛"
62.8	TX6 - M07	801 572	TX6 - M17	801 580	22 mm x 28 mm
62.8	TX6 - M07	801 568	TX6 - M17	801 576	⅞" x 1-⅛"

Nominal capacity (Q_n) is based on the following conditions:

Refrigerant	Evaporating temperature	Condensing temperature	Subcooling
R407C	+4°C dew point	+38°C bubble p. +43°C dew point	1K
R22, R134a, R410A	+4°C	+38°C	1K

Valve selection for other operating conditions see "Correction Tables for Thermo-Expansion Valves Series TI, TX3, TX6, T and L" or use Copeland Select (download from www.emersonclimate.eu).

R407C

Nominal Capacity Q KW	less MOP		with Standard-MOP		Connection straight through Solder/ ODF
	Type	Part No.	Type	Part No.	
14.4	TX6 - N02	801 651	TX6 - N12	801 655	12 mm x 16 mm
14.4	TX6 - N02	801 653	TX6 - N12	801 534	½" x ⅝"
25.6	TX6 - N03	801 652	TX6 - N13	801 656	12 mm x 16 mm
25.6	TX6 - N03	801 654	TX6 - N13	801 535	½" x ⅝"
35.7	TX6 - N04	801 659	TX6 - N14	801 667	16 mm x 22 mm
35.7	TX6 - N04	801 663	TX6 - N14	801 536	⅝" x ⅞"
45.2	TX6 - N05	801 660	TX6 - N15	801 668	16 mm x 22 mm
45.2	TX6 - N05	801 664	TX6 - N15	801 537	⅝" x ⅞"
66.9	TX6 - N06	801 661	TX6 - N16	801 669	22 mm x 28 mm
66.9	TX6 - N06	801 665	TX6 - N16	801 538	⅞" x 1-⅛"
87.3	TX6 - N07	801 662	TX6 - N17	801 670	22 mm x 28 mm
87.3	TX6 - N07	801 666	TX6 - N17	801 539	⅞" x 1-⅛"

R22

Nominal Capacity Q KW	less MOP		with Standard-MOP		Connection straight through Solder/ ODF
	Type	Part No.	Type	Part No.	
13.3	TX6 - H02	801 551	TX6 - H12	801 555	12 mm x 16 mm
13.3	TX6 - H02	801 549	TX6 - H12	801 553	½" x ⅝"
23.7	TX6 - H03	801 552	TX6 - H13	801 556	12 mm x 16 mm
23.7	TX6 - H03	801 550	TX6 - H13	801 554	½" x ⅝"
33.0	TX6 - H04	801 585	TX6 - H14	801 593	16 mm x 22 mm
33.0	TX6 - H04	801 581	TX6 - H14	801 589	⅝" x ⅞"
41.8	TX6 - H05	801 586	TX6 - H15	801 594	16 mm x 22 mm
41.8	TX6 - H05	801 582	TX6 - H15	801 590	⅝" x ⅞"
61.9	TX6 - H06	801 587	TX6 - H16	801 595	22 mm x 28 mm
61.9	TX6 - H06	801 583	TX6 - H16	801 591	⅞" x 1-⅛"
80.8	TX6 - H07	801 588	TX6 - H17	801 596	22 mm x 28 mm
80.8	TX6 - H07	801 584	TX6 - H17	801 592	⅞" x 1-⅛"

R410A

Nominal Capacity Q KW	less MOP		with Standard-MOP		Connection straight through Solder/ ODF
	Type	Part No.	Type	Part No.	
16.0	-	-	TX6 - Z12	801 510	12 mm x 16 mm
16.0	-	-	TX6 - Z12	801 511	½" x ⅝"
28.0	-	-	TX6 - Z13	801 512	12 mm x 16 mm
28.0	-	-	TX6 - Z13	801 513	½" x ⅝"
40.0	-	-	TX6 - Z14	801 514	16 mm x 22 mm
40.0	-	-	TX6 - Z14	801 515	⅝" x ⅞"
50.0	-	-	TX6 - Z15	801 516	16 mm x 22 mm
50.0	-	-	TX6 - Z15	801 517	⅝" x ⅞"
74.0	-	-	TX6 - Z16	801 518	22 mm x 28 mm
74.0	-	-	TX6 - Z16	801 519	⅞" x 1-⅛"
97.0	-	-	TX6 - Z17	801 520	22 mm x 28 mm
97.0	-	-	TX6 - Z17	801 521	⅞" x 1-⅛"

Nominal capacity (Qn) is based on the following conditions:

Refrigerant	Evaporating temperature	Condensing temperature	Subcooling
R407C	+4°C dew point	+38°C bubble p. +43°C dew point	1K
R22, R134a, R410A	+4°C	+38°C	1K

Valve selection for other operating conditions see "Correction Tables for Thermo-Expansion Valves Series TI, TX3, TX6, T and L" or use Copeland Select (download from www.emersonclimate.eu).

Thermo™-Expansion Valve Series T

Exchangeable Power Assemblies and Orifices

Features

- Modular design for economical logistics and easy assembly and servicing
- Very good stability is attained because of the large forces generated by the large diaphragm diameter
- High-quality materials and processes for high reliability and long lifetime
- Superior partial load performance due to double seat orifice design (TJRE, TERE, TIRE & THRE)
- Biflow capability for applications in heat pumps
- Capillary tube length 1.5 m (TCLE, TJRE) and 3m (TERE, TIRE & THRE)
- PS: 46 / 31 bar with XB / XC power assembly.
- TS: -45 ... +65°C
- No CE marking according art. 3.3 PED 97/23 EC



TCLE

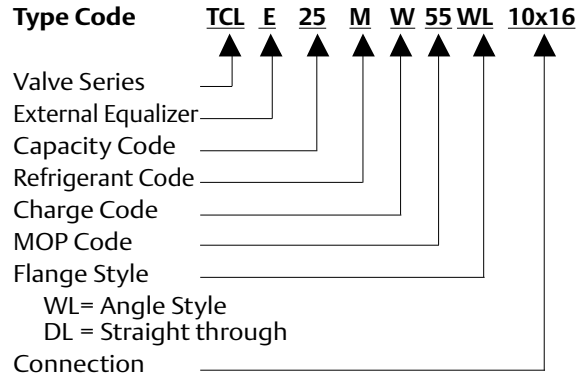

Selection Chart for Orifices

Series	R134a		R404A/R507		R407C		R410A		Orifice
	Type	Nominal Capacity kW	Type	Nominal Capacity kW	Type	Nominal Capacity kW	Type	Nominal Capacity kW	
TCLE	25 MW	1.5	25 SW	1.3	50 NW	2.1	50ZW	2.2	X 22440-B1B
	75 MW	2.9	75 SW	2.6	100 NW	4.0	100ZW	4.3	X 22440-B2B
	150 MW	6.1	150 SW	5.6	200 NW	8.5	250ZW	9.2	X 22440-B3B
	200 MW	9.3	200 SW	8.4	300 NW	12.9	400ZW	13.9	X 22440-B3.5B
	250 MW	13.5	250 SW	12.2	400 NW	18.7	600ZW	20.2	X 22440-B4B
	350 MW	17.3	400 SW	15.7	550 NW	24.0	750ZW	25.9	X 22440-B5B
	550 MW	23.6	600 SW	21.5	750 NW	32.9	1000ZW	35.5	X 22440-B6B
	750 MW	32.0	850 SW	29.0	1000 NW	44.4	1400ZW	48.0	X 22440-B7B
	900 MW	37.2	1000 SW	33.8	1150 NW	51.7	1600ZW	55.8	X 22440-B8B
TJRE	11 MW	45	12 SW	40	14 NW	62	19ZW	67.7	X 11873-B4B
	13 MW	57	14 SW	51	17 NW	80	25ZW	86.4	X 11873-B5B
TERE	16 MW	71	18 SW	63	21 NW	99	-	-	X 9117-B6B
	19 MW	81	20 SW	72	25 NW	112	-	-	X 9117-B7B
	25 MW	112	27 SW	99	33 NW	155	-	-	X 9117-B8B
	31 MW	135	34 SW	120	42 NW	188	-	-	X 9117-B9B
TIRE	45 MW	174	47 SW	154	52 NW	241	-	-	X 9166-B10B
THRE	55 MW	197	61 SW	174	71 NW	273	-	-	X 9144-B11B
	68 MW	236	77 SW	209	94 NW	327	-	-	X 9144-B13B

MOP		Evaporating Temperature Range °C				
Code	bar	R134a MW	R404A SW	R407C NW	R507 SW	R410 ZW
35	2.4	-45 .. 0				
40	2.8		-45 .. -18		-45 .. -18	
55	3.8	-45 .. 11	-45 .. -10		-45 .. -10	
65	4.5					
75	5.2		-45 .. -2		-45 .. -2	
80	5.5		-45 .. 0		-45 .. 0	
100	6.9			-45 .. 14		
175	12.1					-45 .. 16

Nominal capacity (Qn) is based on the following conditions:

Refrigerant	Evaporating temperature	Condensing temperature	Subcooling
R407C	+4°C dew point	+38°C bubble point +43°C dew point	1K
R134a, R410A	+4°C	+38°C	1K

Valve selection for other operating conditions see "Correction Tables for Thermo-Expansion Valves Series TI, TX3, TX6, T and L" or use Copeland Select (download from www.emersonclimate.eu).

Available upon special request:

- Power assembly with solder connection for external pressure equalization
- Non-standard MOPs
- Non-standard charges
- Non-standard connection sizes. See last page of this chapter

Type Code

XB 1019 M W 55 - 1 B

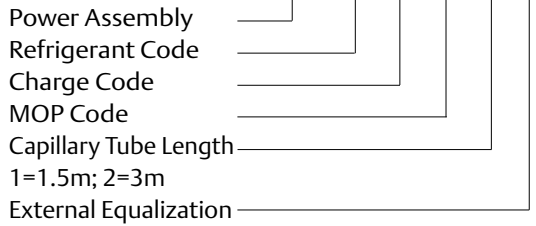

Selection Chart for Power Assemblies and Recommended Flanges

Orifice	Connection Standard-Flange. Angle (see last page of this chapter) Solder/ODF		Power Assembly
	mm	inch	
X 22440-B1B	C 501 - 5 mm 10 x 16	C 501 - 5 3/8 x 5/8	XB1019...1B
X 22440-B2B			
X 22440-B3B			
X 22440-B3.5B			
X 22440-B4B			
X 22440-B5B	C 501 - 7 mm 12 x 16	C 501 - 7 1/2 x 5/8	
X 22440-B6B	A 576 mm 16 x 22 (22 x 28 ODM)	A 576 3/8 x 7/8 (1 1/8 x 1 1/8 ODM)	
X 22440-B7B			
X 22440-B8B			
X 11873-B4B	10331 22 x 22	10331 3/8 x 7/8 (1 1/8 x 1 1/8 ODM)	
X 11873-B5B	9153 mm 22 x 22	9153 3/8 x 7/8 (1 1/8 x 1 1/8 ODM)	XC726...2B
X 9117-B6B			
X 9117-B7B			
X 9117-B8B			
X 9117-B9B			
X 9166-B10B			
X 9144-B11B	9149 22 x 22	9149 3/8 x 7/8 (1 1/8 x 1 1/8 ODM)	
X 9144-B13B			

Spare Parts

	Type	Part No.
Gasket Set for T Series Valves	X 13455 -1	027 579
Service Tool for T Series Valves	X 99999	800 005
Steel screws for following flange types: C501, 9761, 6346, A576 9148, 9149, 9152, 9153, 10331, 10332	Screw ST 32 Screw ST 48	803 573 803 574

Correction Tables for Thermo™-Expansion Valves Series TI, TX3, TX6, T and L

Valve selection for operating conditions
other than nominal conditions:

$$Q_n = Q_o \times K_t \times K_{\Delta p}$$

Q_n : Nominal valve capacity

K_t : Correction factor for evaporating and liquid temperature

Q_o : Required cooling capacity

$K_{\Delta p}$: Correction factor for pressure drop at valve

Liquid Temperature entering Valve °C	R410A				Correction Factor k_t Evaporating Temperature (°C)													
	+20	+15	+10	+5	0	-5	-10	-15	-20	-25	-30	-35	-40	-45				
+65	1.75	1.76	1.78	1.80	1.83	1.86	1.89	2.18	2.55	3.05	3.69	4.49	5.46	6.62				
+60	1.49	1.50	1.51	1.53	1.54	1.57	1.59	1.83	2.14	2.55	3.08	3.73	4.52	5.45				
+55	1.31	1.32	1.33	1.35	1.36	1.38	1.40	1.61	1.87	2.23	2.68	3.25	3.92	4.72				
+50	1.19	1.20	1.20	1.21	1.23	1.24	1.26	1.44	1.68	2.00	2.40	2.90	3.49	4.20				
+45	1.01	1.09	1.10	1.11	1.12	1.13	1.15	1.32	1.53	1.82	2.18	2.63	3.17	3.80				
+40	0.94	1.01	1.02	1.03	1.04	1.05	1.06	1.21	1.41	1.67	2.01	2.41	2.90	3.48				
+35	0.88	0.94	0.95	0.96	0.97	0.98	0.99	1.13	1.31	1.55	1.86	2.24	2.69	3.21				
+30	0.83	0.89	0.89	0.90	0.91	0.91	0.92	1.06	1.22	1.45	1.74	2.09	2.50	2.99				
+25		0.84	0.84	0.85	0.85	0.86	0.87	0.99	1.15	1.36	1.63	1.96	2.35	2.80				
+20		0.79	0.80	0.80	0.81	0.81	0.82	0.94	1.09	1.29	1.54	1.84	2.21	2.64				
					Correction Factor $k_{\Delta p}$													
Δp (bar)	1	2	3	4	5	6	7	8	9	10	11	12	13	14	15	16		
$K_{\Delta p}$	3.74	2.65	2.16	1.87	1.67	1.53	1.41	1.32	1.25	1.18	1.13	1.08	1.04	1.00	0.97	0.94		
Δp (bar)	17	18	19	20	21	22	23	24	25	26	27	28	29	30	31	32		
$K_{\Delta p}$	0.91	0.88	0.86	0.84	0.82	0.80	0.78	0.76	0.75	0.73	0.72	0.71	0.69	0.68	0.67	0.66		
Liquid Temperature entering Valve °C	R134a				Correction Factor k_t Evaporating Temperature (°C)													
	+30	+25	+20	+15	+10	+5	0	-5	-10	-15	-20	-25	-30					
+60	1.22	1.25	1.27	1.30	1.33	1.36	1.40	1.44	1.48	1.75	2.08	2.46	2.94					
+55	1.14	1.16	1.18	1.21	1.23	1.26	1.29	1.33	1.36	1.60	1.90	2.25	2.68					
+50	1.07	1.08	1.10	1.13	1.15	1.17	1.20	1.23	1.26	1.48	1.76	2.07	2.46					
+45	1.00	1.02	1.04	1.06	1.08	1.10	1.12	1.15	1.17	1.38	1.63	1.92	2.28					
+40	0.93	0.96	0.98	0.99	1.01	1.03	1.05	1.08	1.10	1.29	1.52	1.79	2.12					
+35	0.90	0.91	0.92	0.94	0.96	0.97	0.99	1.01	1.03	1.21	1.43	1.68	1.99					
+30	0.85	0.86	0.88	0.89	0.91	0.92	0.94	0.96	0.98	1.14	1.35	1.58	1.87					
+25		0.82	0.83	0.85	0.86	0.87	0.89	0.91	0.92	1.08	1.27	1.49	1.76					
+20			0.80	0.81	0.82	0.83	0.85	0.89	0.88	1.02	1.21	1.41	1.67					
+15				0.77	0.78	0.79	0.81	0.82	0.84	0.97	1.15	1.34	1.58					
+10					0.75	0.76	0.77	0.78	0.80	0.93	1.09	1.28	1.51					
+5						0.73	0.74	0.75	0.76	0.89	1.04	1.22	1.44					
0							0.71	0.72	0.73	0.85	1.00	1.17	1.37					
-5								0.69	0.70	0.82	0.96	1.12	1.31					
-10									0.68	0.79	0.92	1.07	1.26					
					Correction Factor $k_{\Delta p}$													
Δp (bar)	0.5	1.0	1.5	2.0	2.5	3.0	3.5	4.0	4.5	5.0	5.5	6.0	6.5	7.0	7.5	8.0		
$K_{\Delta p}$	3.50	2.48	2.02	1.75	1.57	1.43	1.32	1.24	1.17	1.11	1.06	1.01	0.97	0.94	0.90	0.88		
Δp (bar)	8.5	9.0	9.5	10.0	10.5	11.0	11.5	12.0	12.5	13.0	13.5	14.0	14.5	15.0	15.5	16.0		
$K_{\Delta p}$	0.85	0.83	0.80	0.78	0.76	0.75	0.73	0.72	0.69	0.66	0.64	0.62	0.60	0.58	0.57	0.55		

In cases of subcooling of more than 15K please additionally use the correction factors on first page of this chapter.

Liquid Temperature entering Valve °C	R404A				Correction Factor k_t Evaporating Temperature (°C)											
	+30	+25	+20	+15	+10	+5	0	-5	-10	-15	-20	-25	-30	-35	-40	-45
+60	1.56	1.59	1.64	1.69	1.74	1.81	1.88	1.96	2.06	2.43	2.95	3.56	4.37	5.38	6.71	8.47
+55	1.32	1.35	1.38	1.42	1.46	1.50	1.55	1.61	1.68	1.96	2.36	2.83	3.43	4.16	5.12	6.34
+50	1.16	1.18	1.20	1.23	1.26	1.30	1.34	1.38	1.43	1.67	1.99	2.37	2.85	3.43	4.18	5.14
+45	1.04	1.05	1.07	1.10	1.12	1.15	1.18	1.22	1.26	1.46	1.74	2.05	2.46	2.95	3.57	4.35
+40	0.94	0.96	0.97	0.99	1.02	1.04	1.07	1.09	1.13	1.30	1.55	1.82	2.17	2.59	3.13	3.80
+35	0.87	0.88	0.90	0.91	0.93	0.95	0.97	1.00	1.02	1.18	1.40	1.64	1.96	2.33	2.80	3.38
+30	0.81	0.82	0.83	0.84	0.86	0.88	0.90	0.92	0.94	1.08	1.28	1.50	1.78	2.11	2.53	3.05
+25		0.76	0.77	0.79	0.80	0.82	0.83	0.85	0.87	1.00	1.18	1.39	1.64	1.94	2.32	2.79
+20			0.73	0.74	0.75	0.77	0.78	0.80	0.81	0.94	1.10	1.29	1.52	1.80	2.15	2.58
+15				0.70	0.71	0.72	0.73	0.75	0.76	0.88	1.03	1.21	1.42	1.68	2.00	2.40
+10					0.67	0.68	0.69	0.71	0.72	0.83	0.97	1.13	1.34	1.58	1.88	2.25
+5						0.65	0.66	0.67	0.68	0.78	0.92	1.07	1.26	1.49	1.77	2.11
0							0.63	0.64	0.65	0.75	0.88	1.02	1.20	1.41	1.67	2.00
-5								0.61	0.62	0.71	0.83	0.97	1.14	1.34	1.59	1.90
-10									0.60	0.68	0.80	0.93	1.09	1.28	1.52	1.81
	Correction Factor $k_{\Delta p}$															
Δp (bar)	0.5	1.0	1.5	2.0	2.5	3.0	3.5	4.0	4.5	5.0	5.5	6.0	6.5	7.0	8.0	9.0
$K_{\Delta p}$	4.55	3.21	2.62	2.27	2.03	1.86	1.72	1.61	1.52	1.44	1.37	1.31	1.26	1.21	1.14	1.07
Δp (bar)	10.0	11.0	12.0	13.0	14.0	15.0	16.0	17.0	18.0	19.0	20.0	21.0	22.0	23.0	24.0	25.0
$K_{\Delta p}$	1.02	0.97	0.93	0.89	0.86	0.83	0.80	0.78	0.76	0.74	0.72	0.70	0.69	0.67	0.66	0.64

In cases of subcooling of more than 15K please additionally use the correction factors on first page of this chapter.

Liquid Temperature entering Valve °C	R407C				Correction Factor kt Evaporating Temperature (°C)											
	+30	+25	+20	+15	+10	+5	0	-5	-10	-15	-20	-25				
+55	1.20	1.21	1.23	1.26	1.28	1.31	1.34	1.37	1.40	1.63	1.98	2.42				
+50	1.10	1.11	1.13	1.15	1.17	1.19	1.22	1.24	1.27	1.48	1.79	2.18				
+45	1.02	1.03	1.05	1.06	1.08	1.10	1.12	1.14	1.17	1.35	1.64	2.00				
+40	0.95	0.96	0.98	0.99	1.01	1.02	1.04	1.06	1.08	1.25	1.52	1.84				
+35	0.89	0.90	0.92	0.93	0.94	0.96	0.98	0.99	1.01	1.17	1.41	1.71				
+30	0.85	0.85	0.87	0.88	0.89	0.90	0.92	0.93	0.95	1.10	1.32	1.60				
+25		0.81	0.82	0.83	0.84	0.85	0.87	0.88	0.90	1.03	1.25	1.51				
+20			0.78	0.79	0.80	0.81	0.82	0.84	0.85	0.98	1.18	1.43				
+15				0.75	0.76	0.77	0.78	0.80	0.81	0.93	1.12	1.35				
+10					0.73	0.74	0.75	0.76	0.77	0.89	1.07	1.29				
+5						0.71	0.72	0.73	0.74	0.85	1.02	1.23				
0							0.69	0.70	0.71	1.00	0.98	1.18				
-5								0.67	0.68	0.78	0.94	1.13				
-10									0.65	0.75	0.90	1.08				
Correction Factor kΔp																
Δp (bar)	0.5	1.0	1.5	2.0	2.5	3.0	3.5	4.0	4.5	5.0	5.5	6.0	6.5	7.0	8.0	9.0
KΔp	4.78	3.33	2.72	2.36	2.11	1.92	1.78	1.67	1.57	1.49	1.42	1.36	1.31	1.26	1.18	1.11
Δp (bar)	10.0	11.0	12.0	13.0	14.0	15.0	16.0	17.0	18.0	19.0	20.0	21.0	22.0	23.0	24.0	25.0
KΔp	1.05	1.01	0.96	0.92	0.89	0.86	0.83	0.81	0.79	0.76	0.75	0.73	0.71	0.70	0.68	0.67

Liquid Temperature entering Valve °C	R507				Correction Factor kt Evaporating Temperature (°C)											
	+30	+25	+20	+15	+10	+5	0	-5	-10	-15	-20	-25	-30	-35	-40	-45
+60	1.54	1.57	1.61	1.65	1.71	1.76	1.83	1.90	1.98	2.36	2.84	3.44	4.23	5.25	6.61	8.45
+55	1.30	1.33	1.36	1.39	1.43	1.47	1.52	1.57	1.62	1.92	2.29	2.75	3.35	4.11	5.11	6.44
+50	1.15	1.17	1.19	1.22	1.24	1.28	1.31	1.35	1.40	1.64	1.95	2.33	2.81	3.43	4.23	5.29
+45	1.03	1.05	1.07	1.09	1.11	1.14	1.17	1.20	1.23	1.45	1.71	2.04	2.45	2.97	3.64	4.53
+40	0.94	0.96	0.97	0.99	1.01	1.03	1.06	1.08	1.11	1.30	1.53	1.82	2.18	2.63	3.22	3.98
+35	0.87	0.88	0.90	0.91	0.93	0.95	0.97	0.99	1.01	1.18	1.39	1.65	1.97	2.37	2.89	3.56
+30	0.81	0.82	0.83	0.85	0.86	0.88	0.89	0.91	0.93	1.09	1.28	1.51	1.80	2.17	2.63	3.23
+25		0.77	0.78	0.79	0.80	0.82	0.83	0.85	0.87	1.01	1.18	1.40	1.66	1.99	2.42	2.97
+20			0.73	0.74	0.75	0.77	0.78	0.79	0.81	0.94	1.10	1.30	1.54	1.85	2.24	2.74
+15				0.70	0.71	0.72	0.73	0.75	0.76	0.88	1.03	1.21	1.44	1.73	2.09	2.55
+10					0.67	0.68	0.69	0.70	0.72	0.83	0.97	1.14	1.35	1.62	1.95	2.38
+5						0.64	0.65	0.67	0.68	0.78	0.92	1.07	1.27	1.52	1.83	2.23
0							0.62	0.63	0.64	0.74	0.87	1.02	1.20	1.43	1.73	2.10
-5								0.60	0.61	0.70	0.82	0.96	1.14	1.35	1.63	1.98
-10									0.58	0.67	0.78	0.91	1.08	1.28	1.54	1.87
Correction Factor kΔp																
Δp (bar)	0.5	1.0	1.5	2.0	2.5	3.0	3.5	4.0	4.5	5.0	5.5	6.0	6.5	7.0	8.0	9.0
KΔp	4.63	3.27	2.67	2.31	2.07	1.89	1.75	1.64	1.54	1.46	1.40	1.34	1.28	1.24	1.16	1.09
Δp (bar)	10.0	11.0	12.0	13.0	14.0	15.0	16.0	17.0	18.0	19.0	20.0	21.0	22.0	23.0	24.0	25.0
KΔp	1.03	0.99	0.94	0.91	0.87	0.85	0.82	0.79	0.77	0.75	0.73	0.71	0.70	0.68	0.67	0.65

In cases of subcooling of more than 15K please additionally use the correction factors on first page of this chapter.

Liquid Temperature entering Valve °C	R407F				Correction Factor kt Evaporating Temperature (°C)									
	+20	+15	+10	+5	0	-5	-10	-15	-20	-25	-30	-35	-40	-45
+65	1.51	1.53	1.55	1.58	1.61	1.64	1.68	1.90	2.24	2.68	3.22	3.86	4.63	5.52
+60	1.35	1.37	1.39	1.41	1.43	1.46	1.49	1.68	1.98	2.36	2.83	3.39	4.04	4.81
+55	1.23	1.25	1.26	1.28	1.30	1.32	1.35	1.52	1.79	2.13	2.54	3.04	3.62	4.30
+50	1.14	1.15	1.16	1.18	1.20	1.22	1.24	1.39	1.64	1.95	2.32	2.77	3.29	3.90
+45	1.06	1.07	1.08	1.10	1.11	1.13	1.14	1.29	1.51	1.79	2.14	2.55	3.02	3.57
+40	0.99	1.00	1.01	1.02	1.04	1.05	1.07	1.20	1.41	1.67	1.98	2.36	2.80	3.31
+35	0.93	0.94	0.95	0.96	0.97	0.99	1.00	1.12	1.32	1.56	1.85	2.20	2.61	3.08
+30	0.88	0.89	0.90	0.91	0.92	0.93	0.94	1.06	1.24	1.47	1.74	2.07	2.44	2.88
+25	0.83	0.84	0.85	0.86	0.87	0.88	0.89	1.00	1.17	1.38	1.64	1.95	2.30	2.71
+20	0.79	0.80	0.81	0.82	0.82	0.83	0.84	0.95	1.11	1.31	1.55	1.84	2.17	2.56
+15	0.76	0.76	0.77	0.78	0.78	0.79	0.80	0.90	1.05	1.24	1.47	1.74	2.06	2.42
+10	0.72	0.73	0.74	0.74	0.75	0.76	0.77	0.86	1.00	1.18	1.40	1.66	1.96	2.30
+5	0.69	0.70	0.70	0.71	0.72	0.72	0.73	0.82	0.96	1.13	1.34	1.58	1.87	2.19
0	0.66	0.67	0.68	0.68	0.69	0.69	0.70	0.79	0.92	1.08	1.28	1.51	1.78	2.09
-5	0.64	0.64	0.65	0.65	0.66	0.67	0.67	0.75	0.88	1.04	1.23	1.45	1.71	2.00
-10	0.62	0.62	0.62	0.63	0.63	0.64	0.65	0.72	0.84	1.00	1.18	1.39	1.64	1.92
	Correction Factors (kΔp)													
ΔP (bar)	1	1.5	2	2.5	3	3.5	4	4.5	5	5.5	6	6.5	7	7.5
k_{Δp}	3.51	2.87	2.48	2.22	2.03	1.88	1.76	1.66	1.57	1.5	1.43	1.38	1.33	1.28
ΔP (bar)	8	9	10	11	12	13	14	15	16	17	18	19	20	21
k_{Δp}	1.24	1.17	1.11	1.06	1.01	0.97	0.94	0.91	0.88	0.85	0.83	0.81	0.79	0.77

In cases of subcooling of more than 15K please additionally use the correction factors on first page of this chapter.

Superheat adjustment guidelines when TI Valves TI/TIE/TIS/TISE/TILE-NW, designed for R407C are used in applications with R407F

Standard charge (refrigerant)	Alternative refrigerant	Evaporating temperature °C				
		-40	-30	-20	-10	0
		Number of turns				
NW (R407C)	R407F	-3/4	-1	-1 1/2	-2 1/4	-3

Minus means counterclockwise

Thermo™ -Expansion Valve Series ZZ

for Low Evaporating Temperatures between -45 and -120°C

Features

- Modular design for economical logistics and easy assembly and servicing
- Very good stability is attained because of the large forces generated by the large diaphragm diameter
- High-quality materials and processes for high reliability and long lifetime
- Capillary tube length 3 m
- PS: 31 bar. TS: -120 ... +65°C
- No CE marking according art. 3.3 PED 97/23 EC

Type Code

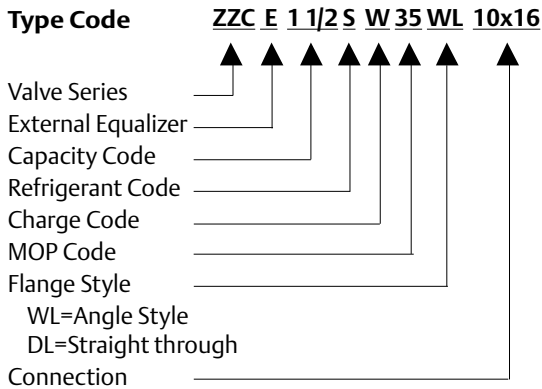

ZZCE

XC 726 S W 35 - 2 B

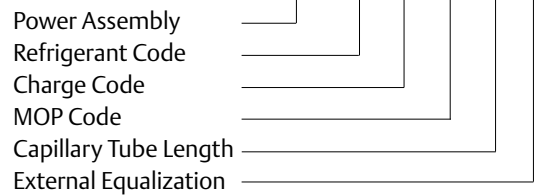

Available upon special request:

- Power assembly with solder connection for external pressure equalization
- Non-standard MOPs
- Non-standard charges
- Non-standard connection sizes (Selection see last page of this chapter)

Series	R23		R404A / R507		Orifice	Connection Standard-Flange, Angle Solder/ODF		Power Assembly
	Type	Nominal Capacity kW	Type	Nominal Capacity kW		mm	inch	
						2 BG	1.9	
6 BG	4.0	1 1/2 SW	2.6	X 10-B02				
8 BG	6.8	2 1/2 SW	4.4	X 10-B03				
ZZCE	12 BG	10.8	3 1/2 SW	7.0	X 10-B04	C501 - 7mm 12 X 16	C501 - 7 1/2" X 3/8"	
	17 BG	16.3	5 SW	10.6	X 10-B05			
	25 BG	21.7	8 SW	14.1	X 10-B06	A 576mm 16 X 22 (22 X 28 ODM)	A 576 5/8" X 7/8" (1/2" X 1 1/8" ODM)	
	31 BG	27.1	9 SW	17.6	X 10-B07			

Attention: To withstand stress at extremely low temperatures, thermo expansion valves series ZZ feature bronze bolts.

Preferred MOPs				
MOP Code	MOP		Evaporating Temperature Range °C	
	bar	Tmax	R23	R404A/R507
20	1.4	-66°C	-100 ... -71	
35	2.4	-11°C		
40	2.8	-14°C		-75 ... -18
55	3.8	-7°C		-75 ... -10
60	4.1	-48°C	-100 ... -51	
125	8.6	-32°C	-100 ... -35	

Nominal capacity (Qn) is based on the following conditions:

Refrigerant	R22	R23	R404/R507
Evaporating temperature (°C)	-40	-60	-40
Condensing temperature (°C)	25	-25	25
Subcooling (K)	1	1	1

Valve selection at other operating conditions see "Correction Tables for Series ZZ"

Spare Parts

	Type	Part No.
Gasket Set for for ZZ Series Valves	X 13455 -1	027 579
Service Tool for for ZZ Series Valves	X 99999	800 005
Bronze screws for following flange types: C501, 9761, 6346, A576 9148, 9149, 9152, 9153, 10331, 10332	Screw BZ 32 Screw BZ 48	803 575 803 576

Correction Tables for Series ZZ

Valve selection for other operating conditions:

$$Q_n = Q_o \times K_t \times K_{\Delta p}$$

- Q_n : Nominal valve capacity
 Q_o : Required cooling capacity
 K_t : Correction factor for evaporating and liquid temperature
 $K_{\Delta p}$: Correction factor for pressure drop at valve

Liquid Temperature entering Valve °C	R23				Correction Factor kt Evaporating Temperature (°C)							
	-45	-50	-55	-60	-65	-70	-75	-80	-85	-90	-95	-100
-10	1.18	1.18	1.19	1.21	1.28	1.48	1.86	2.21	2.73	3.36	4.15	5.06
-15	1.11	1.11	1.12	1.13	1.20	1.39	1.74	2.07	2.56	3.14	3.88	4.72
-20	1.04	1.05	1.06	1.07	1.13	1.31	1.64	1.95	2.41	2.95	3.64	4.43
-25	0.99	0.99	1.00	1.01	1.07	1.24	1.55	1.84	2.27	2.78	3.43	4.17
-30	0.94	0.94	0.95	0.96	1.02	1.17	1.47	1.75	2.15	2.63	3.24	3.94
-35	0.89	0.90	0.91	0.91	0.97	1.12	1.40	1.66	2.04	2.50	3.08	3.74
-40	0.85	0.86	0.86	0.87	0.92	1.06	1.33	1.58	1.94	2.38	2.92	3.55
-45		0.82	0.83	0.83	0.88	1.02	1.27	1.51	1.85	2.27	2.79	3.38
-50			0.79	0.80	0.84	0.97	1.22	1.44	1.77	2.17	2.86	3.23
-55				0.76	0.81	0.93	1.17	1.38	1.70	2.07	2.55	3.09
-60					0.78	0.90	1.12	1.33	1.63	1.99	2.44	2.96
-65						0.86	1.08	1.27	1.57	1.91	2.35	2.84
-70							1.04	1.23	1.51	1.84	2.26	2.73
-75								1.18	1.45	1.77	2.18	2.63
-80									1.40	1.71	2.10	2.54
Correction Factor kΔp												
Δp (bar)	0.5	1.0	1.5	2.0	2.5	3.0	3.5	4.0	4.5	5.0	6.0	7.0
KΔp	4.20	2.97	2.43	2.10	1.88	1.72	1.59	1.49	1.40	1.33	1.21	1.12
Δp (bar)	8.0	9.0	10.0	11.0	12.0	13.0	14.0	15.0	16.0	17.0	18.0	19.0
KΔp	1.05	0.99	0.94	0.90	0.86	0.82	0.79	0.77	0.74	0.72	0.70	0.68

Liquid Temperature entering Valve °C	R404A				Correction Factor kt Evaporating Temperature (°C)							
	-40	-45	-50	-55	-60	-65	-70	-75				
+40	1.40	1.76	2.21	2.77	3.56	4.30	4.87	5.61				
+35	1.24	1.55	1.94	2.42	3.09	3.71	4.17	4.77				
+30	1.12	1.39	1.73	2.15	2.74	3.27	3.66	4.17				
+25	1.02	1.26	1.57	1.94	2.46	2.93	3.27	3.70				
+20	0.94	1.16	1.44	1.77	2.24	2.66	2.96	3.34				
+15	0.87	1.07	1.33	1.63	2.06	2.44	2.71	3.05				
+10	0.81	1.00	1.23	1.52	1.91	2.26	2.49	2.80				
+5	0.76	0.94	1.15	1.42	1.78	2.10	2.32	2.60				
0	0.71	0.88	1.08	1.33	1.67	1.97	2.17	2.43				
-5	0.68	0.83	1.02	1.25	1.57	1.85	2.04	2.28				
-10	0.64	0.79	0.97	1.19	1.49	1.75	1.92	2.14				
-15	0.61	0.75	0.92	1.13	1.41	1.66	1.82	2.03				
-20	0.58	0.72	0.88	1.07	1.34	1.57	1.73	1.92				
-25	0.56	0.69	0.84	1.03	1.28	1.50	1.65	1.83				
-30	0.54	0.66	0.80	0.98	1.22	1.43	1.57	1.75				
-35	0.51	0.63	0.77	0.94	1.17	1.36	1.49	1.66				
-40		0.60	0.74	0.90	1.12	1.31	1.43	1.59				
-45			0.71	0.86	1.07	1.25	1.37	1.52				
-50				0.83	1.03	1.21	1.32	1.46				
Correction Factor kΔp												
Δp (bar)	0.5	1.0	1.5	2.0	2.5	3.0	3.5	4.0	4.5	5.0	6.0	7.0
KΔp	4.73	3.34	2.73	2.36	2.11	1.93	1.79	1.67	1.58	1.50	1.37	1.26
Δp (bar)	8.0	9.0	10.0	11.0	12.0	13.0	14.0	15.0	16.0	17.0	18.0	19.0
KΔp	1.18	1.11	1.06	1.01	0.97	0.93	0.89	0.86	0.84	0.80	0.79	0.77

In cases of subcooling of more than 15K please additionally use the correction factors on first page of this chapter.

Liquid Temperature entering Valve °C	R507				Correction Factor kt Evaporating Temperature (°C)							
	-45	-50	-55	-60	-65	-70						
+30	1.26	1.67	2.10	2.68	3.48	4.58						
+20	1.07	1.41	1.77	2.25	2.89	3.78						
+10	0.94	1.22	1.52	1.92	2.46	3.23						
0	0.83	1.08	1.33	1.68	2.16	2.82						
-10	0.75	0.95	1.19	1.49	1.92	2.48						
-20	0.67	0.86	1.07	1.34	1.70	2.20						
-30	0.61	0.78	0.96	1.21	1.54	2.00						
-40	0.55	0.71	0.86	1.08	1.38	1.79						
-50			0.79	0.99	1.24	1.62						
Correction Factor kΔp												
Δp (bar)	0.5	1.0	1.5	2.0	2.5	3.0	3.5	4.0	4.5	5.0	6.0	7.0
KΔp	4.77	3.37	2.75	2.38	2.13	1.95	1.80	1.69	1.59	1.51	1.38	1.27
Δp (bar)	8.0	9.0	10.0	11.0	12.0	13.0	14.0	15.0	16.0	17.0	18.0	19.0
KΔp	1.19	1.12	1.07	1.02	0.97	0.94	0.90	0.87	0.84	0.82	0.79	0.77

In cases of subcooling of more than 15K please additionally use the correction factors on first page of this chapter.

Liquid Injection Valve Series L

Exchangeable Power Assemblies and Orifices

Features

- Applications for Series L valves include superheat control (desuperheating of suction gas i.e., in hotgas bypass systems and interstage cooling in multiple stage compressors)
- Modular design for economical logistics and easy assembly and servicing
- Very good stability is attained because of the large forces generated by the large diaphragm diameter
- High-quality materials and processes for high reliability and long lifetime
- Superior partial load performance due to seat orifice design (LJRE, LERE & LIRE)
- Capillary tube length 3 m
- PS: 46 / 31 bar with XB / XC power assembly
- TS: -45 ... +65°C
- No CE marking according art. 3.3 PED 97/23 EC



LCLE

Type Code

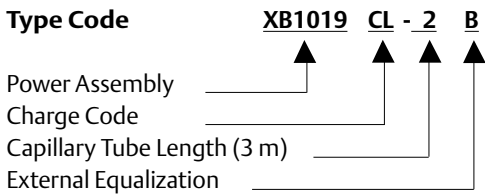

Type Code

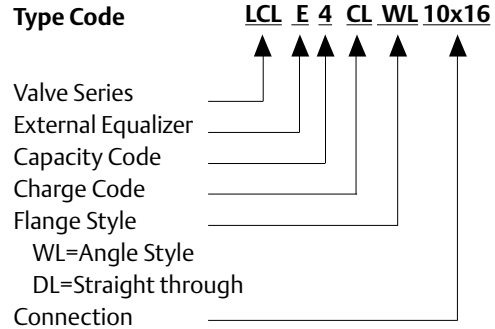

Series		Nominal Capacity Q _n kW			Orifice	Connections Standard Flange. Angle Solder/ODF		Power Assembly
		R134a	R404A/ R507	R407C		mm	inch	
LCLE	1 *	1.5	1.3	2.1	X 22440-B1B	C 501 – 5 mm 10 x 16	XB1019...2B	
	2 *	2.9	2.6	4.0	X 22440-B2B			
	3 *	6.1	5.6	8.5	X 22440-B3B			
	3.5 *	9.3	8.4	12.9	X 22440-B3.5B			
	4 *	13.5	12.2	18.7	X 22440-B4B	C 501 – 7 mm 12 x 16		
	6 *	17.3	15.7	24.0	X 22440-B5B			
	7 *	23.6	21.5	32.9	X 22440-B6B	A 576 mm 16 x 22 (22 x 28 ODM)		
	9 *	32.0	29.0	44.4	X 22440-B7B			A 576 5/8 x 7/8 (7/8 x 1 1/8 ODM)
LJRE	11 *	45	40	62	X 11873-B4B	10331 22 x 22	10331 7/8 x 7/8 (1 1/8 x 1 1/8 ODM)	
	12 *	57	51	80	X 11873-B5B			
LERE	13 *	71	63	99	X 9117-B6B	9153 mm 22 x 22	9153 7/8 x 7/8 (1 1/8 x 1 1/8 ODM)	XC726...2B
	14 *	81	72	112	X 9117-B7B			
	15 *	112	99	155	X 9117-B8B			
	16 *	135	120	188	X 9117-B9B			
LIRE	17 *	174	154	241	X 9166-B10B			

Superheat selection

* Charge Code	Refrigerant				
	R134a	R404A/R507	R407A	R407F	R407C
CL		22 K	22 K	22 K	13 K
GL	15 K	35 K	35 K	35 K	25 K
UL	30 K				40 K

* Please indicate designation character for desired superheat

Nominal capacity (Q_n) is based on the following conditions:

Refrigerant	Evaporating temperature	Condensing temperature	Sub- cooling
R407C	+4°C dew point	+38°C bubble point +43°C dew point	1K
R134a, R404A, R507	+4°C	+38°C	1K

Valve selection for other operating conditions see "Correction Tables for Thermo-Expansion Valves Series T1, TX3, TX6, T and L"

Available upon special request

- Power assembly with solder connection for external pressure equalization
- Non-standard connection sizes see last page of this chapter

Spare Parts

	Type	Part No.
Gasket Set for L Series Valves	X 13455 -1	027 579
Service Tool for L Series Valves	X 99999	800 005
Steel screws for following flange types: C501, 9761, 6346, A576 9148, 9149, 9152, 9153, 10331, 10332	Screw ST 32 Screw ST 48	803 573 803 574

Correction Tables for Series L

Valve selection for desuperheating of suction gas:

The required desuperheating capacity Q_{des} has to be multiplied with the correction factors on "Correction Tables for Thermo-Expansion Valves Series TI, TX3, TX6, T and L".

$$Q_{des} \times K_t \times K_{\Delta p} = Q_n$$

- Q_{des} : Required desuperheating capacity
 K_t : Correction factor for evaporating and liquid temperature
 $K_{\Delta p}$: Correction factor for pressure drop at valve
 Q_n : Nominal valve capacity

Valve selection for desuperheating of suction gas in conjunction with hotgas-bypass regulation:

The required bypass capacity Q_{Byp} has to be multiplied with correction factor K_{ti} per table below.

$$Q_{Byp} \times K_{ti} = Q_n$$

- Q_{Byp} : Required bypass capacity
 K_{ti} : Correction factor for evaporating temperature
 Q_n : Nominal valve capacity

Condensing Temperature Bubble point °C	Refrigerant	Correction Factor k_{ti} Evaporating Temperature (°C)							
		+10	+5	0	-10	-20	-30	-40	-50
+50 (R407C: + 54 dew point)	R407C	0.41	0.45	0.49	0.58	0.69			
	R134a	0.38	0.42	0.44	0.54	0.64			
	R507/R404A	0.50	0.54	0.59	0.70	0.83	0.98	1.18	1.38
+40 (R407C: + 45 dew point)	R407C	0.32	0.35	0.39	0.46	0.55			
	R134a	0.31	0.33	0.36	0.44	0.52			
	R507/R404A	0.38	0.42	0.45	0.54	0.64	0.76	0.90	1.08
+30 (R407C: + 35 dew point)	R407C	0.25	0.28	0.31	0.37	0.45			
	R134a	0.24	0.26	0.29	0.35	0.43			
	R507/R404A	0.29	0.32	0.35	0.42	0.51	0.60	0.72	0.86
+20 (R407C: + 26 dew point)	R407C	0.19	0.21	0.24	0.30	0.37			
	R134a	0.18	0.20	0.22	0.28	0.35			
	R507/R404A	0.22	0.25	0.27	0.33	0.40	0.48	0.58	0.70

Correction factors based on 20K superheat suction gas at the inlet of compressor, discharge temperature 28K above isentropic compression and 1K subcooling.

Liquid Injection Valves Series 935

Exchangeable Power Assemblies and Orifices

Applications

- Series 935 valves are applied as temperature controls.
- Applications include:
 - Desuperheating of discharge gas on compressors. In this case bulbs are mounted on the high pressure outlet of the compressor
 - Control of compressor oil temperatures
- Series 935 valves shall not be used to control superheat

Features

- Modular design for economical logistics and easy assembly and servicing
- Very good stability because of the large forces generated by the large diaphragm diameter
- High-quality materials and processes for high reliability and long lifetime
- Combinations of different charges with various orifice springs cover a very large application range
- PS: 46 bar
- TS: -45 ... +65°C
- No CE marking according art. 3.3 PED 97/23 EC
- Non-standard connection sizes see last page of this chapter



935

Type Code

Valve Series
 Temperature Code
 Capacity Code
 Flange Style
 WL=Angle Style
 DL=Straight through
 Connection Size

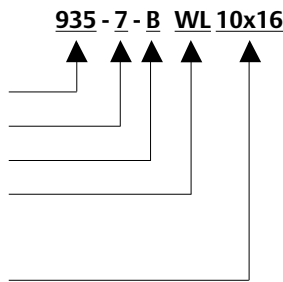

Type Code

Power Assembly
 Charge Code
 Capillary Tube Length (3m)

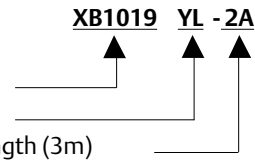

Series		Nominal Capacity Q _n kW					Orifice	Standard Flange. Angle Solder/ODF		Power Assembly
		R134a	R410A	R404A/R507	R407C	R407F		mm	inch	
935-*	A	4.0	6.1	3.8	5.6	5.8	X10- [*] 01	C 501 - 5 mm 10 x 16	C 501 - 5 ⅜ x ⅝	XB1019 - * - 2A
	B	7.8	11.8	7.4	10.9	11.3	X10- [*] 02			
	C	11.1	16.6	10.3	15.4	15.9	X10- [*] 03			
	D	16.3	24.6	15.6	22.8	23.6	X10- [*] 04	C 501 - 7 mm 12 x 16	C 501 - 7 ½ x ⅝	
	E	22.5	33.7	21.0	31.2	32.3	X10- [*] 05	A 576 mm 16 x 22 (22 x 28 ODM)	A 576 ⅝ x ⅞ (⅞ x 1-⅞ ODM)	
	G	32.0	48.1	29.9	44.5	46.1	X10- [*] 06			
	X	46.6	70.0	43.5	64.9	67.1	X10- [*] 07			
* = Temperature Code		Temperature Range °C				* = Spring Code				* = Charge Code
3		-1 / +17				B				UL
6		+14 / +38				C				KL
105		+44 / +70				C				YL
106		+66 / +94				C				JL
100		+94 / +121				C				LL

Nominal capacity (Q_n) is based on the following conditions:

Refrigerant	Evaporating temperature	Condensing temperature	Subcooling
R407C	+4°C dew point	+38°C bubble point +43°C dew point	1K
R134a, R404A, R507	+4°C	+38°C	1K

Spare Parts

Description	Type	Part No.
Gasket Set for 935 Series Valves	X 13455 -1	027 579
Service Tool for 935 Series Valves	X 99999	800 005
Steel screws for following flange types: C501, 9761, 6346, A576 9148, 9149, 9152, 9153, 10331, 10332	Screw ST 32 Screw ST 48	803 573 803 574
Bronze screws for following flange types: C501, 9761, 6346, A576 9148, 9149, 9152, 9153, 10331, 10332	Screw BZ 32 Screw BZ 48	803 575 803 576

Correction Tables for Series 935

Valve selection for operating conditions other than nominal conditions:

$$Q_n = Q_o \times K_t \times \Delta p$$

Q_n : Nominal valve capacity

Q_o : Required cooling or desuperheating capacity

K_t : Correction factor for evaporating and liquid temperature

Δp : Correction factor for pressure drop at valve

Liquid Temperature entering Valve °C	R134a				Correction Factor k_t Evaporating Temperature (°C)											
	+30	+25	+20	+15	+10	+5	0	-5	-10	-15	-20	-25	-30			
+60	1.22	1.25	1.27	1.30	1.33	1.36	1.40	1.44	1.48	1.51	1.56	1.61	1.67			
+55	1.14	1.16	1.18	1.21	1.23	1.26	1.29	1.33	1.36	1.39	1.43	1.47	1.52			
+50	1.07	1.08	1.10	1.13	1.15	1.17	1.20	1.23	1.26	1.28	1.32	1.36	1.39			
+45	1.00	1.02	1.04	1.06	1.08	1.10	1.12	1.15	1.17	1.19	1.22	1.26	1.29			
+40	0.93	0.96	0.98	0.99	1.01	1.03	1.05	1.08	1.10	1.12	1.14	1.17	1.20			
+35	0.90	0.91	0.92	0.94	0.96	0.97	0.99	1.01	1.03	1.05	1.07	1.10	1.12			
+30	0.85	0.86	0.88	0.89	0.91	0.92	0.94	0.96	0.98	0.99	1.01	1.03	1.06			
+25		0.82	0.83	0.85	0.86	0.87	0.89	0.91	0.92	0.94	0.95	0.97	1.00			
+20			0.80	0.81	0.82	0.83	0.85	0.89	0.88	0.89	0.91	0.92	0.94			
+15				0.77	0.78	0.79	0.81	0.82	0.84	0.84	0.86	0.88	0.89			
+10					0.75	0.76	0.77	0.78	0.80	0.81	0.82	0.84	0.85			
+5						0.73	0.74	0.75	0.76	0.77	0.78	0.80	0.81			
0							0.71	0.72	0.73	0.74	0.75	0.76	0.78			
-5								0.69	0.70	0.71	0.72	0.73	0.74			
-10									0.68	0.68	0.69	0.70	0.71			
Correction Factor $k_{\Delta p}$																
Δp (bar)	0.5	1.0	1.5	2.0	2.5	3.0	3.5	4.0	4.5	5.0	5.5	6.0	6.5	7.0	7.5	8.0
$K_{\Delta p}$	3.50	2.48	2.02	1.75	1.57	1.43	1.32	1.24	1.17	1.11	1.06	1.01	0.97	0.94	0.90	0.88
Δp (bar)	8.5	9.0	9.5	10.0	10.5	11.0	11.5	12.0	13.0	14.0	15.0	16.0	17.0	18.0	19.0	20.0
$K_{\Delta p}$	0.85	0.83	0.80	0.78	0.76	0.75	0.73	0.72	0.69	0.66	0.64	0.62	0.60	0.58	0.57	0.55

Liquid Temperature entering Valve °C	R404A				Correction Factor kt Evaporating Temperature (°C)											
	+30	+25	+20	+15	+10	+5	0	-5	-10	-15	-20	-25	-30	-35	-40	-45
+60	1.56	1.59	1.64	1.69	1.74	1.81	1.88	1.96	2.06	2.16	2.28	2.42	2.57	2.75	2.95	3.19
+55	1.32	1.35	1.38	1.42	1.46	1.50	1.55	1.61	1.68	1.75	1.83	1.92	2.01	2.13	2.25	2.39
+50	1.16	1.18	1.20	1.23	1.26	1.30	1.34	1.38	1.43	1.48	1.54	1.61	1.68	1.75	1.84	1.94
+45	1.04	1.05	1.07	1.10	1.12	1.15	1.18	1.22	1.26	1.30	1.34	1.39	1.45	1.51	1.57	1.64
+40	0.94	0.96	0.97	0.99	1.02	1.04	1.07	1.09	1.13	1.16	1.20	1.24	1.28	1.33	1.38	1.43
+35	0.87	0.88	0.90	0.91	0.93	0.95	0.97	1.00	1.02	1.05	1.08	1.11	1.15	1.19	1.23	1.27
+30	0.81	0.82	0.83	0.84	0.86	0.88	0.90	0.92	0.94	0.96	0.99	1.02	1.05	1.08	1.11	1.15
+25		0.76	0.77	0.79	0.80	0.82	0.83	0.85	0.87	0.89	0.92	0.94	0.97	0.99	1.02	1.05
+20			0.73	0.74	0.75	0.77	0.78	0.80	0.81	0.83	0.85	0.87	0.90	0.92	0.95	0.97
+15				0.70	0.71	0.72	0.73	0.75	0.76	0.78	0.80	0.82	0.84	0.86	0.88	0.90
+10					0.67	0.68	0.69	0.71	0.72	0.74	0.75	0.77	0.79	0.81	0.83	0.85
+5						0.65	0.66	0.67	0.68	0.70	0.71	0.73	0.74	0.76	0.78	0.80
0							0.63	0.64	0.65	0.66	0.68	0.69	0.71	0.72	0.74	0.75
-5								0.61	0.62	0.63	0.65	0.66	0.67	0.69	0.70	0.72
-10									0.60	0.61	0.62	0.63	0.64	0.65	0.67	0.68
Correction Factor kΔp																
Δp (bar)	0.5	1.0	1.5	2.0	2.5	3.0	3.5	4.0	4.5	5.0	5.5	6.0	6.5	7.0	8.0	9.0
KΔp	4.55	3.21	2.62	2.27	2.03	1.86	1.72	1.61	1.52	1.44	1.37	1.31	1.26	1.21	1.14	1.07
Δp (bar)	10.0	11.0	12.0	13.0	14.0	15.0	16.0	17.0	18.0	19.0	20.0	21.0	22.0	23.0	24.0	25.0
KΔp	1.02	0.97	0.93	0.89	0.86	0.83	0.80	0.78	0.76	0.74	0.72	0.70	0.69	0.67	0.66	0.64

Liquid Temperature entering Valve °C	R407C				Correction Factor kt Evaporating Temperature (°C)											
	+30	+25	+20	+15	+10	+5	0	-5	-10	-15	-20	-25				
+55	1.20	1.21	1.23	1.26	1.28	1.31	1.34	1.37	1.40	1.44	1.48	1.52				
+50	1.10	1.11	1.13	1.15	1.17	1.19	1.22	1.24	1.27	1.30	1.33	1.37				
+45	1.02	1.03	1.05	1.06	1.08	1.10	1.12	1.14	1.17	1.19	1.22	1.25				
+40	0.95	0.96	0.98	0.99	1.01	1.02	1.04	1.06	1.08	1.11	1.13	1.16				
+35	0.89	0.90	0.92	0.93	0.94	0.96	0.98	0.99	1.01	1.03	1.05	1.07				
+30	0.85	0.85	0.87	0.88	0.89	0.90	0.92	0.93	0.95	0.97	0.99	1.01				
+25		0.81	0.82	0.83	0.84	0.85	0.87	0.88	0.90	0.91	0.93	0.95				
+20			0.78	0.79	0.80	0.81	0.82	0.84	0.85	0.86	0.88	0.90				
+15				0.75	0.76	0.77	0.78	0.80	0.81	0.82	0.84	0.85				
+10					0.73	0.74	0.75	0.76	0.77	0.78	0.80	0.81				
+5						0.71	0.72	0.73	0.74	0.75	0.76	0.77				
0							0.69	0.70	0.71	0.72	0.73	0.74				
-5								0.67	0.68	0.69	0.70	0.71				
-10									0.65	0.66	0.67	0.68				
Correction Factor kΔp																
Δp (bar)	0.5	1.0	1.5	2.0	2.5	3.0	3.5	4.0	4.5	5.0	5.5	6.0	6.5	7.0	8.0	9.0
KΔp	4.78	3.33	2.72	2.36	2.11	1.92	1.78	1.67	1.57	1.49	1.42	1.36	1.31	1.26	1.18	1.11
Δp (bar)	10.0	11.0	12.0	13.0	14.0	15.0	16.0	17.0	18.0	19.0	20.0	21.0	22.0	23.0	24.0	25.0
KΔp	1.05	1.01	0.96	0.92	0.89	0.86	0.83	0.81	0.79	0.76	0.75	0.73	0.71	0.70	0.68	0.67

Note: See beginning of this chapter for determining of conditions for systems with R407C.

Liquid Temperature entering Valve °C	R507				Correction Factor kt Evaporating Temperature (°C)											
	+30	+25	+20	+15	+10	+5	0	-5	-10	-15	-20	-25	-30	-35	-40	-45
+60	1.54	1.57	1.61	1.65	1.71	1.76	1.83	1.90	1.98	2.08	2.18	2.30	2.43	2.58	2.75	2.95
+55	1.30	1.33	1.36	1.39	1.43	1.47	1.52	1.57	1.62	1.69	1.76	1.83	1.92	2.02	2.12	2.25
+50	1.15	1.17	1.19	1.22	1.24	1.28	1.31	1.35	1.40	1.44	1.49	1.55	1.61	1.68	1.76	1.84
+45	1.03	1.05	1.07	1.09	1.11	1.14	1.17	1.20	1.23	1.27	1.31	1.36	1.40	1.46	1.52	1.58
+40	0.94	0.96	0.97	0.99	1.01	1.03	1.06	1.08	1.11	1.14	1.17	1.21	1.25	1.29	1.34	1.39
+35	0.87	0.88	0.90	0.91	0.93	0.95	0.97	0.99	1.01	1.04	1.07	1.10	1.13	1.16	1.20	1.24
+30	0.81	0.82	0.83	0.85	0.86	0.88	0.89	0.91	0.93	0.96	0.98	1.01	1.03	1.06	1.09	1.13
+25		0.77	0.78	0.79	0.80	0.82	0.83	0.85	0.87	0.89	0.91	0.93	0.95	0.98	1.01	1.03
+20			0.73	0.74	0.75	0.77	0.78	0.79	0.81	0.83	0.85	0.87	0.89	0.91	0.93	0.96
+15				0.70	0.71	0.72	0.73	0.75	0.76	0.78	0.79	0.81	0.83	0.85	0.87	0.89
+10					0.67	0.68	0.69	0.70	0.72	0.73	0.74	0.76	0.78	0.79	0.81	0.83
+5						0.64	0.65	0.67	0.68	0.69	0.70	0.72	0.73	0.75	0.76	0.78
0							0.62	0.63	0.64	0.65	0.66	0.68	0.69	0.70	0.72	0.73
-5								0.60	0.61	0.62	0.63	0.64	0.65	0.66	0.68	0.69
-10									0.58	0.59	0.60	0.61	0.62	0.63	0.64	0.65
Correction Factor kΔp																
Δp (bar)	0.5	1.0	1.5	2.0	2.5	3.0	3.5	4.0	4.5	5.0	5.5	6.0	6.5	7.0	8.0	9.0
KΔp	4.63	3.27	2.67	2.31	2.07	1.89	1.75	1.64	1.54	1.46	1.40	1.34	1.28	1.24	1.16	1.09
Δp (bar)	10.0	11.0	12.0	13.0	14.0	15.0	16.0	17.0	18.0	19.0	20.0	21.0	22.0	23.0	24.0	25.0
KΔp	1.03	0.99	0.94	0.91	0.87	0.85	0.82	0.79	0.77	0.75	0.73	0.71	0.70	0.68	0.67	0.65

Flanges for Valves

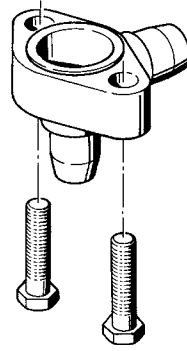

Angle Style Flange
(WL)

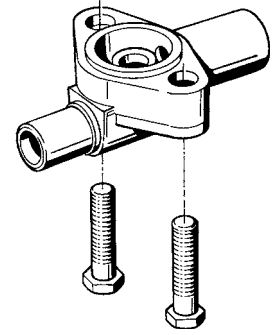

Straight Through Flange
(DL)

Flanges: T- / L-Series							
Valve series	Orifice type	Angle style		Straight through		Connection (inlet x outlet)	
		Type	Part No.	Type	Part No.	Metric	Imperial
TCLE / LCLE	X22440-B1B / B2B / B3B / B3.5B / B4B	C501-5	803232	9761-3	803240	-	3/8"x5/8" ODF
		C501-5mm	803233	9761-3mm	803241	10x16mm ODF	
	X22440-B5B / B6B	C501-7	803234	9761-4	803350		1/2"x5/8" ODF
		C501-7mm	803235	9761-4mm	803243	12x16mm ODF	-
	X22440-B7B / B8B	-	-	6346-17	803330	16x22mm ODF	5/8"x7/8" ODF
		A576	803238	-	-	-	5/8"x7/8" ODF
A576-mm		803239	-	-	16x22mm ODF 22x28mm ODM	-	
TJRE / LJRE	X11873-B4B / B5B	10331	803338	10332	803324	22x22mm ODF	7/8"x7/8" ODF 1-1/8"x1-1/8" ODM
TERE/ TIRE	X9117-B6B / B7B / B8B / B9B / B10B	9153	803244	9152	803286	-	7/8"x7/8" ODF 1-1/8"x1-1/8" ODM
LERE/ LIRE		9153-mm	803245	9152-mm	803287	22x22mm ODF 22x28mm ODM	
THRE	X9144-B11B / B13B	9149	803284	9148	803283	22x22mm ODF	7/8"x7/8" ODF 1-1/8"x1-1/8" ODM

Flanges: 935- / ZZ-Series							
Valve series	Orifice type	Angle style		Straight through		Connection (inlet x outlet)	
		Type	Part No.	Type	Part No.	Metric	Imperial
935 / ZZ	X10-*01 / *02 / *03	C501-5	803232	9761-3	803240	-	3/8"x5/8" ODF
		C501-5mm	803233	9761-3mm	803241	10x16mm ODF	
	X10-*04 / *05	C501-7	803234	9761-4	803350		1/2"x5/8" ODF
		C501-7mm	803235	9761-4mm	803243	12x16mm ODF	-
	X10-*06 / *07	-	-	6346-17	803330	16x22mm ODF	5/8"x7/8" ODF
		A576	803238	-	-	-	5/8"x7/8" ODF
A576-mm		803239	-	-	16x22mm ODF 22x28mm ODM	-	

Solenoid Valves

Solenoid Valves

Basic Terms and Technical Information

Operating principles

Directly actuated: The magnetic field of the solenoid coil forces a movement of the plunger and thus causes the opening of the valve seat.

Servo actuated: The magnetic field of the solenoid coil is only utilized for the opening of the pilot valve seat. The necessary energy to actuate the piston or diaphragm of the main valve seat is provided by the refrigerant flow and results in a certain pressure drop.

Minimum Pressure Drop

Directly actuated solenoid valves do not require a minimum pressure drop for proper operation.

Servo operated solenoid valves require a minimum pressure drop of approximately 0.05 bar to remain fully open. In case of insufficient refrigerant flow, this value will not be reached and the solenoid valve may close unintentionally. These closures may lead to malfunctions and oscillations in the refrigeration circuit. Improper sizing of solenoid valves (i.e., use of excessively large solenoid valves) is the main cause of this effect. This is particularly important in capacity controlled refrigeration circuits.

Therefore the decisive factor for proper solenoid valve sizing is the respective capacity of the valve and not its connection size.

Formula for calculating the actual pressure drop of a solenoid valve:

$$\Delta_{p1} = \Delta_{p2} \times (Q_{n1}/Q_{n2})^2$$

- Δ_{p1} : Actual pressure drop
- Δ_{p2} : Nominal pressure drop at Q_{n1}
- Q_{n1} : Calculated nominal capacity
- Q_{n2} : Nominal capacity of selected valve

Maximum Operating Pressure Differential (MOPD)

MOPD is the maximum pressure differential between inlet and outlet of the solenoid valve which permits proper opening of the valve. When used with Alco AC solenoid coils all Alco solenoid valves employ 25 bar MOPD.

Operation in conjunction with DC solenoid coils lead to reduced MOPD values depending on valve type and size. The **DS2 Chopper Plugs** allow the use of 24VAC coils with 24VDC by converting the DC in an AC voltage. Please contact Emerson Climate Technologies application engineering for additional details.

Selection Guide for Solenoid Valves

Selection Criteria	Series						
	110 RB	200 RB / 200 RH	240 RA		540 RA		M36
			8/9/12/16T9	16T11/20	8/9/12/16	20	
2-Way	+	+	+	+	+	+	
3-Way							+
Normally Closed (NC)	+	+	+	+			
Normally Open (NO)					+	+	
Min. Pressure Differential (bar)	0.00	0.05	0.05	0.05	0.05	0.05	
MWP (bar)	31	31 / 60 (50)	31	31	31	28	35
Media Temp. Range (°C)	-40 / +120	-40 / +120	-40 / +120	-40 / +120	-40 / +120	-40 / +120	-40 / +120
Coil Type	ASC3	ASC3	ASC3	ASC3	ASC3	ASC3	ASC3

Type Code

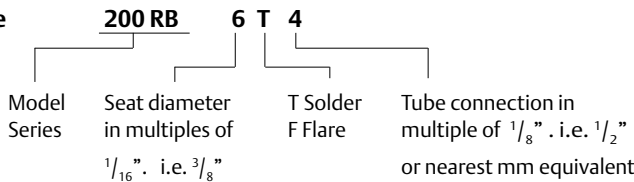

Coils ASC3 and Cable Assemblies

Standards

- ASC3 Coils and cable assemblies conform to Low Voltage Directive



ASC3

Type	Part No.	Voltage	Power Input	Electr. Connection	Protection
ASC3 230V / 50 (60) Hz	801 077	AC	8 W	without plug see cable assemblies	IP65 with plug / cable assembly
ASC3 120V / 50 (60) Hz	801 078				
ASC3 24V / 50 (60) Hz	801 079				
ASC3 24V DC	801 076	DC	17 W		
DS2-N15 + ASC3 24VAC	804 620 + 801 079	DC	3 W	with plug and cable assembly	IP65

Note: Coils are delivered with retainer kit.
Please order cable assemblies separately.



ASC-N15

Cable Assemblies for ASC Coils

Type	Part No.	Temperature Range	Cable length	Wire diameter	Connector Type
ASC-N15	804 570	-50 .. +80°C for stationary use only	1.5m	3 x 0.75 mm ²	loose wires
ASC-N30	804 571		3.0m		
ASC-N60	804 572		6.0m		



DS2-N15 ASC3 24V

Cable Assembly with 24V DC Chopper Plug

- Enables standard 24V AC Coil to be used for DC applications
- Low power assumption (3W only)
- No MOPD degradation

Type	Part No.	Temperature Range	Cable length	Wire diameter	Connector Type
DS2-N15	804 620	-25 .. +80°C	1.5 m	2 x 0.75 mm ²	loose wires

Other Accessories for Solenoid Valves

Type	Part No.	Description
X 11981-1	027 451	Service tool for 110RB. 240RA. 540RA. 3031
ASC3-K01	801 080	Retainer kit (one cap + two O-rings)
PG9 Plug	801 012	Plug according to EN 175301 with cable gland PG 9
PG11 Plug	801 013	Plug according to EN 175301 with cable gland PG 11

2-Way Solenoid Valves Series 110, 200, 240

Normally Closed

Features

- Compact size
- No disassembly necessary for soldering

Standards

- 240 RA 16T11 and 20 are CE marked per PED

Accessories:

- Actuation coil and cable assemblies available for various voltages, see 'Coils ASC3 and Cable Assemblies'



Capacity Data

Type	Nominal Capacity Q _n (kW)													kv-value m ³ /h	Δp min bar
	Liquid					Hot Gas				Suction Gas					
	R134a	R22	R404A R507	R407C	R407F	R134a	R22	R404A R507	R407C	R134a	R22	R507	R407C		
110 RB 2	3.5	3.8	2.5	3.6	4.2	1.6	2.0	1.7	2.1					0.2	0
200 RB 3	6.6	7.1	4.6	6.8	7.9	3.0	3.7	3.2	3.9					0.4	0.05
200 RB 4	15.5	16.8	10.9	16.1	18.8	7.1	8.8	7.5	9.2					0.9	0.05
200 RB 6	27.3	29.5	18.9	28.0	33.0	12.5	15.4	13.1	16.1					1.6	0.05
240 RA 8	36.3	39.3	25.2	37.3	43.9	16.7	20.5	17.4	21.4	4.2	5.6	4.6	5.2	2.3	0.05
240 RA 9	76.2	82.5	52.9	78.4	92.2	35.1	43.1	36.5	44.9	8.8	11.7	9.7	10.9	4.8	0.05
240 RA 12	85.7	92.8	59.5	88.1	103.7	39.4	48.4	41.1	50.5	9.9	13.1	10.9	12.3	5.4	0.05
240 RA 16	139.1	150.5	96.5	142.9	168.2	64.0	78.5	66.6	81.9	16.0	21.3	17.7	19.9	8.8	0.05
240 RA 20	202.6	219.3	140.7	208.3	245.2	93.2	114.4	97.1	119.3	33.0	31.0	25.7	29.0	12.8	0.05

Nominal capacities at +38°C condensing temperature, +4°C evaporating temperature, subcooling 1 K. 0.15 bar pressure drop between valve inlet and outlet in liquid applications. 1 bar pressure drop for hot gas applications. +18 °C suction gas temperature.

Selection Guide

Type	Part No.	Connection Solder / ODF	
		mm	Inch
110 RB 2	T2	801 217	6
	T2	801 210	¼
	T3	801 209	10
200 RB 3	T3	801 239	10
200 RB 4	T3	801 176	10
	T3	801 190	⅜
	T4	801 178	12
	T4	801 179	½
200 RB 6	T4	801 182	12
	T4	801 183	½
	T5	801 186	16
240 RA 8	T5	801 160	⅝
	T7	801 143	⅞
240 RA 9	T5	801 161	⅝
	T7	801 162	⅞
	T9	801 142	1-⅛
240 RA 12	T7	801 163	⅞
	T9	801 144	1-⅛
240 RA 16	T9	801 164	1-⅛
	T11	801 166	1-⅝
240 RA 20	T11-M	801 172	1-⅝
	T13-M	801 224	
	T13-M	801 173	1-⅝
	T17-M	801 174	2-⅛

Special Versions:

- Manual stems (Type M) available upon request for selected types of Series 240 RA 8 to 240 RA 16.
- Manual stems standard on Series 240 RA 20.

Options:

- Actuation coils available for various voltages, see 'Coils ASC3 and Cable Assemblies'

2-Way Solenoid Valves Series 540

Normally Open

Features

- Compact size
- No disassembly necessary for soldering



540 RA

Accessories:

- Actuation coil and cable assemblies available for various voltages, see 'Coils ASC3 and Cable Assemblies'

Capacity Data

Type	Nominal Capacity Q _n (kW)												kv-value m ³ /h	Δp min bar
	Liquid				Hot Gas				Suction Gas					
	R134a	R22	R404A R507	R407C	R134a	R22	R404A R507	R407C	R134a	R22	R507	R407C		
540 RA 8	36.3	39.3	25.2	37.3	16.7	20.5	17.4	21.4	4.2	5.6	4.6	5.2	2.3	0.05
540 RA 9	76.2	82.5	52.9	78.4	35.1	43.1	36.5	44.9	8.8	11.7	9.7	10.9	4.8	0.05
540 RA 12	85.7	92.8	59.5	88.1	39.4	48.4	41.1	50.5	9.9	13.1	10.9	12.3	5.4	0.05
540 RA 16	139.1	150.5	96.5	142.9	64.0	78.5	66.6	81.9	16.0	21.3	17.7	19.9	8.8	0.05
540 RA 20	202.6	219.3	140.7	208.3	93.2	114.4	97.1	119.3	23.3	31.0	25.7	29.0	12.8	0.05

Nominal capacities at +38°C condensing temperature. +4°C evaporating temperature. 0.15 bar pressure drop between valve inlet and outlet in liquid applications (for hot gas applications 1 bar pressure drop and +18°C suction gas temperature); subcooling 1 K. Correction tables for other operating conditions see Correction Tables for 110 RB, 20 RB, 240 RA and 540 RA.

Selection Guide

Type	Part No.	Connection Solder / ODF	
		mm	Inch
540 RA 8	T5	046 265	5/8
540 RA 9	T5	046 266	5/8
	T7	046 268	7/8
540 RA 12	T7	046 269	7/8
540 RA 16	T9	046 270	1-1/8
540 RA 20	T11	047 953	1-3/8

Options:

- Actuation coils available for various voltages, see 'Coils ASC3 and Cable Assemblies'

Accessories and spare parts for solenoid valves

Description	Type	Part No.
Service tool for 110 RB, 240 RA, 540 RA	X 11981 - 1	027 451
Gasket kits		
110RB	KS 30040-2	801 232
200RB	KS 30039-1	801 233
240RA8	KS 30061-1	801 234
240RA9/12	KS 30062-1	801 235
240RA16	KS 30065-1	801 236
240RA20	KS 30097-1	801 237

Description	Type	Part No.
110RB	KS 30040-1	801 206
200RB	KS 30039/ KS 30109	801 205
240RA8	KS 30061	801 262
240RA9	KS 30062	801 263
240RA12	KS 30063	801 264
240RA16	KS 30065	801 200
240RA20	KS 30097	801 216

2-Way Solenoid Valves Series 200 RH for high pressure applications

Normally Closed

Features

- Compact size
- Media Temperature Range -40 to +120 °C
- No disassembly necessary for soldering
- Extended copper tubes for easy installation
- No disassembly necessary for brazing
- IP 65 Solenoid coil and cable assembly
- One coil fits to all sizes and valve series

Accessories:

- Actuation coil and cable assemblies available for various voltages, see 'Coils ASC3 and Cable Assemblies'



Capacity Data

Type	Nominal Capacity Q _n (kW)			
	Liquid		Hot Gas	
	R410A	R744	R410A	R744
200 RH 3	19.6	27.5	4.7	6.9
200 RH 4	34.4	48.3	10.5	15.5
200 RH 6	45.9	64.4	18.7	27.6

R410A: Nominal capacities at +38°C condensing temperature, +4°C evaporating temperature, subcooling 1 K
0.15 bar pressure drop between valve inlet and outlet in liquid applications.
1 bar pressure drop for hot gas applications

R744: Nominal capacities at +10°C condensing temperature, -10°C evaporating temperature, subcooling 1 K
0.15 bar pressure drop between valve inlet and outlet in liquid applications.
1 bar pressure drop for hot gas applications

Selection Guide

Type		Part No.	Connection Solder / ODF	
			mm	inch
200 RH 3	T3	802 070	10 mm	3/8"
	T3	802 071	10 mm	
200 RH 4	T3	802 072		3/8"
	T4	802 073	12 mm	
	T4	802 074		1/2"
200 RH 6	T4	802 075	12 mm	
	T4	802 076		1/2"
	T5	802 077	16 mm	5/8"

Options:

- Actuation coils available for various voltages, see '2-Way Solenoid Valves coils ASC3'

Correction Tables for 110 RB, 200 RB, 240 RA and 540 RA Series

Valve selection for operating conditions other than nominal:

$$Q_n = Q_o \times K_t \times K_{\Delta P}$$

- Q_n : Nominal valve capacity
- K_t : Correction factor for evaporating and liquid temperature
- $K_{\Delta P}$: Correction factor for pressure drop at valve
- Q_o : Required cooling capacity

The pressure drop can be calculated with the following formula:

$$\Delta P_o = \Delta P_n \times \frac{Q_o^2}{Q_n^2}$$

$$\Delta P_n = 0.15 \text{ bar}$$

ΔP_n : Pressure drop under nominal conditions

1. Suction Gas Application

Evaporating Temperature °C	Correction Factor kt										
	Condensing Temperature (°C)										
	+60	+55	+50	+45	+40	+35	+30	+25	+20		
+10	1.03	0.97	0.92	0.88	0.84	0.80	0.76	0.74	0.71		
0	1.40	1.32	1.25	1.20	1.14	1.10	1.04	1.01	0.96		
-10	1.71	1.62	1.53	1.47	1.40	1.34	1.27	1.23	1.18		
-20	2.20	2.08	1.97	1.88	1.80	1.72	1.64	1.58	1.51		
-30	2.79	2.63	2.50	2.39	2.27	2.19	2.07	2.01	1.92		
-40	3.68	3.47	3.29	3.15	3.00	2.89	2.73	2.65	2.53		
Correction Factor kΔp											
Δp (bar)	0.05	0.10	0.15	0.20	0.25	0.30	0.35	0.40	0.45	0.50	0.55
KΔp	1.73	1.22	1.00	0.87	0.77	0.71	0.65	0.61	0.48	0.55	0.52

2. Liquid Application

Liquid Temperature entering valve °C	Correction Factor kt / Evaporating Temperature (°C)														
	R134a							R22							
	+10	0	-10	-20	-30			+10	0	-10	-20	-30	-40		
+60	1.33	1.40	1.48	1.56	1.67			1.26	1.30	1.38	1.38	1.44	1.50		
+55	1.23	1.29	1.36	1.43	1.52			1.19	1.22	1.29	1.29	1.34	1.39		
+50	1.15	1.20	1.26	1.32	1.39			1.12	1.15	1.21	1.22	1.26	1.30		
+45	1.08	1.12	1.17	1.22	1.29			1.06	1.08	1.15	1.15	1.18	1.23		
+40	1.01	1.05	1.10	1.14	1.20			1.01	1.03	1.09	1.09	1.12	1.16		
+35	0.96	0.99	1.03	1.07	1.12			0.96	0.98	1.03	1.03	1.06	1.10		
+30	0.91	0.94	0.98	1.01	1.06			0.92	0.94	0.99	0.98	1.01	1.04		
+25	0.86	0.89	0.92	0.95	1.00			0.88	0.89	0.94	0.94	0.96	0.99		
+20	0.82	0.85	0.88	0.91	0.94			0.84	0.86	0.90	0.90	0.92	0.95		
+15	0.78	0.81	0.84	0.86	0.89			0.81	0.82	0.87	0.86	0.88	0.91		
+10	0.75	0.77	0.80	0.82	0.85			0.78	0.79	0.83	0.83	0.85	0.87		
+5		0.74	0.76	0.78	0.81				0.76	0.80	0.79	0.81	0.83		
0		0.71	0.73	0.75	0.78				0.73	0.77	0.77	0.78	0.80		
-5			0.70	0.72	0.74					0.74	0.74	0.75	0.77		
-10			0.68	0.69	0.71					0.72	0.71	0.73	0.74		
Correction Factor kΔp															
Δp (bar)	0.05	0.10	0.15	0.20	0.25	0.30	0.35	0.40	0.45	0.50	0.55	0.60	0.65	0.70	0.75
KΔp	1.73	1.22	1.00	0.87	0.77	0.71	0.65	0.61	0.58	0.55	0.52	0.50	0.48	0.46	0.45

2. Liquid Application (continued)

Liquid Temperature entering valve °C	Correction Factor kt / Evaporating Temperature (°C)														
	R404A							R507							
	+10	0	-10	-20	-30	-40			+10	0	-10	-20	-30	-40	
+60	1.74	1.88	2.06	2.28	2.57	2.95			1.71	1.83	1.98	2.18	2.43	2.75	
+55	1.46	1.55	1.68	1.83	2.01	2.25			1.43	1.52	1.62	1.76	1.92	2.12	
+50	1.26	1.34	1.43	1.54	1.68	1.84			1.24	1.31	1.40	1.49	1.61	1.76	
+45	1.12	1.18	1.26	1.34	1.45	1.57			1.11	1.17	1.23	1.31	1.40	1.52	
+40	1.02	1.07	1.13	1.20	1.28	1.38			1.01	1.06	1.11	1.17	1.25	1.34	
+35	0.93	0.97	1.02	1.08	1.15	1.23			0.93	0.97	1.01	1.07	1.13	1.20	
+30	0.86	0.90	0.94	0.99	1.05	1.11			0.86	0.89	0.93	0.98	1.03	1.09	
+25	0.80	0.83	0.87	0.92	0.97	1.02			0.80	0.83	0.87	0.91	0.95	1.01	
+20	0.75	0.78	0.81	0.85	0.90	0.95			0.75	0.78	0.81	0.85	0.89	0.93	
+15	0.71	0.73	0.76	0.80	0.84	0.88			0.71	0.73	0.76	0.79	0.83	0.87	
+10	0.67	0.69	0.72	0.75	0.79	0.83			0.67	0.69	0.72	0.74	0.78	0.81	
+5		0.66	0.68	0.71	0.74	0.78				0.65	0.68	0.70	0.73	0.76	
0		0.63	0.65	0.68	0.71	0.74				0.62	0.64	0.66	0.69	0.72	
-5			0.62	0.65	0.67	0.70					0.61	0.63	0.65	0.68	
-10			0.60	0.62	0.64	0.67					0.58	0.60	0.62	0.64	
Liquid Temperature entering valve °C	Correction Factor kt / Evaporating Temperature (°C)														
	R407C														
	+10	0	-10	-20											
+60															
+55	1.28	1.34	1.40	1.48											
+50	1.17	1.22	1.27	1.33											
+45	1.08	1.12	1.17	1.22											
+40	1.01	1.04	1.08	1.13											
+35	0.94	0.98	1.01	1.05											
+30	0.89	0.92	0.95	0.99											
+25	0.84	0.87	0.90	0.93											
+20	0.80	0.82	0.85	0.88											
+15	0.76	0.78	0.81	0.84											
+10	0.73	0.75	0.77	0.80											
+5		0.72	0.74	0.76											
0		0.69	0.71	0.73											
-5			0.68	0.70											
-10			0.65	0.67											
Correction Factor kΔp															
Δp (bar)	0.05	0.10	0.15	0.20	0.25	0.30	0.35	0.40	0.45	0.50	0.55	0.60	0.65	0.70	0.75
KΔp	1.73	1.22	1.00	0.87	0.77	0.71	0.65	0.61	0.58	0.55	0.52	0.50	0.48	0.46	0.45

2. Liquid Application (continued)

Liquid Temperature entering Valve °C	R407F Correction factors for solenoid valves Evaporating temperature °C													
	+20	+15	+10	+5	0	-5	-10	-15	-20	-25	-30	-35	-40	-45
+65	1.51	1.53	1.55	1.58	1.61	1.64	1.68	1.71	1.75	1.80	1.85	1.90	1.96	2.02
+60	1.35	1.37	1.39	1.41	1.43	1.46	1.49	1.52	1.55	1.59	1.63	1.67	1.71	1.76
+55	1.23	1.25	1.26	1.28	1.30	1.32	1.35	1.37	1.40	1.43	1.46	1.50	1.53	1.57
+50	1.14	1.15	1.16	1.18	1.20	1.22	1.24	1.26	1.28	1.31	1.33	1.36	1.39	1.43
+45	1.06	1.07	1.08	1.10	1.11	1.13	1.14	1.16	1.18	1.20	1.23	1.25	1.28	1.31
+40	0.99	1.00	1.01	1.02	1.04	1.05	1.07	1.08	1.10	1.12	1.14	1.16	1.18	1.21
+35	0.93	0.94	0.95	0.96	0.97	0.99	1.00	1.01	1.03	1.05	1.06	1.08	1.10	1.13
+30	0.88	0.89	0.90	0.91	0.92	0.93	0.94	0.95	0.97	0.98	1.00	1.02	1.03	1.05
+25	0.83	0.84	0.85	0.86	0.87	0.88	0.89	0.90	0.91	0.93	0.94	0.96	0.97	0.99
+20	0.79	0.80	0.81	0.82	0.82	0.83	0.84	0.85	0.87	0.88	0.89	0.91	0.92	0.94
+15	0.76	0.76	0.77	0.78	0.78	0.79	0.80	0.81	0.82	0.83	0.85	0.86	0.87	0.89
+10	0.72	0.73	0.74	0.74	0.75	0.76	0.77	0.77	0.78	0.79	0.81	0.82	0.83	0.84
+5	0.69	0.70	0.70	0.71	0.72	0.72	0.73	0.74	0.75	0.76	0.77	0.78	0.79	0.80
0	0.66	0.67	0.68	0.68	0.69	0.69	0.70	0.71	0.72	0.73	0.73	0.74	0.75	0.77
-5	0.64	0.64	0.65	0.65	0.66	0.67	0.67	0.68	0.69	0.70	0.70	0.71	0.72	0.73
-10	0.62	0.62	0.62	0.63	0.63	0.64	0.65	0.65	0.66	0.67	0.68	0.68	0.69	0.70
Correction Factor $k_{\Delta P}$														
ΔP (bar)	0.05	0.1	0.15	0.2	0.25	0.3	0.35	0.4	0.45	0.55	0.6	0.65	0.7	0.75
$k_{\Delta P}$	1.73	1.22	1	0.87	0.77	0.71	0.65	0.61	0.58	0.52	0.5	0.48	0.46	0.45

3. Hot Gas Application

Correction Factor k_t Evaporating Temperature (°C)											
	+10	+5	0	-5	-10	-15	-20	-25	-30	-35	-40
k_t	0.96	1.00	1.03	1.06	1.10	1.13	1.17	1.20	1.24	1.29	1.33
Correction Factor $k_{\Delta P}$											
Δp (bar)	0.35	0.50	0.70	1.00	1.50	2.00	2.50	3.00	4.00		
$K_{\Delta p}$	1.72	1.49	1.22	1.00	0.86	0.78	0.73	0.70	0.65		

3-Way Solenoid Valves Series M36

Features

- For heat reclaim application
- Pilot connection to suction line required. no minimum pressure drop
- Compact size
- No disassembly necessary for brazing
- Max. allowable pressure PS: 35 bar

Accessories:

- Actuation coil and cable assemblies available for various voltages, see 'Coils ASC3 and Cable Assemblies'



M36-118



M36-078 with ASC3 Coil and DS2 Chopper Plug

Capacity Data

Type	Part No.	Connection Solder/ODF		Nominal Capacity Q _n (kW)				kv-Value m ³ /h	Coil Type
		mm	inch	R134a	R22	R404A / R507	R407C		
M36-078	801 420	22	7/8	28.9	35.1	31.3	38.5	6.7	ASC3
M36-118	801 421		1-1/8						

Nominal capacities at +38°C condensing temperature. +4°C evaporating temperature (saturated pressures / dew point). 0.15 bar pressure drop between valve inlet and outlet.

Q_o: Required cooling capacity

K_t: Correction factor for evaporating and liquid temperature

K_{Δp}: Correction factor for pressure drop at valve

Q_n: Nominal valve capacity

For other operating conditions multiply required capacity Q_o with correction factors K_t and K_{Δp}.

$$Q_o \times K_t \times K_{\Delta p} = Q_n$$

Correction Tables

Correction Factor K _t Evaporating Temperature (°C)											
	+10	+5	0	-5	-10	-15	-20	-25	-30	-35	-40
K _t	0.96	1.00	1.03	1.06	1.10	1.13	1.17	1.20	1.24	1.29	1.33
Correction Factor K _{Δp} Pressure drop across Valve (bar)											
	0.10	0.14	0.20	0.30	0.40	0.50	0.60	0.70	0.80	0.90	1.00
K _{Δp}	1.22	1.00	0.87	0.71	0.61	0.55	0.50	0.46	0.43	0.41	0.39

Accessories and spare parts for series M36

Description	Part No.
Repair Kit for M36-UNF (O-Ring Gasket & pilot assembly)	801 440

Conversion Table 3031 Series to M36

3031 Series has been replaced by M36 Series

former type	Part No.	Replacement	Part No.
3031 RC 12S7	055 939	M36-078	801 420
3031 RC 12S9	055 940	M36-118	801 421

Basic Terms and Technical Information

Capacity Regulators

Regulator series ACP and CPHE are hot gas bypass regulators and serve the purpose of compensating excess compressor capacity. Thus they prevent the generation of evaporator pressures below predetermined levels.

In case of hot gas injection into the suction line, a liquid injection valve in conjunction with a solenoid valve is required to desuperheat the excessively hot suction gas. The capacity should not be reduced below 60% of maximum in this application to avoid oil return problems.

With hot gas injection at the evaporator inlet, no liquid injection valve is necessary. The injection must be such that the incremental gas volume is taken into account. No problems with oil return should be expected even when regulating 100% of capacity.

Evaporator Pressure Regulators

Series PRE regulators serve the purpose of maintaining evaporator pressure above certain predetermined levels. The most important application is the use of several evaporators with different evaporating temperatures in conjunction with a common suction line.

The freezing of water in water chillers and air conditioning systems can be safely prevented if evaporating temperatures are kept above 0°C, even when loads are greatly reduced.

Crankcase Pressure Regulators

Series PRC regulators serve the purpose of preventing excessively high suction pressures to protect compressor motors from overloading.

Excessively high suction pressures can occur at start-up of a refrigeration circuit in case of high loads and after defrost. Crankcase regulators are adjusted to the maximum allowed suction pressure rating of the compressors as given by the compressor manufacturers.

Selection Guide for Pressure Regulators

Selection Criteria	Series			
	ACP	CPHE	PRE	PRC
Capacity Regulator	+	+		
Evaporator Pressure Regulator			+	
Crankcase Pressure Regulator				+

Hot Gas Bypass Regulators Series ACP

Features

- High-quality materials and processes for high reliability and long lifetime
- Internal equalization
- Compact size

Technical Data

Adjustment Range	0 ... 5 bar
Factory Setting	2.7 bar
Max. allowable Pressure PS	31 bar
Medium Temperature Range TS	-40°C ... 120°C
Ambient Temperature Range	-40 ... 50°C
Transport Temperature Range	-40 ... 70°C



ACP

Capacity Data

Type	Part No.	Connection. Angle Solder/ODF inch	Nominal Bypass Capacity* Q _n			
			R134a	R22	R407C	R404A / R507
ACP 1	047 680	$\frac{1}{4} \times \frac{3}{8}$ "	0.21	0.35	0.41	0.30
ACP 3	047 283	$\frac{1}{4} \times \frac{3}{8}$ "	0.50	0.77	0.89	0.68
ACP 5	053 374	$\frac{3}{8} \times \frac{3}{8}$ "	1.18	1.83	2.12	1.59

* Nominal capacities at +38°C condensing temperature, +4°C evaporating temperature (saturated temperatures / dew point) and 1 K liquid subcooling at the inlet of the expansion valve.

Hot Gas Bypass Regulators Series CPHE

Features

- High-quality materials and processes for high reliability and long lifetime
- Superior partial load performance due to double seat orifice design (CPHE3 to CPHE6)
- Modular design for economical logistics and easy assembly and servicing
- External equalization

Specific connection sizes and flanges available on request.
For selection see last page of “Thermo-Expansion Valves” chapter.

Technical Data

Adjustment Range	-0.4 ... 5 bar
Factory Setting	1.4 bar
Max. allowable Pressure PS	35 bar
Medium Temperature Range TS	-40°C ... 120°C
Ambient Temperature Range	-40 ... 50°C
Transport Temperature Range	-40 ... 70°C



Capacity Data CPHE

Type	Nominal Bypass Capacity Qn				Orifice	Standard Flange		Power Assembly
	kW					Solder/ODF		
	R134a	R22	R407C	R404A / R507		mm	inch	
CPHE - 1X	3.5	5	5.8	4.5	X 22440-B5B	C 501 - 7 mm 12 x 16	C 501 - 7 ½ x ⅝	X7818 - 1
CPHE - 2X	6.4	9	10.4	8.1	X 22440-B8B	A 576 mm 16 x 22 (22 x 280 ODM)	A 576 ⅝ x ⅞ (⅞ x 1-⅛ ODM)	
CPHE - 3X	12	17	20	15	X 11873-B5B	10331 22 x 22	10331 ⅞ x ⅞ (1-⅛ x 1-⅛ ODM)	
CPHE - 3.5X	13	19	22	17	X 9117-B7B	9153 mm 22 x 22	9153 ⅞ x ⅞	
CPHE - 4X	16	23	27	21	X 9117-B9B			
CPHE - 5X	21	29	34	26	X 9166-B10B			
CPHE - 6X	35	50	58	45	X 9144-B13B	9149 22 x 22	9149 ⅞ x ⅞	

Nominal capacities at +38°C condensing temperature, +4°C evaporating temperature (saturated temperatures / dew point) and 1 K liquid subcooling at the inlet of the expansion valve.

Specific connection sizes and flanges available on request. For selection, see last page of “Thermo-Expansion Valves” chapter.

Correction Tables for Series ACP and CPHE

For other evaporating temperatures the bypass capacity Q_{Byp} shall be multiplied with the correction factor K_{Byp} .

$$Q_{Byp} \times K_{Byp} = Q_n$$

- Q_{Byp} : Required bypass capacity
- K_{Byp} : Correction factor for evaporating temperature
- Q_n : Nominal valve capacity

Refrigerant	Condensing Temperature °C	Correction Factor K_{Byp} Evaporating Temperature °C					
		+10	0	-10	-20	-30	-40
R134a	50	0.78	0.77	0.78	0.80		
	40	0.99	0.94	0.93	0.94		
	30	1.35	1.21	1.15	1.14		
R22	50	0.80	0.77	0.77	0.77	0.79	0.82
	40	1.00	0.93	0.91	0.91	0.92	0.95
	30	1.34	1.19	1.12	1.10	1.09	1.12
R407C	50	0.83	0.82	0.83	0.86		
	40	0.99	0.95	0.95	0.97		
	30	1.26	1.17	1.13	1.13		
R404A / R507	50	0.86	0.85	0.87	0.91	0.97	1.06
	40	0.99	0.95	0.94	0.96	1.00	1.05
	30	1.26	1.13	1.09	1.08	1.10	1.14

Evaporator and Crankcase Pressure Regulator Series PRE and PRC

Features

- Compact design permits minimal space requirements
- Schrader valve on inlet for ease of setting
- Direct operated regulator
- Balanced port design provides accurate pressure control
- Copper tubes for easy soldering



Technical Data

Refrigerants	HFC, HCFC
Oil compatibility	Mineral, Alkyl Benzene and Polyol-Ester (POE) lubricants
Max. allowable pressure PS Max. test pressure PT	25 bar 30 bar
Material, housing	CW509L (EN12420)
Temperature range	Storage -30°C to 80°C Medium TS -30°C to 80°C Ambient -30°C to 80°C

Pressure change per turn: Valve size 1 Valve size 2	0.6 bar 0.4 bar
Pressure range Factory setting	0.5 to 6.9 bar 2 bar
Weight: PRC/PRE-1.. PRC/PRE-2..	0.6 kg 1.3 kg

Evaporator Pressure Regulator Series PRE

Selection

Type	Part No.	Tube Connection ODF	Nominal Capacity* Q _n (kW)			
			R134a	R404A / R507	R407C	R22
PRE - 11A	800 380	16 mm - 5/8"	3.0	4.5	4.5	4.8
PRE - 11B	800 381	22 mm - 7/8"				
PRE - 21C	800 382	28 mm	7.4	11.1	11.1	11.9
PRE - 21D	800 383	1 - 1/8"				

*Nominal capacities are based on evaporating Temperature +4°C, condensing temperature +38°C and a pressure drop of 1K.

Correction Table

Selection for operating conditions other than +38°C/+4°C and 1 K liquid subcooling at the inlet of the valve: $Q_n = Q_0 \times K_t$

Q_n: Nominal valve capacity

Q₀: Required cooling capacity

Refrigerant	Condensing Temperature °C	Correction Factor K _t Evaporating Temperature °C				
		+10	0	-10	-20	-30
R404A / R507	60	1.35	1.91	2.77	4.18	6.53
	50	1.05	1.46	2.07	3.05	4.62
	40	0.88	1.22	1.71	2.48	3.69
	30	0.77	1.06	1.48	2.12	3.13
R407C	55	1.02	1.42	2.04		
	50	0.94	1.31	1.87		
	40	0.84	1.17	1.66		
	30	0.77	1.06	1.50		
R134a	60	1.04	1.51	2.17		
	50	0.92	1.34	1.91		
	40	0.83	1.20	1.71		
	30	0.76	1.10	1.55		
R22	60	1.02	1.37	1.87	2.67	3.91
	50	0.93	1.25	1.70	2.42	3.53
	40	0.86	1.15	1.57	2.22	3.23
	30	0.80	1.07	1.45	2.05	2.98

Crankcase Pressure Regulator Series PRC

Selection

Type	Part No.	Tube Connection ODF	Nominal Capacity* Q _n (kW)			
			R134a	R404A / R507	R407C	R22
PRC - 11A	800 384	16 mm - $\frac{5}{8}$ "	3.0	4.5	4.5	4.8
PRC - 11B	800 385	22 mm - $\frac{7}{8}$ "				
PRC - 21C	800 386	28 mm	7.4	11.1	11.1	11.9
PRC - 21D	800 387	1 - $\frac{1}{8}$ "				
PRC - 21E	800 388	35 mm - 1 - $\frac{3}{8}$ "				

*Nominal capacities are based on evaporating temperature +4°C and condensing temperature +38°C and a pressure drop of 1 K.

Capacity Table

Selection for operating conditions other than +38°C / +4°C and 1 K liquid subcooling at the inlet of the valve: (capacities are based on a pressure drop of 0.07 bar).

Refrigerant	Evaporating Temperature °C	Capacity (kW) Valve setting °C													
		Valve Size 1: PRC-11x							Valve Size 2: PRC-21x						
		-20	-15	-10	-5	0	+5	+10	-20	-15	-10	-5	0	+5	+10
R22	-29	2.3	3.4	4.4	4.8	4.9			5.8	8.8	10.0	10.0	10.0		
	-21		2.4	4.1	5.4	5.8				6.5	12.1	12.1	12.1		
	-14			2.7	4.9	6.2					8.1	13.8	13.8		
	-8				3.5	5.3						9.0	15.4		
	-3					3.1							9.9		
R407 C	-6				3.1	4.8						7.9	13.9		
	-1					2.9							9.2		
R134 a	-6					2.1	3.9	5.3					5.2	10.3	12.9
	1						2.4	4.7						6.1	12.2
	7							3.3							8.1
R404A / R507	-27	1.6	2.9	3.7	3.9				4.8	8.2	8.2	8.2			
	-20		1.9	3.5	4.5					5.7	9.8	9.8			
	-14			2.2	4.5						6.8	11.6			
	-10				3.1							8.1			

Pressure Controls and Thermostats

Pressure Controls

Basic Terms and Technical Information

Characteristics

Pressure controls serve various functions, which may be divided into control and protection functions. Examples for control functions are compressor cycling, pump-down or defrost control. Protection functions include pressure limiting and cut-out against excessive pressures, against loss of charge or for freeze protection. These functions are performed by operating a set of electrical contacts when exceeding a preset lower or upper pressure limit. Depending on whether they are type tested (TÜV approved) or not, they may be referred to by the following terms:

without TÜV approval:	Pressure Control
with TÜV approval:	Pressure Limiter, Pressure Cut-Out or Safety Pressure Cut-Out

Pressure controls with TÜV approval are tested according to EN 12263 as required by DIN 8901 and EN 378.

1. Pressure controls (without TÜV approval)

Pressure controls without type approval may either be of the automatic or manual reset type. Manual reset versions are available for decreasing (manual reset min.) or increasing pressure (manual reset max.).

2. Pressure limiters PSL/PSH

Pressure limiters are of the automatic reset type. Limiters for high pressure applications have a double bellows design to act as fail-safe controls.

3. Pressure cut-outs PZH/PZL

Pressure cut-outs are of the manual reset type where reset is possible from the outside of the control without the need for a tool (external reset). Cut-outs for high pressure applications have a double bellows design to act as fail-safe controls.

4. Safety pressure cut-outs PZHH/PZLL

Pressure cut-outs are of the manual reset type where the reset requires the use of a tool. Typically, the removal of a cover is required in order to press the reset button (internal reset). Cut-outs for high pressure applications have a double bellows design to act as fail-safe controls.

Adjustment of switching points

A pressure gauge should always be used for comparison when adjusting the switching points on pressure controls. The setting scale on the device is intended to serve for orientation, showing the setting range of the upper switching point p_{max} in bar/psig and the value of the pressure differential Δp as difference between upper switching point p_{max} and the lower switching point p_{min} . The upper switching point p_{max} has to be adjusted on the scale, whereas the lower switching point p_{min} is given by adjustment of the desired switching differential Δp .

The formula is:

$$\text{Upper switching point} - \text{Differential} = \text{Lower switching point}$$

$$P_{max} - \Delta p = P_{min}$$

Function of contacts SPDT

On pressure rise above setting 1-2 opens and 1-4 closes. On pressure drop below setting 1-2 closes and 1-4 opens.

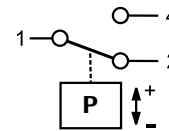

SPDT with manual reset max.

On pressure rise above setting 1-2 opens and 1-4 closes and latches. The device can be manually reset when the pressure has dropped below setting.

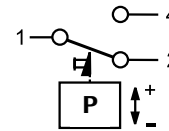

SPDT with manual reset min.

On pressure drop below setting 1-2 closes, 1-4 opens and latches. The device can be manually reset when the pressure has risen above setting.

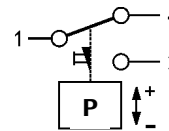

Unit of pressure

All pressures are given in gauge pressure

$$P_{absolute} = P_{gauge} + 1 \text{ bar}$$

$$1 \text{ bar} = 100 \text{ kPa}$$

$$1 \text{ bar} = 14.5 \text{ psi}$$

Pulsation damping

All high pressure controls with A-connection ($\frac{7}{16}$ -20UNF. $\frac{1}{4}$ " SAE male) are equipped with a snubber to protect the pressure element from pulsations.

Standards and Regulations

BGV D4 (VBG20)	Accident prevention regulations for refrigeration plant.
DIN 8901	Heat pumps with fluorocarbon refrigerants. Protection of soil, underground and surface water.
EN 60947-1/ EN 60947-5-1	Specifications for low-voltage switchgear.
EN 378	Refrigerating systems and heat pumps - Safety and environmental requirements.
EN 12263:	Refrigerating systems and heat pumps - Safety switching devices for limiting the pressure requirements and tests.

Selection Guide for Pressure Controls

Series	Selection Criteria					
	Design	Number of Contacts (SPDT)	Adjustable	Protection DIN 40050 IEC 529	Rated Operational Current at 230 V AC	
					Inductive Amp. AC 15	Motor Rating UL
PS1	Standard Model	1	yes	IP 44	10 A	24 A
PS2	Dual Pressure Switch	1+1	yes	IP 44	10 A	24 A
	Pressure Switch Standard-Types	1	Factory set to fixed values	IP 30 / IP 65	3 A	6 A
PS3	Pressure Switch OEM-Types	1	Fixed values acc. to customer spec. depending on volume	IP 30 / IP 65	3 A	6 A
PS4	Pressure Switch OEM-Types	1	no	IP67 (cable) IP20 (terminals)	6 A	6 A
FD 113	Differential Pressure Switch	1	yes pressure diff. + time delay	IP 30	3 A / 6 A	-

Pressure Controls Series PS1 / PS2

Features

- Adjustable pressure range
- Automatic and manual reset versions
- Flare and solder connections
- Chatter-resistant (bounce-free) contacts
- High operational current, locked rotor max. 144 Amps (LRA)
- Standard SPDT with same operational current rating for both contacts
- Dual pressostat with two separate SPDT for high and low pressure side
- Including sealable blocking plate and mounting screws





Options (minimum lot size 100 pieces)

- Convertible reset to reduce stock
- Further pressure connections
- Factory set to customer specification

Technical Data PS1 / PS2

Type of Contacts	1 SPDT for PS1 2 separate SPDT for PS2
Inductive Amp. (AC15) Inductive Amp. (DC13)	10 A / 230V AC 0.1 A / 230V DC
Motor Rating, Full Load Amp. Motor Rating, Locked Rotor Amp.	24 A / 120/240V AC 144 A / 120/240V AC

Standards

-  per Low Voltage Directive
-  per PED Directive 97/23 EG. TÜV appr. versions only
- Manufactured and tested to  standards on our own responsibility
-  US LISTED Underwriter Laboratories (File Nr. E85974)
- German Lloyd for use on ships, when equipped with marine-type cable gland



Protection acc. EN 60529 / IEC 529	IP 44
Ambient Temperature Range Max. Temperature at Pressure Connection	-50°C .. +70°C +70°C
Vibration Resistance (10 to 1000 Hz)	4 g
Cable Entry	Grommet PG 16
Locking Device	Blocking Plate
Mounting Screws	M4 / UNC 8-32

Single Pressure Controls PS1

Type	Part No.	Adjustment Range		Lowest Setpoint bar	Factory Setting bar	Leakage Test Pressure bar	Pressure Connection
		Upper Setpoint bar	Differential bar				
Low Pressure Controls							
PS1-A3A	4 370 700	-0.5 ... 7	0.5 ... 5	-0.9	3.5 / 4.5	24	7/16"-20 UNF
PS1-A3K	4 370 600						capillary/nut
PS1-A3L	4 714 945						cap./solder
PS1-A3U	4 712 201						solder 6 mm
PS1-A3X	4 713 430						solder 1/4"
PS1-R3A	4 350 100	-0.5 ... 7	external reset approx. 1 bar above setpoint	-0.9	3.5	24	7/16"-20 UNF
PS1-R3K	4 713 431						capillary nut
High Pressure Controls							
PS1-A5A	4 350 500	6 ... 31	2 ... 15	3	16 / 20	35	7/16"-20 UNF
PS1-A5K	4 370 400						capillary nut
PS1-A5L	4 715 136						cap./solder
PS1-A5U	4 713 325						solder 6 mm
PS1-A5X	4 713 434						solder 1/4"
PS1-R5A	4 350 700	6 ... 31	ext. manual reset approx. 3 bar below setpoint	-	20	35	7/16"-20 UNF
PS1-R5K	4 370 300						capillary nut

Single Pressure Controls Series PS1 TÜV / EN 12263

Type	Part No.	Adjustment Range		Lowest Setpoint bar	Factory Setting bar	Leakage Test Pressure bar	Pressure Connection
		Upper Setpoint bar	Differential bar				
Pressure Limiter for Low Pressure Protection PSL - Automatic Reset							
PS1-W3A	4 368 300	-0.5 ... 7	0.5 ... 5	-0.9	3.5 / 4.5	24	7/16"-20 UNF
PS1-W3U	4 713 437						solder 6 mm
Pressure Cut Out for Low Pressure Protection PZL - External Reset							
PS1-B3A	4 470 400	-0.5 ... 7	external reset approx. 1 bar above setpoint	-0.9	3.5	24	7/16"-20 UNF
PS1-B3U	4 715 141						solder 6 mm
Pressure Limiter for High Pressure Protection PSH - Automatic Reset							
PS1-W5A	4 353 200	6 ... 31	2 ... 15	3	16 / 20	35	7/16"-20 UNF
PS1-W5K	4 359 100						capillary/nut
PS1-W5U	4 713 439						solder 6 mm
Pressure Cut Out for High Pressure Protection PZH - External Manual Reset							
PS1-B5A	4 353 300	6 ... 31	external reset approx. 3 bar below setpoint	-	20	35	7/16"-20 UNF
PS1-B5U	4 712 332						solder 6 mm
Safety Pressure Cut Out for High Pressure Protection PZHH - Internal Manual Reset							
PS1-S5A	4 368 400	6 ... 31	internal reset approx. 3 bar below setpoint	-	21	35	7/16"-20 UNF
PS1-S5U	4 711 591						solder 6 mm

Dual Pressure Controls Series PS2



PS2

Type	Part No.	Adjustment Range				Factory Setting		Leakage Test Pressure		Pressure Connection
		Upper Setpoint		Differential				left bar	right bar	
		left bar	right bar	left bar	right bar	left bar	right bar			
Combined Low and High Pressure Controls										
PS2-A7A	4 353 400	-0.5 ... 7	6 ... 31	0.5 ^{a)} ... 5	ca. 4 fix	3.5 / 4.5	20	24	35	7/16"-20 UNF
PS2-A7K	4 350 900									capillary/nut
PS2-A7L	4 713 565									cap./solder
PS2-A7U	4 713 415									solder 6 mm
PS2-A7X	4 713 416									solder 1/4"
PS2-L7A	4 351 100	-0.5 ... 7	6 ... 31	0.5 ^{a)} ... 5	external reset approx. 4 bar under setpoint	3.5 / 4.5	20	24	35	7/16"-20 UNF
PS2-L7K	4 370 500									capillary/nut
PS2-L7U	4 713 417									solder 6 mm
PS2-R7A	4 351 300	-0.5 ... 7	6 ... 31	external reset approx. 1 bar above setpoint	external reset approx. 4 bar below setpoint	3.5	20	24	35	7/16"-20 UNF
PS2-R7K	4 713 421									capillary/nut
PS2-R7U	4 713 419									solder 6 mm

Dual Pressure Controls Series PS2 TÜV / EN 12263

Combined Pressure Limiter for Low Pressure / High Pressure Protection PSL / PSH - automatic / automatic										
PS2-W7A	4 360 100	-0.5 ... 7	6 ... 31	0.5 ^{a)} ... 5	ca. 4 fix	3.5 / 4.5	20	24	35	7/16"-20 UNF
PS2-W7L	4 450 300									cap./solder
PS2-W7U	4 712 436									solder 6 mm

Combined Pressure Limiter / Pressure Cut-Out for Low Pressure / High Pressure Protection PSL / PZH - automatic / external manual reset										
PS2-C7A	4 353 500	-0.5 ... 7	6 ... 31	0.5 ^{a)} ... 5	external reset approx. 4 bar below setpoint	3.5 / 4.5	20	24	35	7/16"-20 UNF
PS2-C7L	5 715 131									cap./solder

Combined Low and High Pressure Controls. High Side Convertible From Automatic to Manual Reset										
PS2-M7A	4 361 300	-0.5 .. 7	6 ... 31	0.5a ... 5	-	3,5 / 4,5	21	24	35	7/16"-20 UNF

Combined Pressure Limiter Safety Pressure Cut Out for low pressure / high pressure protection EN 12263 PSL / PZH (automatic / automatic convertible to external manual reset)										
PS2-N7A	4 715 756	-0.5 .. 7	6 ... 31	0.5a ... 5	-	3,5 / 4,5	21	24	35	7/16"-20 UNF

^{a)} lowest possible setpoint: -0.9 bar

Dual Pressure Controls PS2 TÜV / EN 12263

Type	Part No.	Adjustment Range				Factory Setting		Leakage Test Pressure		Pressure Connection
		Upper Setpoint		Differential				left bar	right bar	
		left bar	right bar	left bar	right bar	left bar	right bar			
Combined Pressure Limiter / Safety Pressure Cut-Out for Low Pressure / High Pressure Protection PSL / PZHH - automatic / internal manual reset										
PS2-T7A	4 368 500	-0.5 ... 7	6 ... 31	0.5 ^{a)} ... 5	internal reset approx. 4 bar below setpoint	3.5 / 4.5	20	24	35	7/16"-20 UNF
PS2-T7U	4 713 424									solder 6 mm

Combined Pressure Cut-Out for Low Pressure / High Pressure Protection PZL / PZH external manual reset / external manual reset										
PS2-B7A	4 360 200	-0.5 ... 7	6 ... 31	external reset approx. 1 bar above setpoint	external reset approx. 4 bar below setpoint	3.5	20	24	35	7/16"-20 UNF
PS2-B7K	4 446 600									capillary/nut
PS2-B7L	4 446 700									cap./solder
PS2-B7U	4 449 400									solder 6 mm

Combined Pressure Cut-Out / Safety Pressure Cut-Out for High Pressure Protection PZH / PZHH external manual reset / internal manual reset										
PS2-G8A	4 368 600	6 ... 31	6 ... 31	external reset approx. 4 bar below setpoint	internal reset approx. 4 bar below setpoint	20	21	35	35	7/16"-20 UNF
PS2-G8U	4 713 427									solder 6 mm
PS2-G8X	4 713 428									solder 1/4"

^{a)} lowest possible setpoint: -0.9 bar

Accessories

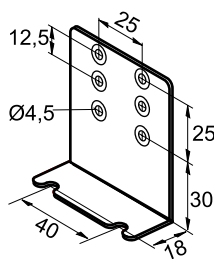

Mounting bracket angle
Part No.: 803 799

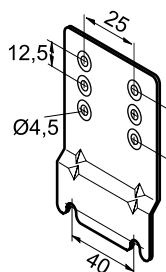

Mounting plate for units with hood
Part No.: 803 801

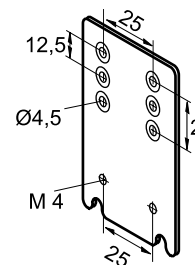

Extension bracket
Part No.: 803 800

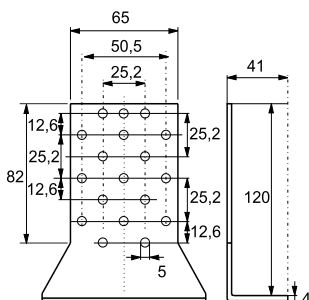

Universal mounting bracket
Part No.: 803 798

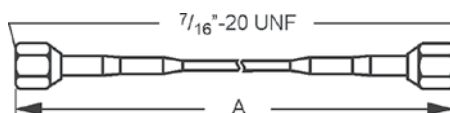

Capillary Tube with two flare nuts 7/16"-20 UNF. R 1/4"
1.5m
Part No.: 803 804

Copper Gasket Set for R 1/4"
(7/16"-20 UNF. female)
100 pcs package
Part No.: 803 780





Pressure Controls Series PS3 / Standard types

Compact Pressure Switch with fixed switch-point settings

Features

- Maximum allowable pressure up to 45 bar / test pressure up to 50 bar
- Standard factory settings from stock in small volumes
- High and low pressure switches
- High temperature version with snubber for direct compressor mounting (range 6)
- Direct mounting reduces the number of joints and thus avoiding potential leakage
- Precise setting and repeatability
- IP 65 protection if used with PS3-Nxx cables with plug (acc. EN 175301-803), no additional gasket required (molded into plug)
- Cables with plug to be ordered separately

Standards

-  per Low Voltage Directive
-  per PED Directive 97/23 EG, TÜV appr. versions only
- Manufactured and tested to  standards on our own responsibility
-  Underwriter Laboratories (File No. E85974) (Released for 43 bar)



PS3

Technical Data

Protection according to EN 60529 / IEC 529	IP 00 IP 30 with terminal cover IP 65 with PS3-Nxx cables with plug or Plug DIN 43650
Inductive Amp. (AC)	3A / 230V AC
Inductive Amp. (DC)	0.1A / 230V DC
Motor rating. full load Amp.	6A / 120/240V AC
Motor rating. locked rotor Amp.	36A / 120/240V AC

Temperature range TS * ambient. storage and transportation medium	-40 °C .. 70 °C -40 °C .. 70 °C (150°C range 6)
Pressure Range PS	- 0.6 .. 45 bar
Vibration resistance (10..1000 Hz)	4 g
Type of contacts	1 SPDT
Medium compatibility	HFC, HCFC

*Note: For high temperature applications, i. e., medium temperatures between 70 °C and 150 °C, the maximum ambient temperature must be derated as per drawing. E.g.: on medium temperature 120 °C the ambient temperature of 55 °C around the switch housing should not be exceeded.

Maximum Ambient Temperature (°C)

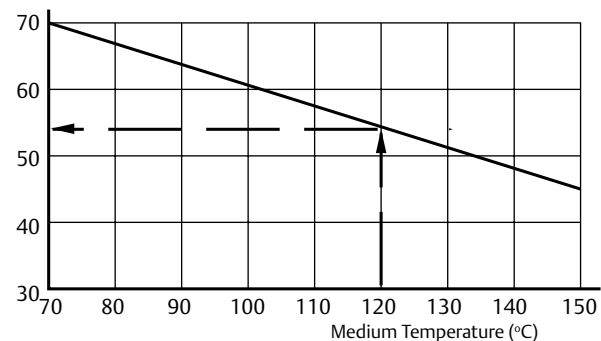

Pressure Controls Series PS3 / Standard types

Pressure Control Type	Part No.	Fixed setting		Reset	Max. Temperature		Leakage Test Pressure bar	Pressure Connection
		Cut-out bar	Cut-in bar		Ambient °C	Pressure Connection °C		
High Pressure Controls								
PS3-A6S	0 715 603	16.0	11.0	auto	+70	+150	50	7/16"-20UNF female thread with Schrader opener
PS3-A6S	0 715 604	19.0	15.0					
PS3-A6S	0 715 600	26.5	22.5					
Low Pressure Controls / Pressure Limiter for low pressure protection PSL TÜV / EN 12263								
PS3-W1S	0 714 760	-0.3	1.2	auto	+70	+70	30	7/16"-20UNF female thread with Schrader opener
PS3-W1S	0 714 761	0.3	1.8					
PS3-W1S	0 714 762	2.0	3.5					
Pressure Limiter for high pressure protection PSH TÜV / EN 12263								
PS3-W6S	0 715 831	14.0	10.0	auto	+70	+150	50	7/16"-20UNF female thread with Schrader opener and snubber
PS3-W6S	0 715 556	21.0	16.0					
PS3-W6S	0 715 555	25.0	20.0					
PS3-W6S	0 715 567	29.0	23.0					
PS3-W6S	0 715 550	33.5	27.5					
PS3-W6S	0 715 553	40.0	33.0					
Pressure Cut-Out for high pressure protection PZH with snubber for direct compressor mounting TÜV / EN 12263								
PS3-B6S	0 715 568	19.2	approx. 5 bar below cut-out	external manual reset	+70	+150	50	7/16"-20UNF female thread with Schrader opener and snubber
PS3-B6S	0 715 564	22.7						
PS3-B6S	0 715 563	27.3						
PS3-B6S	0 715 569	29.5						
PS3-B6S	0 715 560	36.0						

Selection Chart Cable Assemblies

Temperature Range -50 to 80°C / no UL		Length (mtr.)	Leads
Type	Part No.		
PS3-N15	804 580	1.5	3 x 0.75 mm ²
PS3-N30	804 581	3.0	
PS3-N60	804 582	6.0	



Plug according to EN 175301	Part No.
PG9	801 012
PG11	801 013

Pressure Controls Series PS3 / Special Types

For OEM use with settings according to customer's specification, minimum order quantity 100 pcs.

Features

- Maximum allowable pressure up to 45 bar / test pressure up to 50 bar
- For direct mounting on a pressure connection (free standing) or with a capillary tube
- Direct mounting reduces the number of joints and thus avoids potential leakage
- Direct mounting saves cost for flexible hose and additional fittings
- Precise setting and repeatability
- High temperature version with snubber, for direct compressor mounting (range 6)
- Micro switch for narrow pressure differentials
- Gold plated contacts for low voltage / current applications
- Worldwide approvals
- Easy mounting

Options

- Low pressure switch with automatic or manual reset
- High pressure switch with automatic or manual reset, standard or high temperature version
- Pressure limiter PSH - standard or high temperature version
- Pressure cut-out PZH - external reset, standard or high temperature version
- Safety pressure cut-out PZHH - internal reset, standard or high temperature version

Electrical connections (optional)

- Cables with plug in lengths of 1.5m, 3.0m and 6.0m available. No additional gasket required.
- Appliance socket DIN 43650

Type of contacts (optional)

- Standard (SPDT)
- Micro switch (SPDT)
- Gold plated contacts upon request

Technical Data

Protection according to EN 60529 / IEC 529	IP 00 IP 30 with terminal cover IP 65 with PS3-Nxx cables with plug or Plug DIN 43650
Inductive Amp. (AC15)	3 A / 230V AC 1.5 A with microswitch standard 0.1 A with gold plated contacts
Inductive Amp. (DC)	0.1 A / 230V DC
Motor rating, full load Amp.	6 A / 120/240V AC 2.5 A with microswitch
Motor rating, locked rotor Amp.	36 A / 120/240V AC 15 A with microswitch

For more information see datasheet PS3_e35003.



PS3

Standards

- per Low Voltage Directive
- per PED Directive 97/23 EG. TÜV appr. versions only
- Manufactured and tested to standards on our own responsibility
- Underwriter Laboratories (File No. E85974) (Released for 43 bar)
- **Pressure connections**
- S: $\frac{7}{16}$ "-20UNF, female with Schrader opener and snubber (snubber only with high temperature diaphragm)
- A: $\frac{7}{16}$ "-20UNF, $\frac{1}{4}$ " SAE male
- U: 6 mm solder. 80 mm length. ODF
- X: $\frac{1}{4}$ " solder. 80 mm length. ODF
- K: 1 m capillary tube with $\frac{1}{4}$ " SAE flare nut and Schrader opener
- L: 1 m capillary tube and $\frac{1}{4}$ " ODM solder connector

Installation

- Depending on pressure connection, free-standing or with console.

Temperature range TS	-40°C ... 70°C
Ambient. storage and transportation Medium	-40°C ... 70°C (150°C range 6)
Pressure Range PS	- 0.6 .. 45 bar
Vibration resistance (10..1000 Hz)	4 g (10 to 1000 Hz)
Type of contacts	1 SPDT
Medium compatibility	HFC, HCFC
Available approvals	TÜV, UL
Weight (approx.)	0.1 kg

PS4 Pressure Switch

with fixed settings for OEM applications; minimum lot size 100 pieces

Features

- High- and low pressure switches
- Precise settings and repeatability
- Protection per EN 60529:
- IP67 (cable version)
- IP20 (connector version QC)
- Direct mounting to the compressor possible
- Normally open/closed electrical contacts (under standard operating conditions)
- TUV approved versions
- Compatible with RoHS directive
- No options. Only available with the settings and connections styles as specified in selection tables below



PS4

Standards

- acc. Pressure Equipment Directive 97/23/EC
- Underwriter Laboratories file nr. E258370
- EN 60730-1, EN 60730-2-6, EN 60335-1

Low Pressure Switches With Automatic Reset; Open On Falling Pressure

Type	PCN	Setting (bar)		Connector (QC) Cable (m)	Test Pressure	EN 12263	Contact function	Application	Pressure connection
		Cut-out	Cut-in						
PS4-W1	808269	0.3	1.5	3.0	30 bar	PSL	open on falling pressure	low pressure	6mm
PS4-A3	808257	0.4	1.2	QC		7/16-20UNF*			
PS4-A1	808266	0.4	1.4	1.5		none			1/4"
PS4-A1	808245	0.5	1.5	1.5		PSL			7/16-20UNF*
PS4-W1	808208	0.6	1.8	1.5					6mm
PS4-W3	808235	0.6	1.8	QC		none			7/16-20UNF*
PS4-W1	808251	0.6	1.8	3.0					6mm
PS4-W1	808209	0.7	2.1	1.5		PSL			7/16-20UNF*
PS4-A1	808239	0.7	1.7	1.5					6mm
PS4-W1	808241	0.7	2.4	3.0		none			1/4"
PS4-W1	808258	0.7	2.1	1.5					7/16-20UNF*
PS4-A1	808259	0.7	2	1.5		PSL			6mm
PS4-A1	808247	1.5	2.5	2.5					7/16-20UNF*
PS4-A3	808252	1.5	2.5	QC		none			7/16-20UNF*
PS4-A1	808229	1.5	3.0	1.5					
PS4-W1	808210	1.7	3.4	1.5		PSL			6mm
PS4-W1	808249	1.7	3.4	1.5					
PS4-W3	808243	1.7	3.4	QC		none			7/16-20UNF*
PS4-W1	808271	1.8	3.2	1.5					
PS4-A1	808276	3.3	4.8	1.5		PSL			7/16-20UNF*
PS4-A1	808278	50/90 psig		1.5					
PS4-A3	808223	3.8	5.7	QC					

* 7/16-20UNF female with Schrader valve opener

High Pressure Switches With Automatic Reset; Open On Rising Pressure

Type	PCN	Setting (bar)		Connector (QC) Cable (m)	Test Pressure	EN 12263	Contact function	Application	Pressure connection			
		Cut-out	Cut-in									
PS4-W1	808200	18	13	1.5	41 bar	PSH	open on rising pressure	high pressure	7/16-20UNF*			
PS4-W1	808265	18	13	3.0					6mm			
PS4-W1	808201	26	20	1.5		PSH			7/16-20UNF*			
PS4-W1	808224	26	20	3.0					6mm			
PS4-W3	808236	26	20	QC		none			7/16-20UNF*			
PS4-W3	808250	26	20	QC					6mm			
PS4-A1	808260	26	20	1.5		55 bar			open on rising pressure	high pressure	1/4"	
PS4-W1	808203	28	21	1.5							PSH	7/16-20UNF*
PS4-A1	808233	28	21	1.5							none	7/16-20UNF*
PS4-A1	808244	28	21	1.5							PSH	1/4"
PS4-W3	808273	29	22.8	QC	7/16-20UNF Female with Schrader opener							
PS4-A1	808237	29.5	22.5	1.5	none		7/16-20UNF Female with Schrader opener					
PS4-A1	808246	30	24	2.5								
PS4-W1	808214	31	24	1.5	PSH							
PS4-A1	808238	31	24	1.5	none							
PS4-A3	808253	31	21	QC								
PS4-A1	808248	32	24	2.5	PSH							
PS4-A3	808222	41.7	33.4	QC								
PS4-W1	808205	42	33	1.5	69 bar	open on rising pressure		high pressure	7/16-20UNF Female with Schrader opener			
PS4-W3	808242	42	33	QC						PSH		
PS4-A1	808277	500/650 psig		1.5						none		
PS4-W1	808261	45	35	1.5			PSH					
PS4-A1	808275	48	34	1.5	none	6mm						
									7/16-20UNF*			

High Pressure Switches With Automatic Reset; Close On Rising Pressure

Type	PCN	Setting (bar)		Connector (QC) Cable (m)	Test Pressure	EN 12263	Contact function	Application	Pressure connection
		Cut-out	Cut-in						
PS4-A2	808212	13	18	1.5	41 bar	PSH	close on rising pressure	fan control	7/16-20UNF Female with Schrader opener
PS4-W2	808274	14.6	20	1.5					
PS4-A2	808263	16	21.3	1.5		none			
PS4-A2	808264	17	22.6	1.5					
PS4-A2	808213	18	24	1.5					
PS4-W2	808227	22	28	1.5	55 bar	PSH			

High Pressure Switches With Manual Reset; Open On Rising Pressure

Type	PCN	Setting (bar)		Connector (QC) Cable (m)	Test Pressure	EN 12263	Contact function	Application	Pressure connection
		Cut-out	Cut-in						
PS4-BL	808202	26	-	1.5	41 bar	PZH	open on rising pressure	high pressure EN 378	7/16-20UNF Female with Schrader opener
PS4-BL	808204	28	-	1.5	55 bar				
PS4-BL	808206	42	-	1.5	69 bar				

Technical Data

Type	PS4-A	PS4-W	PS4-BL
Electrical Data			
Inductive Load 230 VAC		0.1 – 6A	0.1 – 6A
Inductive Load (DC <28V)		2A	2A
Motor rating FLA 230 VAC		6A	6A
Motor rating LRA 230 VAC		36A	36A
Gold plated contacts (option)		25-100mA	25-100mA
Electrical Connection	Cable or Terminal (QC) Version		Cable Version
Life time	> 100.000 cycles		
Settings and Tolerances	see selection program		
Protection class IEC 529 / DIN 40050	IP67 (IP20 for Terminal Version)		
Vibration resistance (10 ... 250 Hz)	4 g		
Temperature range: Medium Ambient	-50°C ... 135°C -30°C ... 80°C (UL version 65°C)		
Compatibility *	HCFC, HFC, CO2, Mineral-, Synthetic-, POE-Lubricants		
Cable Version	18 AWG 0,8 mm ² , 600 V (max. 125°C)		
Cable Colour	LP: (0-8,5 bar: blue) HP: (>8,5 bar: black)		
Weight	approx. 100g		



*) PS4-Pressure Switch are not released for flammable refrigerants

Differential Pressure Controls Series FD 113

Features

- Immediate reset (no cooling down period)
- Precise timing
- Adjustable time delay from 20 to 150 sec (ZU types)
- Separate output signals for operation and alarm
- Suitable for supply voltage 24 to 240 V AC / DC
- Pressure connection: Flare $\frac{7}{16}$ "-20 UNF, $\frac{1}{4}$ " SAE male

Standards

-  per Low Voltage Directive
- Manufactured and tested to  standards on our own responsibility
-  US LISTED File No. E85974



FD 113

Type	Part No.	Time Delay		Cut out		Cut in Fixed Setting bar	Max. Differential Pressure bar	Max. Proof Pressure bar
		Adjustable	Factory Setting	Adjusting Range Δp	Factory Setting			
		Sec.	Sec.	bar	bar			
FD 113	0 710 173	-	-	0.3 ... 4.5	0.7	0.2 above cut-out	-0.8 ... 12	25
FD 113 ZU	3 465 300	20 ... 150	120					
FD 113 ZU (A22-057) Copeland™ brand products	0 711 195	-	115 fix	-	0.63 fix	appr. 0.9		

Technical Data

Inductive Amp. (AC)	3.0 A / 230 V AC
Inductive Amp. (DC)	0.1 A / 230 V DC
Protection acc. to EN 60 529	IP 30
Nominal Voltage FD 113 ZU	24 ... 240V AC / DC

Ambient Temperature Range	-20°C to +70°C
Max. Temperature at Pressure Connection	+70°C
Vibration resistance (10 to 1000 Hz)	4 g

Accessories

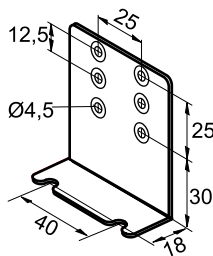

Mounting bracket angle
Part No.: 803 799

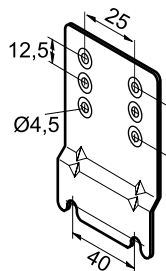

Mounting plate for units with hood
Part No.: 803 801

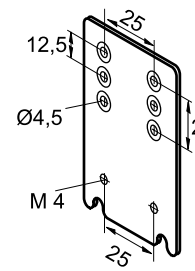

Extension bracket
Part No.: 803 800

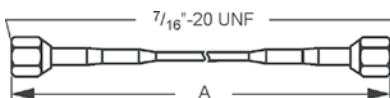

Capillary Tube with two flare nuts $\frac{7}{16}$ "-20 UNF. R $\frac{1}{4}$ "
1.5m
Part No.: 803 804

Copper Gasket Set for R $\frac{1}{4}$ " ($\frac{7}{16}$ "-20 UNF. female)
100 pcs package
Part No.: 803 780

Thermostats

Basic Terms and Technical Information

Characteristics

Alco thermostats are electric circuit control devices which open or close an electric contact depending on temperature changes at the bulb.

Description of bulb charges

The application range of thermostats is mainly determined by the charge. Accordingly, various bulb shapes and sizes are necessary.

- **Vapor charge, bulb type A, E, P**

The thermosystem is filled with a medium in vapor phase. A thermostat with vapor charge operates in accordance with temperature changes at the bulb as long as the bulb is the coldest part in the whole system (bellows, capillary tube, bulb). Alco thermostats are equipped with a bellows heater (82 k Ohm, 230 V) to avoid such conditions. On applications with low current the bellows heater has to be removed. Max. bulb temperature is 150°C (70°C for bulb type E). Response time is very fast.

- **Adsorption charge, bulb type F**

This charge only reacts on temperature changes at the bulb. Max. bulb temperature is 100°C. Response time is slow but perfectly suitable for common refrigeration systems.

Adjustment of switching points

A thermometer should always be used for comparison when adjusting the switching points on temperature controls. The setting scale on the device is intended to serve for orientation, showing the setting range of the upper switching point t_{max} in °C and °F and the value of the temperature differential Δt in K as difference between the upper switching point t_{max} and the lower switching point t_{min} . The upper switching point t_{max} has to be adjusted on the scale, whereas the lower switching point t_{min} is given by adjustment of the desired switching differential Δt . The formula is:

$$\text{Upper switching point} - \text{Differential} = \text{Lower switching point}$$

$$t_{max} - \Delta t = t_{min}$$

Important!

The differential Δt mentioned on the differential scale and in the technical data refers to the upper part of the setting range and the upper switching point.

In the lower part of the setting range an increase of the differential Δt can be expected. The lowest possible lower switching point t_{min} is mentioned in the selection tables and is helpful to select switching points with large differentials Δt in the lower temperature range.

Bulb Sizes

A	E	P	F
Vapor 2m, capillary with bulb	Vapor coil, 0m	Vapor 2m, capillary with function C and D 6m	Adsorption 2m, capillary with bulb

Function of Contacts

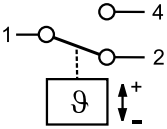
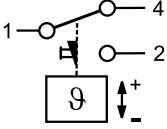
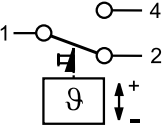
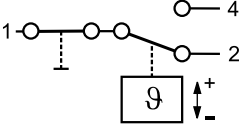
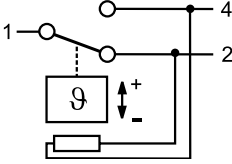
 <p>SPDT</p> <ul style="list-style-type: none"> - On temperature rise above setting 1-2 opens and 1-4 closes. - On temperature drop below setting 1-2 closes and 1-4 opens. 	 <p>SPDT with manual reset min.</p> <ul style="list-style-type: none"> - On temperature drop below setting 1-2 closes. 1-4 opens and latches. - The device can be manually reset when the temperature has risen at least 2K above setting. 	 <p>SPDT with manual reset max.</p> <ul style="list-style-type: none"> - On temperature rise above setting 1-2 opens and 1-4 closes and latches. - The device can be manually reset when the temperature has dropped 2K below setting.
 <p>SPDT with off switch AUTOmatic - STOP</p>		 <p>SPDT with bellows heater includes a 82 k Ohm, 230 V AC/DC resistor</p>

Standards and regulations

Important for the installation of thermostats:

EN 60730-2-9 Specification for temperature controls and temperature cut-outs.

EN 60947-1/ EN 60947-5-1 Specifications for low-voltage switchgear.

EN 378: Refrigerating systems and heat pumps. Safety and environmental requirements.

Thermostats Series TS1

Features

- Adjustable temperatures and differentials
- Shatter resistant contacts
- High operational current, locked rotor max. 144 Amps (LRA)
- Standard SPDT with same operational current rating for both contacts
- Captive terminal and cover screws
- Range and differential individually lockable

Technical Data

Type of Contacts	1 SPDT
Inductive Amp. (AC15)	10 A / 230 V AC
Inductive Amp. (DC13)	0.1 A / 230 V DC
Heating load (AC1)	24 A / 230 V AC
Motor Rating, Full Load Amp.	24 A / 120/240V AC
Motor Rating, Locked Rotor Amp.	144 A / 120/240V AC
Ambient Temperature Range	-50°C to +70°C
Vibration Resistance (10 to 1000 Hz)	4 g
Cable Entry	Grommet PG 16
Protection acc. to EN 60529 / IEC 529	IP 44 (IP 30 with Selector Switch)
Bellows Heater at Vapor Charge	82 K Ohm. 230 V AC / DC (12 and 24 V DC upon request)



Standards

- per Low Voltage Directive
- Manufactured and tested to standards on our own responsibility
- Underwriter Laboratories File Nr: E85974

Type	Part No.	Adjustment Range		Lowest Setpoint	Factory Setting	Max. Bulb Temp.	Temperature Sensor	
		Upper Setpoint	Differential Setpoint ΔT				Charge	Cap. tube length
		°C	K					
Thermostats Top Operated								
Thermostats without Off-Switch								
TS1-A2P	4 530 400	-30 ... +15	1.5 ... 16	-36	-1 / -6	+150	Vapor	2m capillary
TS1-A3P	4 356 700	-10 ... +35	1.5 ... 16	-23	+3 / -2			
TS1-A1A	4 351 500	-45 ... -10	1.5 ... 16	-55	-18 / -20	+150	Vapor	2m capillary and bulb
TS1-A2A	4 351 600	-30 ... +15	1.5 ... 16	-36	-1 / -6			
TS1-A3A	4 352 500	-10 ... +35	1.5 ... 16	-23	+3 / -2			
TS1-A4F Defrost- and Universal Thermostat	4 351 800	-30 ... +35	2.8 ... 20	-35	+5 / 0	+100	Adsorption	2m capillary and bulb
TS1-A5F	4 458 400	+20 ... +60	3 ... 10	+10	+35 / +30			
Thermostats with Off-Switch								
TS1-B1A	4 366 700	-45 ... -10	1.5 ... 16	-55	-18 / -20	+150	Vapor	2m capillary and bulb
TS1-B2A	4 366 800	-30 ... +15	1.5 ... 16	-36	-1 / -6			
TS1-B3A	4 366 900	-10 ... +35	1.5 ... 16	-23	+3 / -2			
TS1-B4F	4 367 000	-30 ... +35	2.8 ... 20	-35	+5 / 0	+100	Adsorption	
Frost Monitors Top Operated								
Frost Monitors without Off-Switch								
TS1-C0P	4 352 100	+4.5 ... +20	2.5 fix	+2	4.5 / +2	+150	Vapor	6m capillary
TS1-D0P Low temp. cut out	4 352 200	+4.5 ... +20	man. reset ca. 2.5 fix	+2	+2			

Type	Part No.	Adjustment Range		Lowest Setpoint	Factory Setting	Max. Bulb Temp.	Temperature Sensor	
		Upper Setpoint	Differential Setpoint ΔT				Charge	Cap. tube length
		°C	K					
Room Thermostats Top Operated								
Room Thermostats without Off-Switch, including insulation console								
TS1-A3E	4 355 300	-10 ... +35	1.5 ... 16	-23	+20 / +18	+70	Vapor	0m coil
Room Thermostats with Off-Switch, including insulation console								
TS1-B3E	4 344 500	-10 ... +35	1.5 ... 16	-23	+20 / +18	+70	Vapor	0m coil
Thermostats Front Operated								
Thermostats without Off-Switch								
TS1-E1A	4 361 000	-45 ... -10	2 ... 16	-55	-18 / -20	+150	Vapor	2m capillary and bulb
TS1-E2A	4 356 200	-30 ... +10	1.5 ... 15	-36	+4 / +2			
TS1-E3A	4 365 200	-10 ... +25	1.5 ... 15	-23	+3 / -2			
TS1-E4F Defrost- and universal thermostat	4 367 500	-25 ... +30	2.8 ... 20	-30	+5 / 0	+100	Adsorption	
TS1-E5F	4 338 100	+20 ... +60	3 ... 10	+10	+35 / +30			
Thermostats with Off-Switch								
TS1-F1A	4 367 100	-45 ... -10	2 ... 16	-55	-18 / -20	+150	Vapor	2m capillary and bulb
TS1-F2A	4 367 200	-30 ... +10	1.5 ... 15	-36	-1 / -6			
TS1-F3A	4 367 400	-10 ... +25	1.5 ... 15	-23	+3 / -2			
Room Thermostats Front Operated								
Room Thermostats without Off-Switch, including insulation console								
TS1-E1E	4 365 300	-45 ... -10	2 ... 16	-55	-18 / -20	+70	Vapor	0m coil
TS1-E2E	4 356 800	-30 ... +10	1.5 ... 15	-36	+4 / +2			
Room Thermostats with Off-Switch, including insulation console								
TS1-F1E	4 368 000	-45 ... -10	2 ... 16	-55	-18 / -20	+70	Vapor	0m coil
TS1-F2E	4 368 100	-30 ... +10	1.5 ... 15	-36	+4 / +2			
TS1-F3E	4 368 200	-10 ... +25	1.5 ... 15	-23	+20 / +18			
Thermostats for Flush Mounting								
Thermostats for Flush Mounting without Off-Switch								
TS1-G2A	4 355 400	-30 ... +15	1.5 ... 15	-36	+4 / +2	+150	Vapor	2m capillary and bulb
TS1-G4F Defrost- and universal thermostat	4 355 600	-30 ... +35	2.8 ... 20	-35	+5 / 0	+100	Adsorption	
TS1-G7F Milk and beer cooler thermostat	4 356 000	0 ... +10	2.5 fix	-2.5	+5.5 / +3			
Thermostats for Flush Mounting with Off-Switch								
TS1-H2A	4 355 500	-30 ... +15	1.5 ... 15	-36	-1 / -6	+150	Vapor	2m capillary and bulb
TS1-H3A	4 367 900	-10 ... +35	1.5 ... 15	-23	+3 / +2			

Accessories & Spare Parts

<p>Insulation Console for room thermostats standard Part No.: 0146 391</p>	<p>Capillary Tube Holder for frost monitors standard Part No.: 803 778</p>	
<p>Mounting Bracket Angle Part No.: 803 799</p>	<p>Mounting Plate for units with hood Part No.: 803 801</p>	<p>Extension Bracket Part No.: 803 800</p>
<p>Capillary Tube Gland. Brass for bulb style A / C Part No.: 803 807</p>	<p>Universal Mounting Bracket Part No.: 803 798</p>	

System Protectors and Moisture Indicators

Filter Driers

Basic Terminology and Technical Information

Function

The purpose of filter driers is to keep the refrigeration circuit clean of water, acid and solid contaminants. In case of contamination, corrosion and ice building can occur, as well as malfunction of the compressor.

Property of desiccants

Molecular sieves

This kind of desiccant has a very good drying effect independent of the oil content of the refrigerant. Molecular sieve is a fast acting desiccant and will remove moisture even when the water content of the refrigerant is low and when the temperature of the liquid refrigerant is high.

Activated alumina

Activated alumina incorporate an excellent acid capacity. By selecting a specific mixture of both desiccants, an optimum effect can be achieved to cover the requirements of all kinds of applications. Liquid filter driers are specially designed for a high water capacity, whereas suction line filter driers feature a high acid and filtration capacity.

Flow capacity

Flow capacity refers to ARI-Standard 710-86 and DIN 8949 and is based on a pressure drop of 0.07 bar, +30°C liquid temperature and -15°C evaporating temperature for common refrigerants.

The flow capacities are given at two levels of pressure drop: 0.07 and 0.14 bar.

For Filter drier selection under other operating conditions, use the correction factors given in tables at the end of liquid line filter driers BFK, ADK, FDB, ADKS, FDH, FDS

Water capacity

The water capacity for R22 refers to ARI 710-86 and DIN8948 is based on a liquid temperature of 24/52°C and an equilibrium point dryness (EPD) of 60 PPM water in refrigerant. The EPD for other refrigerants according to DIN 8949 is as follows:

Refrigerant	EPD (PPM)
R134a	50
R407C	50
R404A	50
R507	50
R410A	50

Selection Guide for Filter and Filter Driers

Selection criteria	Series										
	BFK	ADK	FDB	ADKS/FDH with core		FDS-24 with core		ASF	ASD	BTAS with core	
				H/S/W48	F48	S24	F24			AF	AF-D
Hermetic design	+	+	+					+	+		
For exchangeable cores				+	+	+	+			+	+
Quick cap flange						+	+				
Filter					+		+	+		+	
Filter drier	+	+	+	+		+			+		+
For liquid service	+	+	+	+		+					
For suction service					+	+	+	+	+	+	+
For Heat Pumps (Bi-Flow)	+										
Shell material	Steel	Steel	Steel	Steel		Steel		Steel	Steel	Brass	
Max. allowable pressure PS	45 bar	45 bar	45 bar	34.5*/46.0* bar		34.5* bar		27.5 bar		24 bar	

*dependent on medium temperature

Bi-flow Filter Driers Series BFK

Hermetic Design for Liquid Refrigerants

Features

- Solid block style
- Integrated check valves ensure Bi-flow capability, eliminate the need for external check valves and reduce the external piping
- ODF Copper fittings for easy soldering
- Pattern flow for non-turbulent performance
- High water, acid adsorption capacity
- Filtration down to 40 microns
- Temperature range TS: -45°C to +65°C
- Max. allowable pressure PS: 45 bar
- No CE marking according art. 3.3 PED 97/23 EC
- HP marking according to German Pressorized Vessel Directive
-  US LISTED Underwriter Laboratories



BFK

Type	Part No.	Connection size & type	Nominal Flow Capacity (KW)									
			at 0.07 bar pressure drop					at 0.14 bar pressure drop				
			R134a	R22	R407C	R404A R507	R410A	R134a	R22	R407C	R404A R507	R410A
BFK-052	007 343	1/4 "(6mm)SAE	5.2	5.7	5.4	3.7	5.6	8.0	8.8	8.4	5.7	8.7
BFK-052S	007 344	1/4"ODF	6.8	7.3	7.0	4.8	7.2	10.1	11.1	10.6	7.2	10.9
BFK-083	007 345	3/8 "(10mm)SAE	10.6	11.5	11.0	7.5	11.4	16.9	18.4	17.6	12.0	18.2
BFK-083S	007 346	3/8"ODF	12.0	13.1	12.5	8.5	12.9	20.6	22.5	21.5	14.7	22.2
BFK-084	007 347	1/2 "(12mm)SAE	15.2	16.6	15.8	10.8	16.4	25.8	28.1	26.8	18.3	27.8
BFK-084S	007 348	1/2"ODF	15.6	17.0	16.2	11.1	16.8	28.7	31.3	29.9	20.4	30.9
BFK-163	007 349	3/8 "(10mm)SAE	13.6	14.9	14.2	9.7	14.7	21.0	22.9	21.8	14.9	22.6
BFK-163S	007 350	3/8"ODF	15.5	16.9	16.1	11.0	16.7	23.8	26.0	24.8	17.0	25.7
BFK-164	007 351	1/2 "(12mm)SAE	20.3	22.1	21.1	14.4	21.9	27.5	30.0	28.6	19.6	29.6
BFK-164S	007 352	1/2"ODF	24.3	26.5	25.3	17.3	26.1	34.4	37.6	35.9	24.5	37.1
BFK-165	007 353	5/8 "(16mm)SAE	25.1	27.4	26.2	17.9	27.1	35.3	38.5	36.8	25.1	38.0
BFK-165S	007 354	5/8"ODF	25.6	28.0	26.7	18.3	27.6	37.0	40.4	38.5	26.3	39.9
BFK-305S	007 356	5/8 "(16mm) ODF	34.1	37.3	35.6	24.3	36.8	52.8	57.7	55.0	37.6	56.9
BFK-307S	007 357	7/8 "(22mm) ODF	40.6	44.3	42.3	28.9	43.7	65.7	71.7	68.4	46.8	70.8
BFK-309S	007 358	1 1/8"ODF	47.0	51.3	49.0	33.5	50.7	79.9	87.2	83.2	56.9	86.1

The rated flow capacities are in accordance with ARI standard 710-86 and DIN 8949 at +30°C liquid temperature and -15°C evaporating temperature.

Selection method for other conditions:

1. Determine the correction factor given in tables at the end of liquid line filter driers BFK, ADK, FDB, ADKS, FDH, FDS based on type of refrigerant, liquid and evaporating temperature.
2. Multiply the correction factor by cooling capacity or heating capacity, whichever is greater
3. Select the filter drier according to determined capacity corresponding to flow capacity at 0.07 bar pressure drop.

Water and Acid Adsorption Capacity

Type	Water adsorption capacity (gram)										Acid Adsorption Capacity (g)
	Liquid Temperature 24 °C					Liquid Temperature 52 °C					
	R134a	R22	R404A/R507	R407C	R410A	R134a	R22	R404A/R507	R407C	R410A	
BFK-05...	4.4	4.1	4.5	3.4	2.8	4.1	3.8	4.3	2.8	2.2	0.3
BFK-08...	9.6	9.0	9.9	7.5	6.2	8.9	8.2	9.4	6.0	4.7	0.6
BFK-16...	18.9	17.7	19.5	14.8	12.2	17.5	16.2	18.5	11.9	9.3	1.2
BFK-30...	34.5	32.3	35.6	27.1	22.4	31.9	29.6	33.7	21.7	17.0	2.0

Filter Driers Series ADK

Hermetic Design for Liquid Refrigerants

Features

- Robust block with optimum blend of molecular sieve and activated alumina
- ODF Copper fittings for easy soldering
- High water and acid capacity
- Filtration down to 40 microns
- Temperature range TS: -45°C to +65°C
- Max. allowable pressure PS: 45 bar
- No CE marking according art. 3.3 PED 97/23 EC
- HP marking according to German Pressurized Vessel Directive
-  Underwriter Laboratories



ADK

Type	Part No.	Nominal Flow Capacity (kW) nom. Conditions see next page													
		at 0.07 bar pressure drop							at 0.14 bar pressure drop						
		R22	R134a	R404A R507	R407C	R407F	R410A	R744	R22	R134a	R404A R507	R407C	R407F	R410A	R744
ADK-032	003 595	7.3	6.7	4.8	7.0	7.0	7.2	10.6	10.6	9.7	6.9	10.1	10.2	10.5	15.4
ADK-036MMS	003 597	8.0	7.3	5.2	7.6		7.9	11.6	12.0	11.0	7.8	11.4		11.8	17.4
ADK-032S	003 596	8.8	8.1	5.7	8.4	8.5	8.7	12.8	12.9	11.8	8.4	12.3	12.4	12.7	18.8
ADK-052	003 598	7.6	6.9	4.9	7.2	7.3	7.5	11.0	11.0	10.1	7.2	10.5	10.6	10.9	16.0
ADK-056MMS	003 600	10.0	9.2	6.5	9.5		9.9	14.5	15.0	13.7	9.8	14.3		14.8	21.8
ADK-052S	003 599	10.8	9.9	7.0	10.3	10.4	10.7	15.7	17.1	15.6	11.1	16.3	16.5	16.9	24.8
ADK-053	003 601	14.2	13.0	9.2	13.5	13.6	14.0	20.6	21.3	19.5	13.9	20.3	20.5	21.0	31.0
ADK-0510MMS	003 603	16.4	15.0	10.7	15.6		16.1	23.8	24.1	22.1	15.7	23.0		23.8	35.1
ADK-053S	003 602	16.4	15.0	10.7	15.6	15.8	16.1	23.8	24.1	22.1	15.7	23.0	24.8	23.8	35.1
ADK-082	003 604	7.8	7.1	5.1	7.4	7.5	7.7	11.3	11.3	10.4	7.4	10.8	10.9	11.2	16.4
ADK-086MMS	003 606	10.7	9.8	7.0	10.2		10.5	15.5	16.0	14.7	10.4	15.3		15.8	23.3
ADK-082S	003 605	11.9	10.9	7.8	11.4	11.5	11.8	17.4	17.3	15.9	11.3	16.5	16.7	17.1	25.2
ADK-083	003 607	16.4	15.0	10.7	15.6	16.0	16.2	23.8	23.9	21.9	15.6	22.8	23.1	23.6	34.8
ADK-0810MMS	003 609	16.4	15.0	10.7	15.6		16.2	23.8	24.1	22.1	15.7	23.0		23.8	35.0
ADK-083S	003 608	16.4	15.0	10.7	15.7	15.8	16.2	23.9	24.1	22.1	15.7	23.0	23.3	23.8	35.1
ADK-084	003 610	25.7	23.5	16.7	24.5	24.7	25.3	37.3	39.1	35.8	25.5	37.3	37.7	38.6	56.9
ADK-0812MMS	003 612	26.3	24.1	17.2	25.1		26.0	38.3	39.5	36.2	25.8	37.7		39.0	57.4
ADK-084S	003 611	26.8	24.5	17.5	25.6	25.8	26.4	39.0	40.4	37.0	26.3	38.5	38.9	39.8	58.7
ADK-162	003 613	8.0	7.3	5.2	7.6	7.7	7.8	11.6	11.5	10.5	7.5	10.9	11.0	11.3	16.7
ADK-163	003 614	16.8	15.4	10.9	16.0	16.2	16.5	24.4	24.1	22.1	15.7	23.0	23.3	23.8	35.1
ADK-1610MMS	003 616	18.7	17.1	12.2	17.8		18.5	27.2	26.8	24.5	17.5	25.6		26.5	39.0
ADK-163S	003 615	18.7	17.2	12.2	17.9	18.1	18.5	27.2	26.8	24.5	17.5	25.6	25.8	26.5	39.0
ADK-164	003 617	31.3	28.7	20.4	29.9	34.1	30.9	45.5	47.1	43.2	30.7	45.0	47.2	46.5	68.6
ADK-1612MMS	003 619	32.3	29.6	21.1	30.8		31.9	47.0	48.5	44.4	31.6	46.3		47.9	70.5
ADK-164S	003 618	36.0	33.0	23.5	34.3	35.1	35.5	52.3	49.9	45.7	32.6	47.6	48.1	49.3	72.6
ADK-165	003 620	44.8	41.1	29.2	42.8	43.2	44.3	65.2	66.5	60.9	43.4	63.5	64.1	65.7	96.7
ADK-165S	003 621	49.7	45.6	32.4	47.4	47.9	49.1	72.3	72.4	66.3	47.2	69.1	69.8	71.5	105.3
ADK-303	003 622	17.7	16.2	11.5	16.9	17.1	17.5	25.7	25.4	23.2	16.5	24.2	24.5	25.0	36.9
ADK-304	003 623	31.3	28.7	20.4	29.9	30.2	30.9	45.5	47.1	43.2	30.7	45.0	45.5	46.5	68.6
ADK-304S	003 624	36.0	33.0	23.5	34.4	34.7	35.6	52.4	51.6	47.2	33.6	49.2	49.7	50.9	75.0
ADK-305	003 626	52.6	48.2	34.3	50.2	50.7	52.0	76.6	72.1	66.0	47.0	68.7	69.5	71.1	104.8
ADK-305S	003 627	52.8	48.4	34.4	50.4	46.4	52.1	76.8	72.9	66.8	47.6	69.6	70.3	72.0	106.1
ADK-307S	003 628	66.3	60.7	43.2	63.2	63.9	65.4	96.4	104.6	95.8	68.2	99.8	100.8	103.2	152.1
ADK-414	003 629	36.8	33.7	24.0	35.1		36.3	53.5	55.2	50.6	36.0	52.7		54.5	80.3
ADK-415	003 632	58.6	53.7	38.2	55.9		57.8	85.2	87.9	80.5	57.3	83.9		86.8	127.8
ADK-415S	003 633	63.0	57.7	41.1	60.1		62.2	91.6	94.5	86.6	61.6	90.2		93.3	137.4
ADK-417S	003 634	77.9	71.4	50.8	74.3	80.0	76.9	113.3	116.9	107.1	76.2	111.5	121.7	115.4	170.0
ADK-757S	003 635	105.5	96.7	68.8	100.7	122.8	104.2	153.5	158.3	145.0	103.2	151.0	163.8	156.2	230.2
ADK-759S	003 636	117.2	107.4	76.4	111.8	133.9	115.7	170.4	175.8	161.0	114.6	167.7	173.2	173.5	255.6

Water and Acid Capacity

Size	Water adsorption capacity (gram)										Acid Adsorption Capacity (gram)
	Liquid Temperature 24 °C					Liquid Temperature 52 °C					
	R134a	R22	R404A/R507	R407C	R410A	R134a	R22	R404A/R507	R407C	R410A	
ADK-03	4.9	4.5	4.9	3.4	2.8	4.4	4.0	4.6	2.9	2.4	0.8
ADK-05	11.8	10.8	11.8	8.2	6.8	10.6	9.6	10.9	7.0	5.8	2.3
ADK-08	17.9	16.4	18.0	12.4	10.3	16.2	14.6	16.6	10.7	8.8	3.3
ADK-16	23.0	21.0	23.1	16.0	13.2	20.8	18.8	21.3	13.8	11.4	4.5
ADK-30	51.8	48.6	53.5	36.9	30.6	47.4	43.3	49.3	31.8	26.3	11.3
ADK-41	81.7	76.6	84.3	58.2	48.3	74.8	68.3	77.8	50.2	41.4	16.8
ADK-75	143.5	134.5	148.1	102.1	84.8	131.4	120.0	136.6	88.1	72.8	29.9

The water capacities are according to ARI-Standard 710 for R22 and are based on an equilibrium point dryness (EPD) of 60 PPM water in refrigerant. The EPD for all other mentioned refrigerants according to DIN 8949 is 50 PPM.

Connections

Type	Part No.	Connection			
		Solder/ODF		Flare/SAE	
		mm	inch	mm	inch
ADK-032	003 595			6	1/4
ADK-036MMS	003 597	6			
ADK-032S	003 596		1/4		
ADK-052	003 598			6	1/4
ADK-056MMS	003 600	6			
ADK-052S	003 599		1/4		
ADK-053	003 601			10	3/8
ADK-0510MMS	003 603	10			
ADK-053S	003 602		3/8		
ADK-082	003 604			6	1/4
ADK-086MMS	003 606	6			
ADK-082S	003 605		1/4		
ADK-083	003 607			10	3/8
ADK-0810MMS	003 609	10			
ADK-083S	003 608		3/8		
ADK-084	003 610			12	1/2
ADK-0812MMS	003 612	12			
ADK-084S	003 611		1/2		
ADK-162	003 613			6	1/4
ADK-163	003 614			10	3/8
ADK-1610MMS	003 616	10			
ADK-163S	003 615		3/8		
ADK-164	003 617			12	1/2
ADK-1612MMS	003 619	12			
ADK-164S	003 618		1/2		
ADK-165	003 620			16	5/8
ADK-165S	003 621		5/8		
ADK-303	003 622			10	3/8
ADK-304	003 623			12	1/2
ADK-304S	003 624		1/2		
ADK-305	003 626			16	5/8
ADK-305S	003 627		5/8		
ADK-307S	003 628	22	7/8		
ADK-414	003 629			12	1/2
ADK-415	003 632			16	5/8
ADK-415S	003 633		5/8		
ADK-417S	003 634	22	7/8		
ADK-757S	003 635	22	7/8		
ADK-759S	003 636		1-1/8		

Nominal Operating Conditions

Nominal capacity is based on the following conditions:

Refrigerant	Evaporating temperature	Liquid temperature
R744	-40°C	-10°C
R22, R134a, R404A, R407C, R407F, R410A, R507	-15°C	+30°C

Correction factors for other than the nominal conditions use the correction factors given in tables at the end of liquid line filter driers BFK, ADK, FDB, ADKS, FDH, FDS

Filter Driers Series FDB

Hermetic Design, Bead Style for Liquid Refrigerants

Features

- Compacted bead style (spring loaded)
- Optimum blend of molecular sieve and activated alumina combined with high filtration capacity
- Final filtration 20 micron
- Filtration first for more effective use of surface area of desiccant
- High water and acid capacity
- Cushioned flow for non-turbulent performance
- ODF Copper fittings for easy soldering
- Rugged steel shells
- Corrosion-resistant epoxy paint
- Temperature range TS: -40°C to +65°C
- Max. allowable pressure PS: 45 bar
- No CE marking according art. 3.3 PED 97/23 EC
- HP marking according to German Pressurized Vessel Directive



FDB

 Underwriter Laboratories

Type	Part No.	Nominal Flow Capacity (kW) nom. Conditions see next page									
		at 0.07 bar pressure drop					at 0.14 bar pressure drop				
		R134a	R22	R407C	R404A/R507	R410A	R134a	R22	R407C	R404A/R507	R410A
FDB-032	059 305	6.3	6.9	6.6	4.5	6.8	8.9	9.7	9.3	6.3	9.6
FDB-032S	059 306	9.7	10.6	10.1	6.9	10.5	13.7	15.0	14.3	9.8	14.8
FDB-052	059 307	6.5	7.1	6.8	4.6	7.0	9.3	10.2	9.7	6.7	10.1
FDB-052S	059 309	9.7	10.6	10.1	6.9	10.5	13.7	15.0	14.3	9.8	14.8
FDB-053	059 308	15.5	16.9	16.1	11.0	16.7	22.2	24.2	23.1	15.8	23.9
FDB-053S	059 310	19.3	21.1	20.1	13.8	20.8	27.6	30.1	28.7	19.6	29.7
FDB-082	059 311	6.8	7.4	7.1	4.8	7.3	9.8	10.7	10.2	7.0	10.6
FDB-082S	059 314	9.9	10.8	10.3	7.0	10.7	14.2	15.5	14.8	10.1	15.3
FDB-083	059 312	15.8	17.2	16.4	11.2	17.0	22.6	24.7	23.6	16.1	24.4
FDB-083S	059 315	19.8	21.6	20.6	14.1	21.3	28.4	31.0	29.6	20.2	30.6
FDB-084	059 313	26.4	28.8	27.5	18.8	28.4	37.7	41.2	39.3	26.9	40.7
FDB-084S	059 316	28.3	30.9	29.5	20.1	30.5	40.4	44.1	42.1	28.8	43.5
FDB-162	059 317	6.8	7.4	7.1	4.8	7.3	9.8	10.7	10.2	7.0	10.6
FDB-163	059 318	16.2	17.7	16.9	11.5	17.5	23.1	25.2	24.0	16.4	24.9
FDB-163S	059 321	23.0	25.1	23.9	16.4	24.8	32.9	35.9	34.2	23.4	35.4
FDB-164	059 319	27.9	30.5	29.1	19.9	30.1	39.9	43.6	41.6	28.4	43.0
FDB-164S	059 322	36.0	39.3	37.5	25.6	38.8	51.5	56.2	53.6	36.6	55.5
FDB-165	059 320	36.6	40.0	38.2	26.1	39.5	52.4	57.2	54.6	37.3	56.5
FDB-165S	059 323	48.8	53.3	50.8	34.8	52.6	69.7	76.1	72.6	49.6	75.1
FDB-303	059 324	18.0	19.7	18.8	12.8	19.4	25.7	28.1	26.8	18.3	27.7
FDB-304	059 325	31.8	34.7	33.1	22.6	34.2	45.3	49.5	47.2	32.3	48.9
FDB-304S	003 667	38.0	41.5	39.6	27.1	41.0	54.2	59.2	56.5	38.6	58.4
FDB-305	059 326	40.3	44.0	42.0	28.7	43.4	57.7	63.0	60.1	41.1	62.2
FDB-305S	059 327	53.8	58.7	56.0	38.3	57.9	76.9	83.9	80.0	54.7	82.8
FDB-307S	059 328	60.5	66.1	63.1	43.1	65.2	86.6	94.5	90.2	61.6	93.3
FDB-415	059 329	49.7	54.3	51.8	35.4	53.6	71.1	77.6	74.0	50.6	76.6
FDB-417S	059 330	77.2	84.3	80.4	55.0	83.2	110.3	120.4	114.9	78.5	118.8

Water Adsorption Capacity

Type	Unit Size	Water adsorption capacity (net) in grams							
		25 °C liquid refrigerant				52 °C liquid refrigerant			
		R134a	R22	R407C	R404A/R507	R134a	R22	R407C	R404A/R507
FDB-03...	3	1.9	2.0	1.7	1.9	1.8	1.7	1.6	1.9
FDB-05...	5	5.5	5.8	5.0	5.5	5.2	4.9	4.5	5.3
FDB-08...	8	8.8	9.3	8.0	8.8	8.4	7.9	7.2	8.5
FDB-16...	16	17.7	18.5	15.9	17.6	16.8	15.7	14.5	17.1
FDB-30...	30	31.7	33.0	28.5	31.6	30.1	28.2	26.0	30.5
FDB-41...	41	44.2	46.2	39.9	44.1	42.1	39.4	36.3	42.7

The water capacities are according to ARI-Standard 710 for R22 and are based on a equilibrium point dryness (EPD) of 60 PPM water in refrigerant. The EPD for all other mentioned refrigerants according to DIN 8949 is 50 PPM.

Connections

Type	Part No.	Connection	
		Solder/ODF or Flare/SAE	
		inch	mm
FDB-032	059 305	1/4"SAE	6mm SAE
FDB-032S	059 306	1/4"ODF	
FDB-052	059 307	1/4"SAE	6mm SAE
FDB-052S	059 309	1/4"ODF	
FDB-053	059 308	3/8"SAE	10mm SAE
FDB-053S	059 310	3/8"ODF	
FDB-082	059 311	1/4"SAE	6mm SAE
FDB-082S	059 314	1/4"ODF	
FDB-083	059 312	3/8"SAE	10mm SAE
FDB-083S	059 315	3/8"ODF	
FDB-084	059 313	1/2"SAE	12mm SAE
FDB-084S	059 316	1/2"ODF	
FDB-162	059 317	1/4"SAE	6mm SAE
FDB-163	059 318	3/8"SAE	10mm SAE
FDB-163S	059 321	3/8"ODF	
FDB-164	059 319	1/2"SAE	12mm SAE
FDB-164S	059 322	1/2"ODF	
FDB-165	059 320	5/8"SAE	16mm SAE
FDB-165S	059 323	5/8"ODF	
FDB-303	059 324	3/8"SAE	10mm SAE
FDB-304	059 325	1/2"SAE	12mm SAE
FDB-304S	003 667	1/2"ODF	
FDB-305	059 326	5/8"SAE	
FDB-305S	059 327	5/8"ODF	16mm SAE
FDB-307S	059 328	7/8"ODF	
FDB-415	059 329	5/8"SAE	16mm SAE
FDB-417S	059 330	7/8"ODF	

Nominal Operating Conditions

Nominal capacity is based on the following conditions:

Refrigerant	Evaporating temperature	Liquid temperature
R22, R134a, R404A, R407C, R410A, R507	-15°C	+30°C

Correction factors for other than the nominal conditions, see the correction factors given in tables at the end of liquid line filter driers BFK, ADK, FDB, ADKS, FDH, FDS in this chapter.

Filter Drier Shells Series ADKS-Plus

For Liquid- and Suction Applications with Replaceable Cores

Features

- Rustproof Aluminum flange cover with notch hole for ease of mounting
- ODF Copper fittings for easy soldering
- Rigid core holder from steel (no plastic)
- Service-friendly core holder and flange cover
- Optimum flow capacity at low pressure drop
- Temperature range TS: -45°C to +65°C
- Max. allowable pressure PS:
34,5 bar (-10°C to +65°C)
25,9 bar (-45°C to -10°C)
- CE marking according PED 97/23 EC
-  Underwriter Laboratories



ADKS-Plus

Type ADKS-Plus	Part No.	Connection Solder/ODF		Nominal Flow Capacity (kW)										Number of Blocks S48, H48 W48, F48
				Pressure Drop 0.07 bar					Pressure Drop 0.14 bar					
				mm	inch	R22	R134a	R404A R507	R407C	R410A	R22	R134a	R404A R507	
Conformity assessment cat. I, procedure module A														
485T	883 551	16	5/8"	78	72	51	75	77	100	92	65	95	99	1
487T	883 552	22	7/8"	145	133	95	138	143	182	167	119	174	180	
489T	883 553		1 1/8"	204	187	133	195	202	262	240	171	250	258	
4811T	883 554	35	1 3/8"	285	261	186	272	281	355	325	231	338	350	
4813T MM	883 836	42		310	284	202	196	306	390	357	254	372	385	
4817	882 603	54	2 1/8"	Primary for suction line applications										
967T	883 555	22	7/8"	159	146	104	152	157	199	182	129	189	196	2
969T	883 556		1 1/8"	250	229	163	239	247	300	275	196	286	296	
9611T	883 557	35	1 3/8"	305	279	199	291	301	402	369	262	384	397	
9613T	883 558		1 5/8"	350	321	228	334	345	470	431	306	448	464	
9613T MM	883 559	42		355	325	231	339	350	480	440	313	458	474	
9617	887 215	54		350	321	228	334	345	470	431	306	448	464	
1449T	883 560		1 1/8"	252	231	165	241	249	313	287	204	299	309	3
14411T	883 561	35	1 3/8"	351	322	229	335	347	438	401	285	417	432	
14413T	883 562		1 5/8"	354	325	231	338	350	482	441	314	460	476	
14413T MM	883 563	42		360	330	235	343	355	490	449	319	467	484	
14417T	883 564	54	2 1/8"	420	385	274	401	415	560	513	365	534	553	
Conformity assessment cat. II, procedure module D1														
19211T	883 565	35	1 3/8"	358	328	233	342	353	440	403	287	419	434	4
19213T	883 566		1 5/8"	395	362	258	377	390	506	464	330	483	500	
19213T MM	883 567	42		400	366	261	382	395	510	467	333	487	503	
19217T	883 568	54	2 1/8"	430	394	281	411	425	567	519	370	541	560	

Correction factors for other than the nominal conditions use the correction factors given in tables at the end of liquid line filter driers BFK, ADK, FDB, ADKS, FDH, FDS
Cores see next page.

Nominal Operating Conditions

Nominal capacity (Qn) is based on the following conditions:

Refrigerant	Evaporating temperature	Liquid temperature
R744	-40°C	-10°C
R22, R134a, R404A, R407C, R410A, R507	-15°C	+30°C

Correction factors for other than the nominal conditions see next pages.

Filter Drier Shells Series FDH

For Liquid- and Suction Applications with Replaceable Cores

Features

- Steel flange cover with notch hole for ease of mounting
- Plated steel ODF connections
- Rigid core holder from steel (no plastic)
- Service-friendly core holder and flange cover
- Optimum flow capacity at low pressure drop
- Temperature range TS: -45°C to +65°C
- Max. allowable pressure PS:
46 bar (-10°C to +65°C)
25,9 bar (-45°C to -10°C)
- CE marking according PED 97/23 EC



FDH

Type	Part No.	Connection Solder/ODF		Nominal Flow Capacity (kW)												Number of Blocks
				Pressure Drop 0.07 bar						Pressure Drop 0.14 bar						
		mm	inch	R22	R134a	R404A R507	R407C	R410A	R744	R22	R134a	R404 R507	R407C	R410A	R744	
Conformity assessment cat. I, procedure module A																
FDH-485	880 300	16	5/8"	78	72	51	75	77	114	100	92	65	95	99	146	1
FDH-487	880 301	22	7/8"	145	133	95	138	143	211	182	167	119	174	180	265	
FDH-489	880 302		1 1/8"	204	187	133	195	202	297	262	240	171	250	258	380	
FDH-969	880 306		1 1/8"	250	229	163	239	247	364	300	275	196	286	296	436	2
FDH-9611	880 307	35	1 3/8"	305	279	199	291	301	443	402	369	262	384	397	585	

Nominal conditions see previous page.

Correction factors for other than the nominal conditions see next pages.

Features

- Water capacities to suit specific system conditions
- Exceptional acid capacities for normal system protection, or to effectively clean-up following a compressor burnout (W48)



Core H48

Cores for ADKS-Plus and FDH have to be ordered separately

Size	Part No.	Water Adsorption Capacity (gram)								Acid Adsorption capacity (g)
		Liquid Temperature 24°C				Liquid Temperature 52°C				
		R134a	R22	R404A R507	R407C	R134a	R22	R404A R507	R407C	
S48	003 508	79,7	74,7	82,3	56,7	73,0	66,7	75,9	48,9	16,3
H48	006 969	35,0	31,7	37,0	24,4	29,0	24,5	28,9	18,1	44,6
W48	006 970	24,7	22,1	26,2	17,1	19,9	16,4	19,5	12,1	39,7
F48	006 973	Filter for suction line								
H100 / W100 are for use with phased-out ADKS-300/-400 only										
H100	006 971	59,9	53,3	63,8	41,2	47,4	38,3	46,0	28,5	105,1
W100	006 972	52,7	47,1	56,0	36,4	42,4	34,7	41,4	25,7	85,5

Filter-Drier Shells With Quick-Cap Series FDS-24

For Liquid- and Suction Applications with Replaceable Cores

Features

- Quick-cap flange (one bolt) design makes replacing of cores in a matter of seconds
- Ideal for retrofit, reducing installation / material cost
- Ideal for refrigerant recovery / reclaim units with regular change of filter-drier
- Compatible with CFC, HCFC and HFC refrigerants
- Free volume as a receiver in FDS-24... (580 cm³)
- ODF Copper fittings for easy soldering
- Corrosion-resistant powder painting of shell body
- Temperature range TS: -45°C to +65°C
Max. allowable pressure PS:
34,5 bar (-10°C to +65°C)
25,9 bar (-45°C to -10°C)
- No CE marking according art.3.3 PED 97/23 EC
- HP marking according to German Pressurized Vessel Directive



FDS-24

Selection Chart Suction Application

Type	Part No.	Connection		Nominal Flow Capacity (kW)							
		mm	inch	Block Core S24				Filter F24			
				R134a	R22	R407C	R507/R404A	R134a	R22	R407C	R507/R404A
FDS-245	003 573	16	5/8	22.3	30.6	28.5	26.0	24.7	33.9	31.5	28.8
FDS-247	003 574	22	7/8	32.2	44.1	44.1	37.5	37.8	51.8	48.2	44.0
FDS-249	003 575		1-1/8	46.0	63.0	58.6	53.6	50.7	69.4	64.5	59.0
FDS-249	003 576	28		44.2	60.5	56.3	51.4	48.6	66.9	61.9	56.6

Selection Chart Liquid Application

Type	Part No.	Connection Solder/ODF		Nominal Flow Capacity (KW)									
		mm	inch	Pressure Drop 0.07 bar					Pressure Drop 0.14 bar				
				R22	R134a	R507/R404A	R407C	R410A	R22	R134a	R507/R404A	R407C	R410A
FDS-245	003 573	16	5/8	75	68	49	71	74	98	90	64	93	97
FDS-247	003 574	22	7/8	112	102	73	107	110	151	139	99	144	149
FDS-249	003 575		1-1/8	113	104	74	108	112	160	147	104	153	158
FDS-249	003 576	28		114	104	74	108	112	163	150	106	156	161

Correction factors for other than the nominal conditions see next page.

Selection Chart Cores

Type	Part No.	Water Capacity in Grams at a Liquid Temperature of 24°C (52°C)			Application	Acid Adsorption capacity (g)
		R134a	R22	R404A/R507		
S24	003 504	35.2 (32.3)	34.8 (29.5)	35.4 (32.1)	Liquid and suction line	8,9
W24	003 505	12.5 (9.2)	12.3 (8.9)	13.5 (10.4)	For motor burn-out (Suction)	25,6
F24	003 506	- (-)	- (-)	- (-)	Filter for suction line	-

Cores have to be ordered separately. 1 piece needed for FDS24 shell.

Spare Parts

Description	Type	Part No.
ADKS, FDH		
Gasket Set	X 99961	003 710
Schrader Nipple 1/4" NPT	X 11562-2	803 251
Core Holder	X 99963	003 712

Description	Type	Part No.
FDS 24		
Gasket Set	X 99967	003 716
O-Ring Set	X 99968	003 717
Core Holder	X 99969	003 718

Correction Factors for Filter Driers ADK, ADKS, BFK, FDB, FDH and FDS

Filter drier selection for operating conditions other than -15°C/+30°C (R744: -40°C/-10°C):

Q_n: Nominal flow capacity
 Q₀: Required cooling capacity
 K_t: Correction factor for evaporating and liquid temperature

$Q_n = Q_0 \times K_t$

Refrigerant	Liquid Temperature °C	Correction factor K _t Evaporating Temperature °C													
		+20	+15	+10	+5	0	-5	-10	-15	-20	-25	-30	-35	-40	-45
R134a	+60	1.29	1.32	1.35	1.39	1.42	1.46	1.50	1.55	1.59	1.65	1.70			
	+55	1.20	1.22	1.25	1.28	1.31	1.34	1.38	1.41	1.45	1.50	1.54			
	+50	1.11	1.14	1.16	1.19	1.21	1.24	1.27	1.30	1.34	1.38	1.42			
	+45	1.04	1.06	1.09	1.11	1.13	1.16	1.18	1.21	1.24	1.27	1.31			
	+40	0.98	1.00	1.02	1.04	1.06	1.08	1.11	1.13	1.16	1.19	1.22			
	+35	0.93	0.94	0.96	0.98	1.00	1.02	1.04	1.06	1.08	1.11	1.14			
	+30	0.88	0.90	0.91	0.93	0.94	0.96	0.98	1.00	1.02	1.04	1.07			
	+25	0.84	0.85	0.86	0.88	0.89	0.91	0.93	0.95	0.96	0.98	1.01			
	+20		0.81	0.82	0.84	0.85	0.87	0.88	0.90	0.92	0.93	0.95			
	+15			0.79	0.80	0.81	0.83	0.84	0.85	0.87	0.89	0.90			
	+10				0.76	0.78	0.79	0.80	0.82	0.83	0.84	0.86			
	+5					0.74	0.76	0.77	0.78	0.79	0.81	0.82			
	0						0.73	0.74	0.75	0.76	0.77	0.79			
	-5							0.71	0.72	0.73	0.74	0.75			
-10								0.69	0.70	0.71	0.72				
R404A	+60	1.77	1.83	1.90	1.97	2.06	2.16	2.27	2.39	2.54	2.70	2.89	3.12	3.39	3.70
	+55	1.48	1.52	1.56	1.62	1.67	1.74	1.81	1.90	1.99	2.09	2.21	2.34	2.50	2.67
	+50	1.28	1.31	1.34	1.38	1.43	1.47	1.53	1.59	1.65	1.73	1.81	1.90	2.00	2.11
	+45	1.13	1.16	1.18	1.21	1.25	1.29	1.33	1.38	1.43	1.48	1.54	1.61	1.68	1.76
	+40	1.02	1.04	1.06	1.09	1.12	1.15	1.18	1.22	1.26	1.30	1.35	1.40	1.46	1.52
	+35	0.93	0.95	0.97	0.99	1.01	1.04	1.07	1.10	1.13	1.17	1.20	1.25	1.29	1.34
	+30	0.86	0.87	0.89	0.91	0.93	0.95	0.97	1.00	1.03	1.06	1.09	1.12	1.16	1.20
	+25	0.80	0.81	0.83	0.84	0.86	0.88	0.90	0.92	0.94	0.97	1.00	1.03	1.06	1.09
	+20		0.76	0.77	0.79	0.80	0.82	0.84	0.85	0.87	0.90	0.92	0.95	0.97	1.00
	+15			0.72	0.74	0.75	0.77	0.78	0.80	0.82	0.84	0.86	0.88	0.90	0.93
	+10				0.69	0.71	0.72	0.73	0.75	0.77	0.78	0.80	0.82	0.84	0.86
	+5					0.67	0.68	0.69	0.71	0.72	0.74	0.75	0.77	0.79	0.81
	0						0.65	0.66	0.67	0.68	0.70	0.71	0.73	0.74	0.76
	-5							0.63	0.64	0.65	0.66	0.67	0.69	0.70	0.72
	-10								0.61	0.62	0.63	0.64	0.65	0.67	0.68
	-15									0.59	0.60	0.61	0.62	0.64	0.65
-20										0.56	0.57	0.58	0.59	0.61	
R507	+60	1.68	1.73	1.78	1.84	1.91	1.99	2.07	2.17	2.27	2.39	2.53	2.69	2.87	3.08
	+55	1.43	1.46	1.50	1.54	1.59	1.65	1.71	1.77	1.85	1.93	2.02	2.12	2.24	2.36
	+50	1.25	1.28	1.31	1.34	1.38	1.42	1.47	1.52	1.57	1.63	1.70	1.77	1.85	1.94
	+45	1.12	1.14	1.17	1.20	1.23	1.26	1.30	1.34	1.38	1.42	1.48	1.53	1.59	1.66
	+40	1.02	1.04	1.06	1.08	1.11	1.13	1.16	1.20	1.23	1.27	1.31	1.36	1.40	1.46
	+35	0.94	0.95	0.97	0.99	1.01	1.04	1.06	1.09	1.12	1.15	1.18	1.22	1.26	1.30
	+30	0.87	0.88	0.90	0.92	0.94	0.96	0.98	1.00	1.02	1.05	1.08	1.11	1.14	1.18
	+25	0.81	0.83	0.84	0.85	0.87	0.89	0.91	0.93	0.95	0.97	1.00	1.02	1.05	1.08
	+20		0.77	0.79	0.80	0.81	0.83	0.85	0.86	0.88	0.90	0.92	0.95	0.97	1.00
	+15			0.74	0.75	0.77	0.78	0.79	0.81	0.83	0.84	0.86	0.88	0.91	0.93
	+10				0.71	0.72	0.74	0.75	0.76	0.78	0.79	0.81	0.83	0.85	0.87
	+5					0.68	0.70	0.71	0.72	0.73	0.75	0.76	0.78	0.80	0.81
	0						0.66	0.67	0.68	0.70	0.71	0.72	0.74	0.75	0.77
	-5							0.64	0.65	0.66	0.67	0.68	0.70	0.71	0.73
	-10								0.62	0.63	0.64	0.65	0.66	0.68	0.69
	-15									0.60	0.61	0.62	0.63	0.64	0.65
-20										0.58	0.59	0.60	0.61	0.62	

Refrigerant	Liquid Temperature °C	Correction factor Kt Evaporating Temperature °C													
		+20	+15	+10	+5	0	-5	-10	-15	-20	-25	-30	-35	-40	-45
R22	+60	1.28	1.29	1.30	1.32	1.34	1.36	1.38	1.40	1.42	1.45	1.48	1.51	1.54	1.57
	+55	1.20	1.21	1.23	1.24	1.26	1.27	1.29	1.31	1.33	1.35	1.38	1.41	1.43	1.46
	+50	1.13	1.14	1.16	1.17	1.18	1.20	1.22	1.23	1.25	1.27	1.29	1.32	1.34	1.37
	+45	1.07	1.08	1.09	1.11	1.12	1.13	1.15	1.16	1.18	1.20	1.22	1.24	1.26	1.29
	+40	1.02	1.03	1.04	1.05	1.06	1.08	1.09	1.10	1.12	1.14	1.15	1.17	1.19	1.21
	+35	0.97	0.98	0.99	1.00	1.01	1.02	1.04	1.05	1.06	1.08	1.09	1.11	1.13	1.15
	+30	0.93	0.94	0.95	0.96	0.97	0.98	0.99	1.00	1.01	1.03	1.04	1.06	1.07	1.09
	+25	0.89	0.90	0.91	0.91	0.92	0.93	0.94	0.95	0.97	0.98	0.99	1.01	1.02	1.04
	+20		0.86	0.87	0.88	0.88	0.89	0.90	0.91	0.93	0.94	0.95	0.96	0.98	0.99
	+15			0.83	0.84	0.85	0.86	0.87	0.88	0.89	0.90	0.91	0.92	0.93	0.95
	+10				0.81	0.82	0.82	0.83	0.84	0.85	0.86	0.87	0.88	0.89	0.91
	+5					0.79	0.79	0.80	0.81	0.82	0.83	0.84	0.85	0.86	0.87
	0						0.76	0.77	0.78	0.79	0.80	0.81	0.82	0.83	0.84
	-5							0.74	0.75	0.76	0.77	0.78	0.79	0.80	0.81
	-10								0.73	0.73	0.74	0.75	0.76	0.77	0.78
-15									0.71	0.72	0.72	0.73	0.74	0.75	
-20										0.69	0.70	0.71	0.72	0.72	
R407C	+60	1.40	1.42	1.45	1.49	1.52	1.56	1.61	1.65	1.70	1.76	1.82			
	+55	1.27	1.29	1.32	1.35	1.38	1.41	1.44	1.48	1.52	1.57	1.61			
	+50	1.17	1.19	1.21	1.23	1.26	1.28	1.31	1.35	1.38	1.42	1.46			
	+45	1.08	1.10	1.12	1.14	1.16	1.18	1.21	1.24	1.26	1.30	1.33			
	+40	1.01	1.02	1.04	1.06	1.08	1.10	1.12	1.14	1.17	1.20	1.22			
	+35	0.95	0.96	0.98	0.99	1.01	1.03	1.05	1.07	1.09	1.11	1.14			
	+30	0.89	0.91	0.92	0.93	0.95	0.96	0.98	1.00	1.02	1.04	1.06			
	+25	0.85	0.86	0.87	0.88	0.90	0.91	0.93	0.94	0.96	0.98	1.00			
	+20		0.81	0.82	0.84	0.85	0.86	0.88	0.89	0.91	0.92	0.94			
	+15			0.79	0.80	0.81	0.82	0.83	0.85	0.86	0.88	0.89			
	+10				0.76	0.77	0.78	0.79	0.81	0.82	0.83	0.85			
	+5					0.74	0.75	0.76	0.77	0.78	0.79	0.81			
	0						0.72	0.73	0.74	0.75	0.76	0.77			
	-5							0.70	0.71	0.72	0.73	0.74			
	-10								0.68	0.69	0.70	0.71			
R410A*	+60	1.62	1.64	1.66	1.68	1.70	1.73	1.76	1.80	1.83	1.87	1.92	1.96	2.02	2.07
	+55	1.42	1.43	1.44	1.46	1.48	1.50	1.53	1.55	1.58	1.61	1.64	1.68	1.72	1.76
	+50	1.27	1.28	1.29	1.31	1.32	1.34	1.36	1.38	1.40	1.43	1.45	1.48	1.51	1.55
	+45	1.16	1.17	1.18	1.19	1.20	1.22	1.24	1.25	1.27	1.29	1.31	1.34	1.36	1.39
	+40	1.07	1.08	1.09	1.10	1.11	1.12	1.14	1.15	1.17	1.18	1.20	1.22	1.24	1.27
	+35	1.00	1.01	1.01	1.02	1.03	1.04	1.06	1.07	1.08	1.10	1.11	1.13	1.15	1.17
	+30	0.94	0.94	0.95	0.96	0.97	0.98	0.99	1.00	1.01	1.03	1.04	1.06	1.07	1.09
	+25	0.89	0.89	0.90	0.90	0.91	0.92	0.93	0.94	0.95	0.96	0.98	0.99	1.00	1.02
	+20		0.84	0.85	0.86	0.86	0.87	0.88	0.89	0.90	0.91	0.92	0.93	0.95	0.96
	+15			0.81	0.81	0.82	0.83	0.84	0.84	0.85	0.86	0.87	0.88	0.90	0.91
	+10				0.78	0.78	0.79	0.80	0.80	0.81	0.82	0.83	0.84	0.85	0.86
	+5					0.75	0.75	0.76	0.77	0.77	0.78	0.79	0.80	0.81	0.82
	0						0.72	0.73	0.73	0.74	0.75	0.76	0.76	0.77	0.78
	-5							0.70	0.70	0.71	0.72	0.72	0.73	0.74	0.75
	-10								0.68	0.68	0.69	0.69	0.70	0.71	0.72

* Do not exceed max. allowable pressure PS: ADK/FDB/BFK: 43.0 bar; ADKS/FDS: 34.5 bar (-10°C ... +65°C); FDH: 46 bar (-10°C ... +65°C)

Refrigerant	Liquid temperature °C	Correction factor k_e Evaporating temperature °C													
		+20	+15	+10	+5	0	-5	-10	-15	-20	-25	-30	-35	-40	-45
R407F	°C														
	+60	1.42	1.43	1.46	1.48	1.50	1.53	1.56	1.59	1.63	1.66	1.70	1.75	1.79	1.84
	+55	1.29	1.31	1.32	1.34	1.36	1.39	1.41	1.44	1.47	1.50	1.53	1.57	1.61	1.65
	+50	1.19	1.21	1.22	1.24	1.25	1.27	1.30	1.32	1.34	1.37	1.40	1.43	1.46	1.49
	+45	1.11	1.12	1.13	1.15	1.16	1.18	1.20	1.22	1.24	1.26	1.29	1.31	1.34	1.37
	+40	1.04	1.05	1.06	1.07	1.09	1.10	1.12	1.13	1.15	1.17	1.19	1.22	1.24	1.27
	+35	0.98	0.99	1.00	1.01	1.02	1.03	1.05	1.06	1.08	1.10	1.12	1.14	1.16	1.18
	+30	0.92	0.93	0.94	0.95	0.96	0.97	0.99	1.00	1.01	1.03	1.05	1.06	1.08	1.10
	+25	0.87	0.88	0.89	0.90	0.91	0.92	0.93	0.94	0.96	0.97	0.99	1.00	1.02	1.04
	+20		0.84	0.85	0.85	0.86	0.87	0.88	0.90	0.91	0.92	0.93	0.95	0.96	0.98
	+15			0.81	0.81	0.82	0.83	0.84	0.85	0.86	0.87	0.89	0.90	0.91	0.93
	+10				0.78	0.79	0.79	0.80	0.81	0.82	0.83	0.84	0.86	0.87	0.88
	+5					0.75	0.76	0.77	0.78	0.78	0.79	0.81	0.82	0.83	0.84
	0						0.73	0.73	0.74	0.75	0.76	0.77	0.78	0.79	0.80
	-5							0.71	0.71	0.72	0.73	0.74	0.75	0.76	0.77
	-10								0.68	0.69	0.70	0.71	0.72	0.73	0.74
-15									0.67	0.67	0.68	0.69	0.70	0.71	
-20										0.65	0.66	0.66	0.67	0.68	

Refrigerant	Liquid Temperature °C	Correction factor k_t Evaporating Temperature °C													
		+5	0	-5	-10	-15	-20	-25	-30	-35	-40	-45	-50		
R744*	+10	1.37	1.35	1.33	1.32	1.31	1.31	1.31	1.31	1.31	1.32	1.33	1.34		
	+5		1.24	1.23	1.22	1.21	1.21	1.21	1.21	1.21	1.22	1.22	1.23		
	0			1.14	1.13	1.13	1.12	1.12	1.13	1.13	1.13	1.14	1.15		
	-5				1.06	1.06	1.05	1.05	1.05	1.06	1.06	1.07	1.07		
	-10					1.00	0.99	0.99	0.99	1.00	1.00	1.00	1.01		
	-15						0.94	0.94	0.94	0.94	0.95	0.95	0.96		
	-20							0.89	0.89	0.90	0.90	0.90	0.91		
	-25								0.85	0.85	0.86	0.86	0.87		
	-30									0.82	0.82	0.82	0.83		
	-35										0.78	0.79	0.79		
	-40											0.76	0.76		
	-45												0.73		

* Do not exceed max. allowable pressure PS: ADK/FDB/BFK: 43.0 bar; ADKS/FDS: 34.5 bar (-10°C ... +65°C); FDH: 46 bar (-10°C ... +65°C)

Suction Line Filters and Filter Driers Series ASF and ASD

Hermetic Design

Features

- Minimum pressure drop due to internal construction and compacted bead style
- Service-friendly with 2 Schrader valves for pressure drop measurement
- ODF Copper fittings for easy soldering
- Filtration down to 40 microns
- Temperature range TS: -45°C to +50°C
- Max. allowable pressure PS: 27,5 bar
- No CE marking according art. 3.3 PED 97/23 EC
- HP marking according to German Pressorized Vessel Directive



ASF, ASD

Suction Line Filters

Type	Part No.	Connection Solder/ODF		Nominal Capacity Qn kW				
		mm	inch	R134a	R22	R404A	R407C	R507
ASF-28 S3	008 965		3/8	6.0	8.4	7.7	7.8	7.7
ASF-28 S4	008 941		1/2	9.9	14.4	13.4	13.4	13.4
ASF-35 S5	008 915	16	5/8	15.9	23.2	21.4	21.6	21.4
ASF-45 S6	008 946		3/4	23.3	34.5	32.0	32.1	32.0
ASF-45 S7	008 904	22	7/8	32.5	42.5	34.5	39.5	34.5
ASF-50 S9	008 908		1 1/8	46.0	67.1	55.5	62.4	55.5
ASF-75 S11	008 919	35	1 3/8	60.2	85.4	70.7	79.4	70.7
ASF-75 S13	008 940		1 3/8	65.4	87.5	73.1	81.4	73.1

Suction Line Filter Driers

Type	Part No.	Connection Solder/ODF		Nominal Capacity Qn kW				
		mm	inch	R134a	R22	R404A	R407C	R507
ASD-28 S3	008 909		3/8	5.5	8.1	7.4	7.5	7.4
ASD-28 S4	008 910		1/2	9.1	13.4	12.7	12.5	12.7
ASD-35 S5	008 899	16	5/8	14.3	20.4	19.0	19.0	19.0
ASD-45 S6	008 925		3/4	19.1	24.6	22.5	22.9	22.5
ASD-45 S7	008 896	22	7/8	25.0	32.3	26.4	30.0	26.4
ASD-50 S9	008 881		1 1/8	35.3	46.4	38.3	43.2	38.3
ASD-75 S11	008 891	35	1 3/8	42.9	56.9	47.8	52.9	47.8
ASD-75 S13	008 953		1 3/8	45.2	60.8	51.0	56.5	51.0

Nominal flow capacity at +4°C evaporating temperature (saturated condition/dew point) and a pressure drop of 0.21 bar between inlet and outlet of ASF/ASD. Correction factor for other evaporating temperatures than +4°C:

$$Q_n = Q_o \times K_s$$

- Q_n : Nominal capacity
 K_s : Correction factor for a pressure drop corresponding 1 K saturation temperature
 Q_o : Required cooling capacity

Evaporating Temperature (°C)	+4	0	-5	-10	-15	-20	-25	-30	-35	-40
Correction Factor kt	1.00	1.12	1.35	1.75	2.00	2.50	3.00	3.75	5.00	6.60

Water and Acid Adsorption Capacity

Type	Water Adsorption Capacity (gram)										Acid Adsorption Capacity (g)
	Liquid Temperature 24°C					Liquid Temperature 52°C					
	R134a	R22	R404A R507	R407C	R410A	R134a	R22	R404A R507	R407C	R410A	
ASD-28	11.8	5.7	12.2	9.1	8.0	10.0	3.6	9.7	6.7	5.6	3.0
ASD-35	14.5	7.0	15.0	11.2	9.9	12.3	4.4	12.0	8.2	6.9	3.6
ASD-45	18.0	8.8	18.6	13.9	12.3	15.3	5.5	14.9	10.2	8.6	4.5
ASD-50	21.4	10.4	22.2	16.5	14.6	18.2	6.5	17.7	12.1	10.2	5.4
ASD-75	31.5	15.4	32.6	24.3	21.5	26.7	9.6	26.0	17.8	15.0	7.9

Suction Line Filter and Filter Drier Shells Series BTAS

for replaceable Filters and Filter Drier Cores

Features

- Corrosion-free brass body ideal for suction line applications
- Extremely large filtration area for optimum flow capacity
- Low pressure drop
- Filtration down to 40 micron
- Temperature range TS: -45°C ... +50°C
- Max. allowable pressure PS: 24 bar
- UL/CUL file number: SA 3124



Suction Line Shells with Filter Core (please order separately)

Type	Part No.	Connection Solder/ODF		Nominal Capacity Qn kW					Filter Core	
		mm	inch	R134a	R22	R404A	R407C	R507	Type	Part No.
No CE marking according to art. 3.3 PED 97/23. HP marking according to German pressurised vessel directive										
BTAS 25	015 353		5/8	12.5	17.1	13.9	15.9	13.9	A2F	009 907
BTAS 27	015 354	22	7/8	22.3	29.6	24.3	27.5	24.3		
BTAS 39	015 355		1 1/8	37.7	50.4	40.6	46.9	40.6	A3F	009 909
BTAS 311	015 356	35	1 3/8	60.3	80.7	65.2	75.1	65.2		
BTAS 313	015 357		1 5/8	73.4	97.5	81.1	90.7	81.1		
BTAS 342	015 358	42		73.4	97.5	81.1	90.7	81.1		
BTAS 317	015 359	54	2 1/8	97.6	127.7	104.8	118.8	104.8	A4F	009 911
BTAS 417	015 360	54	2 1/8	134.7	178.2	145.3	165.7	145.3		
CE marked, Conformity assessment cat. I, procedure module A										
BTAS 521	015 361		2 5/8	209.0	282.4	229.8	262.6	229.8	A5F	009 913
BTAS 525	015 362		3 1/8	260.1	346.1	283.9	321.9	283.9		
BTAS 580	015 363	80		260.1	346.1	283.9	321.9	283.9		

Filter Core has to be ordered separately.

Suction Line Shells with Filter Drier Core (please order separately)

Type	Part No.	Connection Solder/ODF		Nominal Capacity Qn kW					Filter Drier Core	
		mm	inch	R134a	R22	R404A	R407C	R507	Type	Part No.
No CE marking according to art. 3.3 PED 97/23. HP marking according to German pressurised vessel directive										
BTAS 25	015 353		5/8	11.6	15.5	12.8	14.3	12.8	A2F-D	009 908
BTAS 27	015 354	22	7/8	19.1	25.2	20.6	23.4	20.6		
BTAS 39	015 355		1 1/8	34.4	45.7	37.5	42.5	37.5	A3F-D	009 910
BTAS 311	015 356	35	1 3/8	49.2	65.5	53.7	60.9	53.7		
BTAS 313	015 357		1 5/8	57.1	77.3	62.5	71.9	62.5		
BTAS 342	015 358	42		57.1	77.3	62.5	71.9	62.5		
BTAS 317	015 359	54	2 1/8	77.1	94.1	77.7	87.5	77.7	A4F-D	009 912
BTAS 417	015 360	54	2 1/8	106.8	144.5	118.3	134.4	118.3		
CE marked, Conformity assessment cat. I, procedure module A										
BTAS 521	015 361		2 5/8	153.3	205.1	169.0	190.7	169.0	A5F-D	009 914
BTAS 525	015 362		3 1/8	181.2	242.0	199.4	225.1	199.4		
BTAS 580	015 363	80		181.2	242.0	199.4	225.1	199.4		

Filter Drier Core has to be ordered separately.

Nominal capacity at +4°C evaporating temperature (saturated condition/ dew point) and a pressure drop of 0.21 bar between inlet and outlet of BTAS. Correction factor for other evaporating temperatures than +4°C:

$$Q_n = Q_o \times K_s$$

Q_n : Nominal capacity
 K_s : Correction factor for a pressure drop corresponding 1K saturation temperature
 Q_o : Required cooling capacity

Evaporating Temperature (°C)	+4	0	-5	-10	-15	-20	-25	-30	-35	-40
Correction Factor K_s	1.00	1.12	1.35	1.75	2.00	2.50	3.00	3.75	5.00	6.60

BTAS - Water and Acid Adsorption Capacity

Core	Water Adsorption Capacity (gram)								Acid Adsorption capacity (g)
	Liquid Temperature 24°C				Liquid Temperature 52°C				
	R134a	R22	R404A R507	R407C	R134a	R22	R404A R507	R407C	
A2F-D	2.8	2.5	2.9	4.8	2.3	1.9	2.3	5.0	3.7
A3F-D	7.6	6.8	8.0	13.3	6.3	5.3	6.2	13.8	10.3
A4F-D	14.8	13.3	15.7	25.9	12.2	10.3	12.2	26.9	20.1
A5F-D	21.8	19.6	23.1	38.2	18.0	15.1	17.9	39.7	29.6

Spare parts

Repair Kits with cover, screws and gaskets	Type	Part No.
Repair kit BTAS 2	KD 30519-2	065 970
Repair kit BTAS 3	KD 30519-3	065 971
Repair kit BTAS 4	KD 30519-4	065 972
Repair kit BTAS 5	KD 30519-5	065 973

Moisture / Liquid Indicators Series MIA and CIA

Features

- MIA for HFC & CO₂, Max. allowable pressure 45 bar
- CIA for HFC & CO₂, Max. allowable pressure 60 bar
- Fully hermetic
- Corrosion-resistant stainless steel body
- Crystal indicator element for long lifetime and reliability
- Indication of dryness according to ASERCOM recommendation
- Easy determination of moisture content
- Sensitive indicator with calibrated four colours
- Large clear viewing area
- Lightweight
- ODF extended tube configurations suitable for all commercial applications
- UL certified for Canada, see SA 4876 (MIA only, except MIA-078)



Selection Chart

Type	Part No.	for Tube Outside Ø	Height A (mm)	Length B (mm)	Weight (g)
MIA 014	805 883	¼"	25.7	98.0	60
MIA 038	805 884	⅜"	28.5	109.0	70
MIA 012	805 885	½"	31.8	113.0	75
MIA 058 / MIA M16	805 886	⅝" / 16mm	31.8	108.5	85
MIA 078	805 887	⅞"	37.8	122.5	150
MIA 118	805 892	1 ⅛"	43.5	122.5	190

MIA M06	805 880	6 mm	25.9	98.0	60
MIA M10	805 881	10 mm	28.5	109.0	70
MIA M12	805 882	12 mm	28.5	113.0	75
MIA M28	805 891	28 mm	43.5	122.5	190
MIA M10 S Female/Male	805 888	10 mm	28.7	119.0	75
MIA M12 S Female/Male	805 889	12 mm	28.5	113.0	75

CIA 014	805910	1/4"	25,7	98,0	60
CIA 038	805911	3/8"	28,5	109,0	70
CIA 012	805912	1/2"	31,8	113,0	75
CIA 058 / M16	805913	5/8" or 16mm	31,8	108,5	85

CIA M06	805914	6mm	25,9	98,0	60
CIA M10	805915	10mm	28,5	109,0	70
CIA M12	805916	12mm	28,5	113,0	75

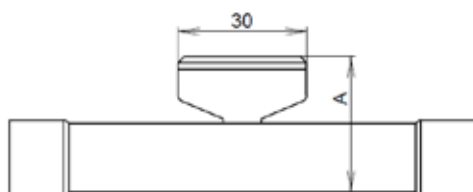

Water Contents* by Indicator Color

Refrigerant	Liquid Temperature °C	blue: dry	purple	fushia: Caution	rose: Caution - wet
R22	+25	25	40	80	145
	+38	35	65	130	105
	+52	50	90	185	290
R404/R507	+25	15	33	60	120
	+38	25	50	110	150
	+52	45	60	140	180
R134a	+25	20	35	90	130
	+38	35	55	120	160
	+52	50	85	150	190
R407C	+25	26	42	94	151
	+38	40	68	144	232
	+52	64	109	230	371
R410A	+25	30	50	110	165
	+38	55	85	190	290
	+52	75	120	270	420
R744	-40	3	5	10	16
	-20	6	10	20	32
	-10	8	14	29	46
	0	11	19	39	63
	+5	13	22	46	75
	+20	20	34	72	116

* Water content in mg Water per kg refrigerant (ppm)

Moisture / Liquid Indicators Series AMI

Features

- First choice for R134a, R22, R404A, R407C, R507 and polyolester lubricants
- High accuracy of moisture indication according to ASERCOM recommendation
- Fused glass - no leakage
- Long lifetime of indicators by utilization of crystals
- Indicator with high resistance against acid and water
- Wide angle view for exact distinction of vapor and liquid
- Max. allowable pressure PS: 31 bar



AMI-1 SS



AMI-1 TT



AMI-3

Selection Chart

Type		Part No.	Connection		Configuration
			mm	inch	
AMI-1	SS 2 MM	805 732	6		Female solder x female solder ODF x ODF
	SS 2	805 713		¼	
	SS 3 MM	805 733	10		
	SS 3	805 714		⅜	
	SS 4 MM	805 734	12		
	SS 4	805 715		½	
	SS 5	805 716	16	⅝	
	SS 7	805 717	22	⅞	
	SS 9 MM	805 703	28		
	SS 9	805 705		1 ⅛	
	TT 2 MM	805 697	6		Female solder x female solder ODF x ODF (with extended copper tubes)
	TT 2	805 655		¼	
	TT 3 MM	805 698	10		
	TT 3	805 654		⅜	
	TT 4 MM	805 699	12		
	TT 4	805 653		½	
	TT 5	805 652	16	⅝	
	TT 7	805 656	22	⅞	
	TT 9 MM	805 700	28		
	TT 9	805 651		1 ⅛	
AMI-1	MM 2	805 706	6	¼	Male flare x male flare
	MM 3	805 707	10	⅜	
	MM 4	805 708	12	½	
	MM 5	805 709	16	⅝	
	FM 2	805 710	6	¼	
FM 3	805 711	10	⅜		
FM 4	805 712	12	½		
AMI-2	S 11	805 704	35	1 ⅜	Male solder ODM (for soldering into fittings)
	S 13	805 659	42	1 ⅝	
	S 17	805 687	54	2 ⅛	
AMI-3	S 7	805 650	22	⅞	Saddle type (for soldering onto the pipe)
	S 9	805 649	28	1 ⅛	
	S 11	805 648	35	1 ⅜	

Water Contents* by Indicator Color

Refrigerant	Liquid Temperature °C	blue: dry	purple	fushia: Caution	rose: Caution - wet
R22	25	25	40	80	145
	38	35	65	130	205
	52	50	90	185	290
R404/R507	25	15	33	60	120
	38	25	50	110	150
	52	45	60	140	180
R134a	25	20	35	90	130
	38	35	55	120	160
	52	50	85	150	190
R407C	25	26	42	94	151
	38	40	68	144	232
	52	64	109	230	371

* Water content in mg Water per kg refrigerant (ppm)

Accessories

	Type	Part No.
Lens assembly kit	X 12978-1	805 742
O-Ring	x 99995	805 643

Oil Management Components

Oil Management Components

Technical Information

Refrigeration compressors are lubricated by refrigeration oil that circulates from the compressor crankcase or housing. As refrigerant gas is discharged by the compressor, it will leave a fine oil mist that will be circulated throughout the entire system. Small amounts of oil circulating through the system will not affect the system performance. Too much refrigeration oil circulating in the system will have adverse effects on the components in the system. Circulating oil reduces the ability of the system to effectively remove the heat. Condensers, evaporators and other heat exchangers lose efficiency when coated internally with an oil film.

Oil not returning to the compressor causes improper lubrication and eventual compressor failure. At low temperature application, oil thickness becomes difficult to move, causing oil to be trapped in the system.

Oil Separator Function

Refrigerant gas leaving the compressor through the discharge line contains refrigeration oil in a vaporous mist. As this mixture enters the oil separator, the velocity is reduced to allow oil separation to begin.

The refrigerant gas and oil mixture enters the oil separator and passes through an inlet screen, causing the fine particles to combine. Larger oil particles are formed and drop to the bottom of the oil separator.

The refrigerant gas then passes through an outlet screen to remove residual oil particles. The oil gathers in the bottom of the oil separator until a float operated needle valve opens to allow the return of oil to the compressor. Oil returns quickly to the compressor, because of the higher pressure in the oil separator than in the compressor crankcase. When the oil level has lowered, the needle valve retracts to prevent refrigerant gas from returning back to the compressor. The refrigerant gas leaves through the outlet of the oil separator and goes to the condenser.

Oil Level Management System Function

This system provides oil level balancing as well as oil level monitoring including alarm and compressor shut-down functions. The oil level is measured inside the compressor's crankcase. By operating an integrated solenoid valve, missing oil can be fed from the oil receiver or from the oil separator directly into the compressor sump. If the oil level drops to a dangerous level, the alarm contact changes into alarm state. The alarm contact may be used to shut down the compressor. The integrated electronics include delay times in order to avoid short-cycling and nuisance alarms.

This system applies to compressor pack applications with multiple parallel compressor arrangements, but also to stand-alone compressor applications for compressors without differential oil pressure monitoring.

Electronic Oil Level Management Systems OM3 / OM4 TraxOil™

With Alarm Function and Compressor Shut Down

Features

- OM4 series for CO₂ and R410A, OM3 for HFC refrigerants
- IP65 rating due to molded housing and electrical connection with molded cable assemblies
- 3 Zone Level Control by using precise Hall-sensor measurement, not prone to errors by foaming or light like optical sensors
- Self-contained unit with oil level sensor and integral solenoid valve to manage oil level supply
- SPDT output contact for compressor shut-down or alarming, rating 230 VAC/3A
- Supply 24VAC or 230VAC
- Alarm, status and 3-zone level indication by LEDs
- Easy installation by sightglass replacement and frontside installation without nuts
- Visual inspection of oil level still possible
- Adapters suitable for various types of compressors
- Recommended by leading compressor manufacturers
- **CE** marking under Low Voltage and EMC Directive



OM4 with 24V supply



OM4 with OM-230V

Product Selection (select one item of each group)

1. Base Units (supplied without adapter and coil)

Type	Part No.	Max. working pressure	Time delay alarm
OM3-020	805 133	35 bar	20 sec
OM3-120	805 134		120 sec
OM4-020	805 135	60 bar	20 sec
OM4-120	805 136		120 sec

2. Adapter flanges

OM0-CUA	805 037	Flange adapter 3- / 4-hole
OM0-CBB	805 038	Screw adapter 1-1/8"-18 UNEF
OM0-CCA	805 039	Screw adapter 3/4"-14 NPTF
OM0-CCB	805 040	Screw adapter 1-1/8"-12 UNF
OM0-CCC	805 041	Flange adapter 3-hole
OM0-CCD	805 042	Rotalock adapter 1-3/4"-12UNF
OM0-CCE	805 043	Rotalock adapter 1-1/4"-12UNF

3. Cables Alarm Relay

OM3-N30	805 141	Connection to Relay 3.0m
OM3-N60	805 142	Connection to Relay 6.0m
OM3-N100	805 146	Connection to Relay 10.0m

Supply voltage 24V

4. Solenoid Coil

Type	Part No.	
ASC3-24VAC	801 079	50/60 Hz, 15 VA

5. Cable Assembly Power Supply and Solenoid

OM3-P30	805 151	24V, 3.0m
OM3-P60	805 152	24V, 6.0m
OM3-P100	805 153	24V, 10.0m

Supply voltage 230V

4. Solenoid Coil

Type	Part No.	
ASC3-230VAC	801 077	50/60 Hz, 15 VA

5. Cable Assembly Power Supply and Solenoid

OM-230V-3	805 161	230V, 3.0m
OM-230V-6	805 162	230V, 6.0m

Adapter Selection Guideline

		Compressor series with OM3:	Compressor series with OM4: OM4 can be incorporated in compressors designed for CO ₂ transcritical in conjunction with oil receivers/reservoirs up to 60bar
OM0-CUA PartNo. 805037 Flange adapter 3- / 4-hole	Arctic Circle	G2, G4, G6	
	Bitzer	4VC, 4TC, 4PC, 4NC, 4J, 4H, 4G, 6J, 6H, 6G, 6F, 8GC, 8FC	4- VHC-10K, THC-12K, PHC-15K, NHC-20K, VSL-15K, TSL-20K, PSL-25K, NSL-30K
	Bock	HA, HG (except HG/HA-34/22, see-CBB), O-Series	HGX4/310-4, 385-4, 464-4, 555-4
	Copeland	4M & 6M (except transcritical 4MTL models), D2, D3, D4, D6, D9, 4CC, 6CC, ZBH	
	Dorin	all KP, K sizes (except those mentioned under-CBB)	SCC 250/300/350/380/500/750/1500/1900/2000/2500/ -B, SCS 340/351/362/373/385/3K8/-D
	Frascold	Series A, B, D, F, S, V, W, Z	A-SK, D-SK, F-SK, Q-SK, S-SK
OM0-CBB PartNo. 805038 Screw adapter 1-1/8"-18 UNEF	Bitzer	2KC, 2JC, 2HC, 2GC, 2FC, 2EC, 2DC, 2CC, 4FC, 4EC, 4DC, 4CC	2- KHC-05K/ JHC-07K/ HHC-2K/ GHC-2K/ FHC-3K/ EHC-3K/ DHC-3K/ CHC-4K, MHC-05K, KSL-1K/ JSL-2K/ HSL-3K/ GSL-3K/ FSL-4K/ ESL-4K/ DSL-5K/ CSL-6K/ MSL-7K, 4- CHC-9K/ DHC-7K/ EHC-6K/ FHC-5K MTC, KTC, JTC-10K & 15K, HTC-15K & 20K, FTC-20K & 30K
	Bock	HA12/22/34, HG12/22/34	HGX12P/40-4, 50-4, 60-4, 75-4 HGX22P110-4, 125-4, 160-4, 190-4 HGX34P215-4, 255-4
	Copeland		4MTL, 4MSL
	Dorin	all H, K100CC/CS, K150CC/CS, K180CC/CS, K200CC, K230CS, K235CC, K240SB, K40CC, K50CS, K75CC/CS-	
	L'Unite Herm.	TAH, TAG	
	Maneurop	LT, MT, SM, SZ	
OM0-CCA PartNo. 805039 Screw adapter 3/4"-14 NPTF	Bitzer	ZL, ZM	
	Copeland	ZB15 to ZB48 - until 06/2014 ZBD21 to ZBD45 - until 06/2014 ZB56, 75, 92, 11 - until 05/2012 ZF06 to ZF25 - until 06/2014 ZF24 to ZF48 * - until 05/2012 ZS21 to ZS45 - until 06/2014 ZS56 to ZS11 - until 05/2012	ZO34 to ZO104 - until 06/2014 ZOD34 to ZOD104- until 06/2014
OM0-CCB PartNo. 805040 Screw adapter 1-1/8"-12 UNF	Copeland	DK, DL	
OM0-CCC Part No. 805041 Flange adapter 3-hole	Copeland	D8D, D8S_ (except D8SJ) and D8SK, installation only on one sight glass)	
OM0-CCD PartNo. 805042 Rotalock adapter 1-3/4"-12 UNF	Copeland	ZB220, ZH, ZR 90, 11, 12, 16, 19 ZR250 to ZR380, ZF 24 to ZF 48, ZS 56 to ZS 11	ZP 180, ZP 235 to ZP 485
OM0-CCE PartNo. 805043 Rotalock adapter 1-1/4"-12 UNF	Copeland	ZB15 to ZB48 - after 06/2014 ZB50, 58, 66, 76, 95, 114 ZBD21 to ZBD45 - after 06/2014 ZF06 to ZF25 - after 06/2014* ZF(D)18 - after 06/2014 ZR94/108/125/144/160/190 ZS21 to ZS45 - after 06/2014	ZP90/103/120/137/154/182 ZO21, ZO34 to ZO104 - after 06/2014 ZOD34 to ZOD104 - after 06/2014
	Bitzer		GSD60182 to 60235 GSD80182, 80235, 80295 to 80485

**) Digital or Enh. Vapor Inj. variations of standard models have the same sight glass/ will use the same adaptor as the standard model. Other adaptor types on request!*

Oil Management Kits including adapter and 24V Coil: cross reference

Kit inc. Adapter	Part No.	⇒	Base Unit	Part No.	Adapter	Part No.	Coil	Part No.
OM3-CUA	805030		OM3-020	805133	OM0-CUA	805037	ASC3 24 VAC	801 079
OM3-CBB	805032				OM0-CBB	805038		
OM3-CCA	805033				OM0-CCA	805039		
OM3-CCB	805034				OM0-CCB	805040		
OM3-CCC	805035				OM0-CCC	805041		
OM3-CCD	805031				OM0-CCD	805042		
OM3-CCE	805029				OM0-CCE	805043		

Kit inc. Adapter	Part No.	⇒	Base Unit	Part No.	Adapter	Part No.	Coil	Part No.
OM4-CUA	805060		OM4-020	805135	OM0-CUA	805037	ASC3 24 VAC	801 079
OM4-CBB	805062				OM0-CBB	805038		
OM4-CCA	805063				OM0-CCA	805039		
OM4-CCB	805064				OM0-CCB	805040		
OM4-CCC	805065				OM0-CCC	805041		
OM4-CCD	805061				OM0-CCD	805042		
OM4-CCE	805066				OM0-CCE	805043		

Accessories

ECT-323	804 424	Transformer 230VAC / 24VAC, 25VA (supply of 1 pc. OM3/OM4)
ECT-623	804 421	Transformer 230VAC / 24VAC, 60VA (supply of 3 pcs. OM3/OM4)
ODP-33A	800 366	Differential oil check valve 3.5 bar, inlet 15/16 -18UNF female, outlet 5/8 -18UNF male, PS 46 bar, OM3 only

Technical Data

Supply voltage / total power	OM3/4 with 24VAC ASC3 coil. 24VAC, 50/60Hz, +10/-15%, 17VA OM3/4 with OM-230V-x module. 230VAC, 50/60 Hz, 17VA
Maximum allowable pressure PS	OM3: 35 bar, OM4: 60 bar
Solenoid valve MOPD	OM3: 21 bar, OM4: 30 bar
Medium temperature	-20 to 80°C
Ambient/Storage Temperature	-20 to 50°C
Time delay filling	10 s
Time delay alarm	20 s, OM3/OM4-120: 120 s

Body material	Aluminum
Screw material	Stainless Steel
Medium compatibility	HCFC, HFC, CO ₂ , mineral, synthetic, and ester lubricants
Orientation of base unit	horizontal
Level Control	40 to 60% of sightglass height
Protection class	IP 65 (IEC529/EN 60529)
Weight	850 ... 930g (dep. on adapter)
Alarm contact	max. 3A, 230VAC, SPDT dry contact

Application

Traditional low pressure oil level management system

- | | |
|--------------------------------|-------------------------------|
| 1: Differential pressure valve | 5: Common Discharge |
| 2: Oil reservoir | 6: Common Suction Normal Temp |
| 3: Condenser | 7: Suction Line Low Temp |
| 4: Filter Drier | 8: Oil Separator |

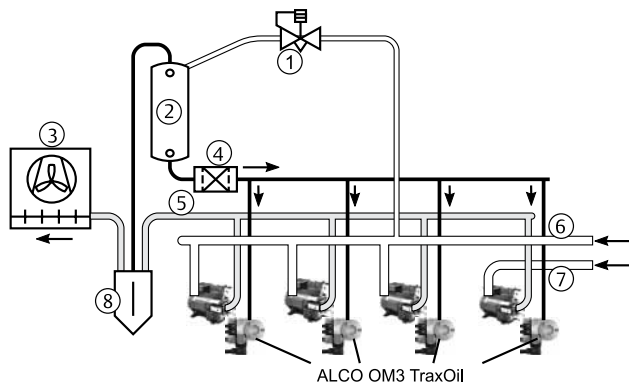

High pressure oil level management system

- | | |
|---------------------|------------------|
| 1: Common Suction | 4: Filter Drier |
| 2: Common Discharge | 5: Oil Separator |
| 3: Condenser | |

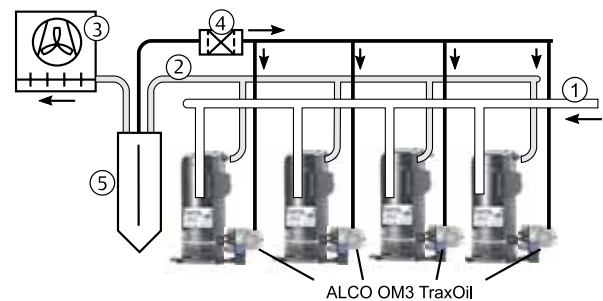

Electronic Oil Level Management Systems OM5 TraxOil™

OM5 TraxOil is developed and specially optimized for CO₂ systems, where max. working pressures above 60 bar up to 130 bar are required. OM5 is capable to feed oil in subcritical and transcritical compressors.

Like all other TraxOil oil management systems OM5 is a self-contained system which provides both functions of oil level monitoring and active oil level balancing including alarm relay activation for compressor protection.

Features

- Suitable for R744 (CO₂) transcritical
 - max. working pressure 130 bar
 - max. operating pressure differential 100 bar
- Supply 24VAC or 230VAC
- High wattage ASC3 coil specially designed for OM5
- Self contained unit with oil level sensor and integral solenoid to manage oil level supply
- 3-zone level control by using precise hall sensor measurement, not prone to errors by foaming or light like optical sensors
- SPDT output contact for compressor shut down or alarming, rating 230VAC / 3A
- Easy installation by sight glass replacement and front side mounting without nuts
- Alarm, status and level indication by LED's



OM5 with 24V supply

Product Selection (select one item of each group)

1. Base Units (supplied without adapter and coil)

Type	Part No.	Max. working pressure	Time delay alarm
OM5-120	805231	HP side: 130 bar	120 sec

2. Adapter flanges

OM0-CUA	805037	Flange adapter 3- / 4-hole
OM0-CCC	805041	Flange adapter 3-hole
OM0-CUD	805049	Flange adapter 6- / 6-hole
OM0-CBB	805038	Screw adapter 1-1/8"-18 UNEF
OM0-CCA	805039	Screw adapter 3/4"-14 NPTF
OM0-CCB	805040	Screw adapter 1-1/8"-12 UNF
OM0-CCD	805042	Rotalock adapter 1-3/4"-12UNF
OM0-CCE	805043	Rotalock adapter 1-1/4"-12UNF

Supply voltage 24V

4. Solenoid Coil

Type	Part No.	
ASC3-W24 VAC	801074	50/60 Hz, 38 VA

5. Cable Assembly Power Supply and Solenoid

OM3-P30	805151	24V, 3.0m
OM3-P60	805152	24V, 6.0m
OM3-P100	805153	24V, 10.0m

Supply voltage 230V

4. Solenoid Coil

Type	Part No.	
ASC3-W230 VAC	801075	50/60 Hz, 38 VA

5. Cable Assembly Power Supply and Solenoid

OM-230V-3	805161	230V, 3.0m
OM-230V-6	805162	230V, 6.0m

Adapter Selection Guideline (intended only for connectivity of adapter to compressor series)

		Compressor series
OM0-CUA Part No. 805037 Flange adapter 3- / 4-hole		
OM0-CBB Part No. 805038 Screw adapter 1-1/8"-18 UNEF	Bitzer	4 - CTC, DTC, FTC, HTC, JTC, KTC, MTC, PTC
	Bock	HAX2...CO2 T HGX2 ...CO2 T HGX34...CO2 T HGX46...CO2 T
	Copeland	4MSL, 4MTL
OM0-CCA Part No. 805039 Screw adapter 3/4"-14 NPTF		
OM0-CCB Part No. 805040 Screw adapter 1-1/8"-12 UNF		
OM0-CCC Part No. 805041 Flange adapter 3-hole		
OM0-CCD Part No. 805042 Rotalock adapter 1-3/4"-12 UNF		
OM0-CCE Part No. 805043 Rotalock adapter 1-1/4"-12UNF		
OM0-CUD Part No. 805049 Flange adapter 6- / 6-hole	Dorin	CD2S-200 CD2S-400 CDxx B CDxx H CDxx M

*) Digital/Enhanced Vapor Injection versions of standard models have the same sight glass/ will use the same adaptor as the standard model.
Other adapter types on request!

Our application engineering's advice and the information contained in this guideline are based on experience and are made to the best of our knowledge and belief, they must be regarded however as non-binding advice without guarantee.

Accessories and Spare Parts

Type	Part No.	Description	Weight
ECT-623	804 421	Transformer 230 VAC / 24VAC, 60 VA	1.20 kg
ASC3-K01	801 080	Retainer Kit ASC3 inc. o-rings	0.10 kg
OM5-K01	805 067	Repair Kit (consists of all necessary o-rings, oil adapter with strainer, sight glass, screws)	0.26 kg

Technical Data

CE marked under: Low Voltage Directive EMC Directive	2006/95/EC 89/336/EC
Applied Standards	EN 12284, EN 378, EN 61010, EN 50081-1, EN 50082-1
Max. working pressure PS: Max. test pressure PT: Burst Pressure:	HP side: 130 bar LP side: 100 bar 143 bar 390 bar
Supply voltage / total power: • with ASC3-W24VAC coil • with ASC3-W230VAC coil and OM-230V-x module	24VAC, 50/60Hz, +10/-10%, 38VA 230VAC, 50/60 Hz, +10/-10%, 38VA
Vibration resistance (EN60068-2-6)	max. 4g, 10...250Hz
Medium temperature Ambient/Storage temperature	-20 to 80°C -20 to 50°C
Medium compatibility	HCFC, HFC, CO ₂ , mineral, synthetic and ester lubricants

Materials: Body and Adaptor Screws Sight Glass	aluminum (EN AW 6060) galvanized steel galvanized steel (ISO 2081)
Oil Flow rate	See Fig. 1
Orientation of base unit: Level control:	horizontal, +/- 1° 40% to 60% sight glass height
Alarm contact:	max. 3A, 230VAC SPDT dry contact
Time Delay Alarm:	120 sec
Time Delay Filling:	10 sec.
Protection class	IP 65 (DIN / EN 60529)
Weight: 24V System 230V System	750 ... 950g inc. adaptor 1100 ... 1290g inc. adaptor
Oil connection	7/16"-20 UNF male, with strainer and O-ring (replaceable, see acc.)

Fig. 1: Performance related to supply voltage:
Flow Rate and Differential Pressure between inlet and outlet
(Oil type Renisco C85E, oil temperature 54°C)

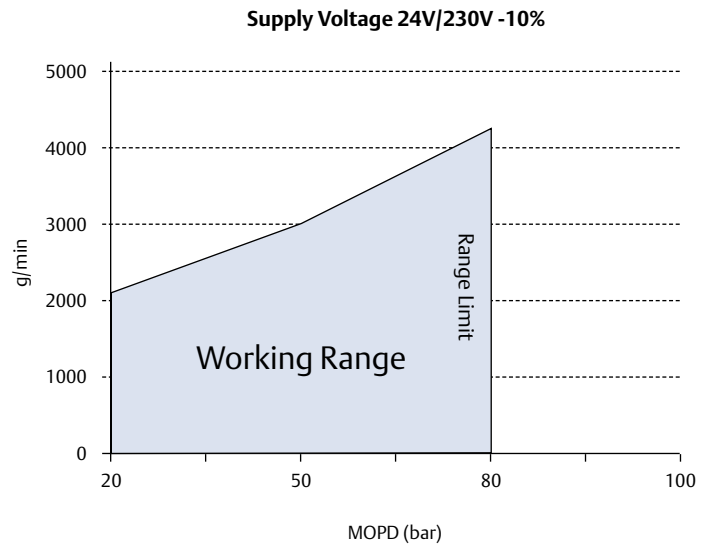
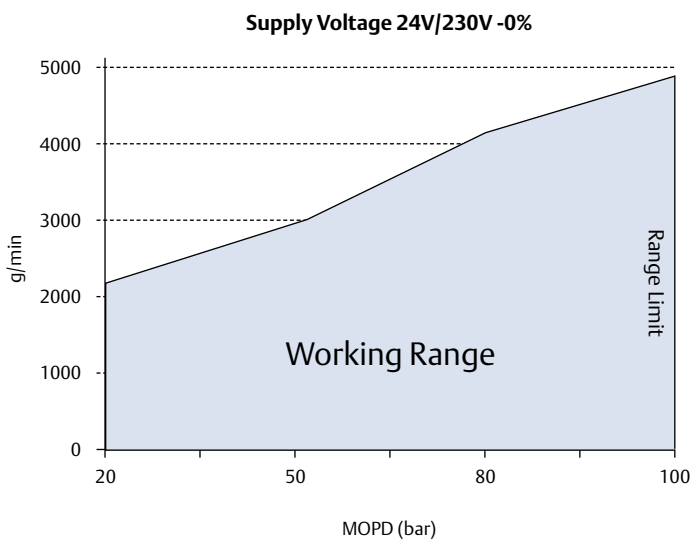

Electronic Oil Level Monitoring TraxOil™ OW4 and OW5

OW4 and OW5 TraxOil are intended for systems which require oil level monitoring and alarming instead of active oil level balancing.

Features

- OW5 for CO₂ transcritical (MWP 100 bar)
- OW4 for HFC refrigerants and subcritical CO₂ (MWP 60 bar)
- IP65 rating due to molded housing and new electrical connection with molded cable assemblies
- 3-zone level control by using precise hall sensor measurement, not prone to errors by foaming or light like optical sensors
- CE marking under Low Voltage and EMC Directive
- SPDT output contact for compressor shut-down or alarming, rating 230VAC / 3A
- Easy installation by sight-glass replacement and front-side mounting without nuts
- Self-contained unit with oil level sensor
- Alarm, status and 3 zone indication by LEDs
- Supply 24V AC, 50/60Hz
- Adapters suitable for various types of compressors
- Recommended by leading compressor manufacturers



TraxOil OW5

Selection (select one item of each group)

1. Base Unit (supplied without adapter)

Type	Part No.	Max. working pressure	Time delay alarm
OW4-020	805 116	60 bar	20 sec
OW5-120	805 241	100 bar	120 sec

2. Adapter flanges

OM0-CUA	805 037	Flange adapter 3-/4-hole
OM0-CBB	805 038	Screw adapter 1-1/8"-18 UNEF
OM0-CCA	805 039	Screw adapter 3/4"-14 NPTF
OM0-CCB	805 040	Screw adapter 1-1/8"-12 UNF
OM0-CCC	805 041	Flange adapter 3-hole
OM0-CCD	805 042	Rotalock adapter 1-3/4"-12UNF
OM0-CCE	805 043	Rotalock adapter 1-1/4"-12UNF
OM0-CUD	805 049	Flange adapter 6- / 6-hole

Compressor models see OM3 series.

3. Relay Cables

OM3-N30	805 141	Connection to Relay	3.0m
OM3-N60	805 142		6.0m
OM3-N100	805 146		10.0m

4. Power Cable

Type	Part No.	Description	Cable length
OW-24V-3	804 672	Connection to Power Supply 24VAC	3.0m

Level Watch LW4 and LW5

The LW4 and LW5 are self-contained units with embedded electronics and sight glass to monitor oil and refrigerant liquid levels in vessels.

Features

- Max. working pressure: 130 bar (LW5) , 60 bar LW4
- Reliable and proven hall sensor technology with full visual liquid level control versus optical systems without visual inspection possibility
- Two individual output signals for level control and alarm at different liquid levels
- Easy installation by sight glass replacement and front side mounting without nuts
- Visual inspection of liquid or oil level still possible
- 3-zone level control by using precise hall sensor
- Alarm, status and level indication by LEDs
- Supply 24V AC



LW5

Selection (select one item of each group)

1. Base Unit (supplied without adapter)

Type	Part No.	Max. working pressure	Time delay alarm
LW4-H120	805 491	60 bar	20 sec
LW4-L120	805 490	60 bar	20 sec
LW5-H120	805 481	130 bar	120 sec
LW5-L120	805 480	130 bar	120 sec

2. Adapter flange LW4/LW5

LW0-CCA	805 254	Steel Adapter 3/4"-14 NPTF
OM0-CUA	805 037	Flange adapter 3- / 4-hole
OM0-CBB	805 038	Screw adapter 1-1/8"-18 UNEF
OM0-CCA	805 039	Screw adapter 3/4"-14 NPTF
OM0-CCB	805 040	Screw adapter 1-1/8"-12 UNF
OM0-CCC	805 041	Flange adapter 3-hole
OM0-CCD	805 042	Rotalock adapter 1-3/4"-12UNF
OM0-CCE	805 043	Rotalock adapter 1-1/4"-12UNF

3. Relay Cables

OM3-N30	805 141	Connection to Relay	3.0m
OM3-N60	805 142		6.0m
OM3-N100	805 146		10.0m

4. Power Cable (for additional signal output 3 wire relay cable has to be used)

Type	Part No.	Description	Cable length
LW-24V-3	805 500	Connection to Power Supply 24V AC	3.0m
LW-24V-6	805 501	Connection to Power Supply 24V AC	6.0m
LW-24V-10	805 502	Connection to Power Supply 24V AC	10.0m

Technical Data

CE marked under: Low Voltage Directive EMC Directive	2006/95/EC 89/336/EC
Applied Standards:	EN 12284, EN 378, EN 61010, EN 50081-1, EN 50082-1
Max. working pressure PS: Max. test pressure PT: Burst Pressure:	LW4: 60 bar LW5: 130 bar LW4: 66 bar LW5: 143 bar LW4: 230 bar LW5: 390 bar
Supply voltage current	24VAC, 50/60Hz, +10/-15%, 0.05A
Vibration resistance (EN60068-2-6)	max. 4g, 10....250Hz
Medium temperature Ambient/Storage temperature	-20 to 80°C -20 to 50°C
Medium compatibility	HCFC, HFC, CO ₂ , mineral, syn- thetic and ester lubricants

Materials: Body and Adaptor Screws LW4 Screws LW5 Sight Glass LW4 Sight Glass LW5	aluminum (EN AW 6060) stainless steel (ISO 4762) galvanized steel nickel-plated steel (1.05.03 DIN EN 10027) galvanized steel (ISO 2081)
Orientation of base unit: Level control:	horizontal, +/- 1° 40% to 60% sight glass height
Alarm contact:	max. 3A, 230VAC SPDT dry contact
Time Delay Alarm:	120 sec
Protection class	IP 65 (IEC529/EN 60529)
Weight	850 ... 920g incl. adapter

Oil Separator Series OS

Features

- Three different construction styles:
 - Hermetic
 - Top flange
 - Bottom flange with support bracket
- Stainless steel needle valve and floater
- Permanent magnet to catch iron particles out of the system
- Corrosion-resistant epoxy powder coating
- ODF Copper fittings for easy soldering
- Temperature range TS: -10°C ... +150°C
- Max. allowable pressure PS: 31 bar
- CE marking according PED 97/23 EC



OSH



OST



OSB

Type Code

Product line Oil Separators

Construction

- H: Hermetic
- T: Top flange
- B: Bottom flange with supporter

Nominal shell diameter

- 4: approx. 10 cm
- 6: approx. 15 cm

OS X -X XX

ODF connection

- 04: 1/2"
- 05: 5/8" (16mm)
- 07: 7/8" (22mm)
- 09: 1 1/8"
- 11: 1 3/8" (35mm)
- 13: 1 5/8"
- 17: 2 1/8"

Type	Part No.	Connection	Conformity Assessment Category	Conformity Assessment Procedure	Nominal capacity (kW)			Volume Lit.
					R22/R407C	R134A	R404A/ R507	
OSH-404	881 598	1/2"	Cat. I	Module A*	7.0	4.9	7.3	2.0
OSH-405	881 599	5/8"			18.7	13.1	19.4	2.4
OSH-407	881 600	7/8"			28.1	19.7	29.0	2.8
OSH-409	881 792	1 1/8"			37.4	26.2	38.7	3.0
OSH-411	881 794	1 3/8"			46.8	32.8	48.4	3.6
OSH-413	881 856	1 5/8"			65.5	45.9	67.8	3.6
OSH-611	881 940	1 3/8"	Cat. II	Module D1	51.5	36.1	53.3	6.5
OSH-613	881 953	1 5/8"			65.5	45.9	67.8	7.9
OSH-642	889 022	42 mm			65.5	45.9	67.8	7.9
OSH-617	881 970	2 1/8"			105.3	73.8	108.9	7.9
OST-404	881 860	1/2"	Cat. I	Module A*	7.0	4.9	7.3	1.8
OST-405	881 861	5/8"			18.7	13.1	19.4	2.6
OST-407	881 862	7/8"			28.1	19.7	29.0	3.2
OST-409	881 863	1 1/8"			37.4	26.2	38.7	3.8
OST-411	881 938	1 3/8"			46.8	32.8	48.4	3.8
OST-413	881 939	1 5/8"			65.5	45.9	67.8	3.8
OSB-613	881 971	1 5/8"	Cat. II	Module D1	65.5	45.9	67.8	7.8
OSB-617	881 972	2 1/8"			105.3	73.8	108.9	7.8

* applied higher module as required

Capacity Data For Other Than Nominal Operating Conditions

Nominal capacities at +38°C condensing temperature (+38°C bubble point or +43°C dew point for R407C), +4°C evaporating temperature (saturated temperatures / dew point) and 1 K liquid subcooling at the inlet of the expansion valve.

Correction factor for other evaporating temperatures than nominal:

$$Q_n = Q_o \times K_t$$

Q_n : Nominal capacity

K_t : Correction factor for a pressure drop corresponding 1 K saturation temperature

Q_o : Required cooling capacity

Correction Factors

Refrigerant	Condensing Temperature °C	Correction factor Kt Evaporating Temperature °C						
		+10	0	-10	-20	-30	-40	-50
R22 R407	+25	1.29	1.31	1.33	1.36	1.40	1.44	1.49
	+30	1.16	1.17	1.20	1.23	1.27	1.31	1.36
	+35	1.05	1.07	1.09	1.11	1.13	1.17	1.23
	+40	0.95	0.96	0.98	1.00	1.03	1.07	1.12
	+45	0.87	0.88	0.90	0.92	0.95	0.99	1.04
	+50	0.81	0.83	0.85	0.87	0.89	0.93	0.99
R134a	+25	1.31	1.36	1.39	1.43	1.50		
	+30	1.18	1.21	1.24	1.28	1.35		
	+35	1.06	1.08	1.11	1.15	1.21		
	+40	0.95	0.98	1.01	1.05	1.10		
	+45	0.86	0.88	0.92	0.95	1.02		
	+50	0.80	0.81	0.85	0.89	0.97		
R404A R507	+25	1.22	1.25	1.30	1.33	1.43	1.53	1.63
	+30	1.12	1.15	1.20	1.26	1.32	1.42	1.54
	+35	1.03	1.06	1.11	1.16	1.24	1.34	1.46
	+40	0.95	0.99	1.04	1.09	1.17	1.28	1.41
	+45	0.90	0.92	0.97	1.03	1.14	1.26	1.39
	+50	0.86	0.89	0.93	1.00	1.13	1.26	1.39

Suction Accumulators, Ball Valves and Oil Test Kit

Suction Accumulators

Features

- Hermetic design
- ODF Copper fittings for easy soldering
- Corrosion-resistant epoxy powder coating
- Internal orifice with strainer for optimum oil return
- Temperature range TS: -45°C to +65°C
- Max. allowable pressure PS:
20.7 bar (-10°C to +65°C)
15.5 bar (-45°C to -10°C)
- CE marking for certain types according PED 97/23 EC
- HP marking for certain types according German pressurised vessels directive
- UL/CUL file number: SA 10225



A08

Type	Part No.	Conne- ction *(inch)	Nominal Capacity Qn (KW)						Conformity Assessment		Volume Lit.	
			R22/R407		R134a		R404A/R507		Category	procedure		
			Max.	Min.	Max.	Min.	Max.	Min.				
A08-304	001 973	½	7.0	1.1	4.2	0.6	4.6	0.7	HP Marking (CE Marking not required)	0.73		
A10-305	001 977	⅝	10.5	1.6	6.0	0.9	7.0	1.1		0.93		
A12-305	001 978	⅝	10.5	1.6	6.0	0.9	7.0	1.1		1.16		
A12-306	001 979	¾	14.0	2.1	8.1	1.2	9.1	1.4		1.16		
A14-305	001 980	⅝	10.5	1.6	6.0	0.9	7.0	1.1		1.40		
A14-306	001 987	¾	14.0	2.1	8.1	1.2	9.1	1.4		1.40		
A06-405	001 989	⅝	10.5	1.6	6.0	0.9	7.0	1.1		0.93		
A10-405	001 990	⅝	10.5	1.6	6.0	0.9	7.0	1.1		1.75		
A10-406	001 994	¾	14.0	2.1	8.1	1.2	9.1	1.4		1.75		
A09-506	881 995	¾	14.0	2.1	8.1	1.2	9.1	1.4		Cat. I Mod. D1*	2.33	
A09-507	882 455	⅞	25.6	3.8	14.0	2.1	16.1	2.4	2.73			
A12-506	881 996	¾	14.0	2.1	8.1	1.2	9.1	1.4	3.29			
A12-507	881 998	⅞	25.6	3.8	14.0	2.1	16.1	2.4	3.29			
A13-507	882 007	⅞	25.6	3.8	14.0	2.1	16.1	2.4	3.80			
A13-509	882 011	1 ⅛	41.4	6.2	25.3	3.8	26.7	4.0	3.80			
A17-509	882 012	1 ⅛	41.4	6.2	25.3	3.8	26.7	4.0	4.87			
A17-511	882 013	1 ⅜	66.0	9.9	37.6	5.6	42.8	6.4	4.87			
A11-607	882 014	⅞	25.6	3.8	14.0	2.1	16.1	2.4	4.30			
A13-607	882 015	⅞	25.6	3.8	14.0	2.1	16.1	2.4	4.98			
A13-609	882 019	1 ⅛	41.4	6.2	25.3	3.8	26.7	4.0	4.98			
A14-611	882 020	1 ⅜	66.0	9.9	37.6	5.6	42.8	6.4	5.48			
A17-613	882 022	1 ⅝	100.0	15.0	59.7	9.0	63.9	9.6	6.85			
A17-642	889 023	42 mm	100.0	15.0	59.7	9.0	63.9	9.6	6.85			
A20-613	882 021	1 ⅝	100.0	15.0	59.7	9.0	63.9	9.6	8.21			
A25-613	882 023	1 ⅝	100.0	15.0	59.7	9.0	63.9	9.6	Cat II		Mod. D1*	10.23

* applied higher module as required

Correction factor for other evaporating temperatures than nominal:

$$Q_n = Q_o \times K_t$$

Q_n : Nominal capacity
 K_t : Correction factor for a pressure drop
 corresponding 1 K saturation temperature
 Q_o : Required cooling capacity

Evaporating Temperature (°C)	+4	0	-5	-10	-15	-20	-25	-30	-35	-40
Correction Factor K_t	1.00	1.12	1.35	1.75	2.00	2.50	3.00	3.75	5.00	6.60

Ball Valves Series BVE/BVS and CVE/CVS

Features

- BVE/S for HFC & CO₂, Max. allowable pressure 45 bar
- CVE/S for HFC & CO₂, Max. allowable pressure 60 bar
- BVS/CVS version with Schrader valve
- Two threads at valve body for easy mounting
- Hermetic design
- Compatible with high-pressure refrigerants as R410A and CO₂ (sub-critical)
- Lightweight design – LASER welded brass body
- Virgin PTFE seat gaskets
- Bi-directional flow characteristics
- Valve cap retained by strap attached to main body
- Pressure relief port design
- UL approval (only for BVE/BVS models) and CE marking acc. PED 97/23 EC



- Applied Standards EN 12284, EN 378, EN12420, PED 97/23/EC,
- RoHS 2002/95/EC
- To protect valve from unauthorized use a special seal cap is available as accessory (see below)

BVE/BVS selection table (UL approved)

Type BVE	Part No.	Type BVS	Part No.	Connection size ODF	
				inch	metric
BVE-014	806 730	BVS-014	806 750	¼"	
BVE-M06	806 731	BVS-M06	806 751		6mm
BVE-038	806 732	BVS-038	806 752	⅜"	
BVE-M10	806 733	BVS-M10	806 753		10mm
BVE-012	806 734	BVS-012	806 754	½"	
BVE-M12	806 735	BVS-M12	806 755		12mm
BVE-058	806 736	BVS-058	806 756	⅝"	16mm
BVE-034	806 737	BVS-034	806 757	¾"	
BVE-078	806 738	BVS-078	806 758	⅞"	22mm
BVE-118	806 739	BVS-118	806 759	1 ⅛"	
BVE-M28	806 740	BVS-M28	806 760		28mm
BVE-138	806 741	BVS-138	806 761	1 ⅜"	35mm
BVE-158	806 742	BVS-158	806 762	1 ⅝"	
BVE-M42	806 743	BVS-M42	806 763		42mm
BVE-218	806 744	BVS-218	806 764	2 ⅛"	54mm
BVE-258	806 745	BVS-258	806 765	2 ⅝"	
BVE-318	806746	BVS-318	806766	3 ⅛"	

Technical Data

Max. allowable pressure PS	BVE/BVS 45 bar; CVE/CVS 60 bar
Test pressure PT	BVE/BVS 49.5 bar; CVE/CVS 66 bar
Medium temperature TS	-40 ... 120°C (150°C short term)
Medium compatibility	HFC, HCFC, CO ₂ , Mineral, Synthetic and Polyol-Ester (POE) lubricants

Special Seal Caps to protect valve from unauthorized use

BVE / BVS , CVE / CVS Valve Size	Part No.	Thread (3)	Quantity per pack
¼" ... ⅞" (6 ... 22mm)	806 770M	M18x1	10 pcs
1-⅞" ... 1 ⅜" (28 ... 35mm)	806 771M	M27x1	10 pcs
1-⅝" (42 mm) ... 3-⅞"	806 772M	M36x1	10 pcs

CVE/CVS selection table (Not UL approved)

Type CVE	Part No.	Type CVS	Part No.	Connection size ODF	
				inch	metric
CVE-014	808 130	CVS-014	808 150	¼"	
CVE-M06	808 131	CVS-M06	808 151		6mm
CVE-038	808 132	CVS-038	808 152	⅜"	
CVE-M10	808 133	CVS-M10	808 153		10mm
CVE-012	808 134	CVS-012	808 154	½"	
CVE-M12	808 135	CVS-M12	808 155		12mm
CVE-058	808 136	CVS-058	808 156	⅝"	16mm
CVE-034	808 137	CVS-034	808 157	¾"	
CVE-078	808 138	CVS-078	808 158	⅞"	22mm

Acid Test Kit Series AOK

Features

- Quick & easy test kit
- Universal acid test kit for use with all oils:
- Mineral, POE, etc.
- By changing the percentage of oil sample taken, the acid number of the oil can be accurately determined
- Phase separation of the chemicals in the kit provide a positive colour change regardless of the colour and condition of the oil

Type	Part No.
AOK-U01	804 166



AOK

Controller Kits Parts List

Controller Kit	PCN	Terminal Kits								Sensors			Transformers		Pressure Transmitters			Cable Assembly PT5			
		807 644	807 645	804 559	800 050	807 647	800 070	807 656	807 648	807 653	807 654	804 283	804 497	804 284	804 424	804 421	802 350	802 351	802 352	804 805	PT4-M60
Superheat																					
EC3-D72 Ctr. Kit TCP/IP	808 042																				
EC3-D73 Ctr. Kit	808 049																				
EC3-D73 Ctr. Kit	808 041																				
EC3-X32 Ctr. Kit TCP/IP	808 037	1																			
EC3-X33 Ctr. Kit	808 036		1																		
EXD-U00 Ctr. Kit	808 038			1																	
Display Case																					
EC2-312 Ctr. Kit TCP/IP	808 005				1																
EC2-352 Ctr. Kit TCP/IP	808 009				1																
EC2-372 Ctr. Kit TCP/IP	808 011				1																
EC2-392 Ctr. Kit TCP/IP	808 007				1																
Cond. Unit & Condenser																					
EC2-552 Ctr. Kit TCP/IP	808 019					1															
Cold Room																					
EC3-331 Ctr. Kit LON	808 012																				
EC3-332 Ctr. Kit TCP/IP	808 013																				

Accessories, Spare Parts & Appendix

Electronic controllers

Description	Type	Part No.
EC3 Replacement battery		807 790

Thermo™ - Expansion Valves

Bulb clamp for XB1019	XA 1728-4	803 260
Bulb clamp for XC726	XA 1728-5	803 261
Service Tool for T Series	X 99999	800 005
Gasket sets for T, ZZ, L, 935 and TG Series valves	X 13455-1	027 579
Bronze Screws for following flange types: (mandatory for ZZ-Valves) C500, C501, 9761, X6346, X6669, A576 9148, 9149, 9152, 9153, 10331, 10332	Screw BZ 32	803 575
	Screw BZ 48	803 576
Steel Screws for following flange types: C500, C501, 9761, X6346, X6669, A576 9148, 9149, 9152, 9153, 10331, 10332	Screw ST 32	803 573
	Screw ST 48	803 574

Solenoid Valves

Retainer kit		801 080	
Service tool for 110RB, 240RA, 540RA, M36	X 11981-1	027 451	
Plug acc. To EN 175301 cable gland PG9	GDM 2009 / PG9	801 012	
Plug acc. To EN 175301 cable gland PG11	GDM 211 / PG11	801 013	
Repair kits:	110 RB	KS 30040-1	801 206
	200 RB	KS 30039/	
		KS 30109	801 205
	240RAB	KS 30061	801 262
	240RA9	KS 30062	802 263
	240RA12	KS 30063	803 264
	240RA16	KS 30065	801 200
	240RA20	KS 30097	801 216
	M36-078 / M36-118 / 3031 (upper assembly inc. Gasket)	M36-UNF	801 440
Gasket kits:	110 RB	KS 30040-2	801 232
	200 RB	KS 30039-1	802 233
	240RAB	KS 30061-1	803 234
	240RA9/12	KS 30062-1	804 235
	240RA16	KS 30065-1	805 236
	240RA20	KS 30097-1	806 237
	all 3031	KS 30177-1	807 268

Pressure Controls

Mounting bracket, angle, including screws Universal for PS1, PS2, FD113		803 799
Mounting bracket universal		803 798
Extension bracket for PS1, PS2		803 800
Mounting plate for units with hood		803 801
Plug acc. EN 175301 for PS3	Cable gland PG9	801 012
	Cable gland PG11	801 013
Capillary tube with flare nuts 7/16" - 20UNF, 1/4" SAE, 1.5 m		803 804
Copper gasket set (100 pcs) for R1/4" (7/16" - 20UNF, female)		803 780
Locking plate for PS1, PS2, TS1		803 783

Description	Type	Part No.
-------------	------	----------

Thermostats

Mounting bracket angle		803 799
Universal mounting bracket		803 798
Extension bracket for TS1		803 800
Insulation console TS1 standard		0146 391
Capillary tube glands R 1/2" thread, for bulb style A/C		803 807
Capillary tube holder (5 pcs)		803 778
Capillary tube with fl are nuts 3/16" - 20UNF, 1/4" SAE, 1.5m		803 804

Oil Management

OM3 / OM4	Transformer 230 VAC / 24VAC, 25VA	ECT-323	804 424
	Transformer 230 VAC / 24VAC, 60VA	ECT-623	804 421
	Differential oil check valve 3.5 bar, PS: 35 bar (inlet 3/8" - UNF female, outlet 3/8" - UNF male)	ODP-33A	800 366
	Repair kit for all OM3/OM4 types (all necessary gaskets, coil clip, oil adapter with strainer, sight glass)	OM3-K01	805 036
OM5	Repair Kit (consists of all necessary o-rings, oil adapter with strainer, sight glass, screws)	OM5-K01	805 067
OS	Gasket set for OSB / OST (50 pcs)	X 99956	007 591

Filter Driers

All ADKS, ADKS-Plus			
	Gasket set	X 99961	003 710
	Schrader nipple 1/4" NPT	X 11562-2	803 251
	Core holder	X 99963	003 712
FDS 48			
	O'Ring set	X 99962	003 711
FDS 24			
	Gasket set	X 99967	003 716
	O'Ring set	X 99968	003 717
	Core holder	X 99969	003 718
BTAS			
Repair kits with screws, gaskets, spring and brass cover:			
	BTAS 2	KD 30519-2	065 970
	BTAS 3	KD 30519-3	065 971
	BTAS 4	KD 30519-4	065 972
	BTAS 5	KD 30519-5	065 973

Indicators

AMI upper part with indicator	X 12978-1	805 742
O'Rings 20 pcs	X 99995	805 643

Ball Valves

BVE/BVS special cap to protect valve from un-authorized use (10 pcs)		
	1/4" - 3/8" (6-22mm)	806 770
	1 1/8" - 1 3/8" (28-35mm)	806 771
	1 3/8" - 3 1/8" (42-54mm)	806 772

Conversion Table

Power

kW / h = Kcal / h : 860	Kcal / h = kW / h x 860
kW = US ton of refrigeration : 0,284	US ton of refrigeration = kW x 0,284
kW = BTU / h : 3413	BTU / h = kW x 3413

Temperature

°C = (°F - 32) : 1,8	°F = (°C x 1,8) + 32
----------------------	----------------------

Pressure

bar = PSI : 14,5 1 bar = 100 000 Pascal	PSI = bar x 14.5 100 Pascal = 1 mbar
--	---

Connections

Specification		Connection Tube			Thread
		SAE	inch	metric	
SAE	Flare	SAE ¼"	¼"	6mm	7/16" - 20UNF
		SAE 5/16"	5/16"	8mm	9/16" - 18UNF
		SAE 3/8"	3/8"	10mm	5/8" - 18UNF
		SAE ½"	½"	12mm	¾" - 16UNF
		SAE 5/8"	5/8"	16mm	7/8" - 14UNF
		SAE ¾"	¾"	18mm	1 1/16" - 14UNF
		SAE 7/8"	7/8"	22mm	1 ¼" - 12UNF
		SAE 1"	1"	25mm	1 ½" - 12UNF
			1 1/8"		
			1 3/8"	35mm	
			1 5/8"		
			2 1/8"	54mm	
			2 3/8"		
	3 1/8"				
R or G same as BSP	Pipe thread female cylindrical	Male thread: R / NPT / BSP / G			Withworth- Pipe thread DIN 2999 / ISO 228
R same as BSP	Pipe thread male tapering	Female thread: R / NPT / BSP / G			Withworth- Pipe thread DIN 2999
G	Pipe thread male cylindar	Female thread: R / BSP / G			Withworth- Pipe thread ISO 228
NPT	Pipe thread female tapering	Male thread: R / NPT / BSP			Standard taper Pipe thread ASA B 2.1
	Pipe thread male tapering	Female thread: R / NPT / BSP / G			
ODF Outside Diameter Female	Solder female	Given dimension is outside tube diameter. Tube has to be pushed into ODF connection.			
ODM Outside Diameter Male	Solder male	Given dimension is outside tube diameter. Expanded tube can be pushed onto ODM connection or tube can be connected through a sleeve with the ODM connection.			

Saturation Pressure Table for Refrigerants (bar, absolute)

Temperature °C	R410A	R134a	R22	R404A		R507	R407C	
	ALCO-Symbol							
	Z	M	H	S		S	N	
				Liquid	Vapor		Liquid	Vapor
+85		29.29	40.29					
+80		26.35	36.52					
+75		23.65	33.40					
+70		21.17	29.83	33.34	33.01			
+65		18.89	26.87	31.95	31.84	32.91		
+60	38.44	16.81	24.15	28.75	28.63	29.59		
+55	34.47	14.91	21.64	25.80	25.66	26.54	24.91	22.48
+50	30.79	13.17	19.33	23.08	22.94	23.73	22.24	19.80
+45	27.41	11.59	17.21	20.58	20.44	21.14	19.79	17.52
+40	24.31	10.16	15.27	18.29	18.15	18.78	17.55	15.39
+35	21.47	8.87	13.50	16.20	16.06	16.62	15.50	13.46
+30	18.90	7.70	11.88	14.29	14.15	14.65	13.63	11.73
+25	16.56	6.65	10.41	12.55	12.42	12.86	11.93	10.17
+20	14.45	5.72	9.08	10.98	10.85	11.24	10.41	8.78
+15	12.55	4.88	7.88	9.56	9.44	9.78	9.03	7.54
+10	10.85	4.15	6.80	8.28	8.17	8.47	7.79	6.44
+8	10.22	3.88	6.40	7.80	7.70	7.98	7.33	6.03
+6	9.62	3.62	6.02	7.35	7.25	7.52	6.90	5.65
+4	9.04	3.38	5.66	6.92	6.82	7.08	6.48	5.28
+2	8.49	3.15	5.31	6.51	6.41	6.65	6.09	4.94
0	7.97	2.93	4.98	6.11	6.01	6.25	5.71	4.61
-2	7.48	2.72	4.66	5.74	5.64	5.86	5.34	4.30
-4	7.00	2.53	4.36	5.38	5.29	5.50	5.00	4.00
-6	6.55	2.34	4.08	5.04	4.95	5.15	4.68	3.72
-8	6.12	2.17	3.81	4.71	4.63	4.82	4.37	3.46
-10	5.72	2.01	3.55	4.40	4.32	4.50	4.08	3.21
-12	5.33	1.86	3.31	4.11	4.03	4.20	3.80	2.97
-14	4.97	1.71	3.08	3.83	3.76	3.92	3.53	2.75
-16	4.62	1.58	2.86	3.57	3.50	3.65	3.29	2.54
-18	4.29	1.45	2.65	3.32	3.25	3.40	3.05	2.34
-20	3.98	1.33	2.46	3.09	3.02	3.15	2.83	2.16
-22	3.69	1.22	2.27	2.86	2.80	2.93	2.62	1.99
-24	3.42	1.12	2.10	2.65	2.59	2.71	2.42	1.82
-26	3.16	1.02	1.94	2.46	2.40	2.51	2.23	1.67
-28	2.91	0.93	1.78	2.27	2.21	2.32	2.06	1.53
-30	2.68	0.85	1.64	2.10	2.04	2.14	1.89	1.40
-32	2.47	0.77	1.51	1.93	1.88	1.98	1.74	1.28
-34	2.27	0.70	1.38	1.78	1.73	1.82	1.60	1.16
-36	2.08	0.63	1.26	1.63	1.58	1.67	1.46	1.05
-38	1.90	0.57	1.16	1.49	1.45	1.53	1.34	0.96
-40	1.74	0.52	1.05	1.37	1.33	1.40	1.22	0.87
-42	1.58	0.47	0.96	1.25	1.21	1.28	1.11	0.78
-44	1.44	0.42	0.87	1.14	1.10	1.17	1.01	0.70
-46	1.31	0.37	0.79	1.04	1.00	1.07	0.92	0.63
-48	1.18	0.34	0.72	0.94	0.91	0.97	0.83	0.57
-50	1.07	0.30	0.65	0.85	0.82	0.88	0.75	0.51
-52	0.96	0.27	0.58	0.77	0.74	0.80	0.68	0.45
-54	0.87	0.24	0.52	0.70	0.67	0.72	0.61	0.40
-56	0.78	0.21	0.47	0.63	0.60	0.62	0.55	0.36
-58	0.70	0.19	0.42	0.56	0.54	0.59	0.49	0.32
-60	0.62	0.16	0.38	0.51	0.48	0.53	0.44	0.28

Temperature °C	R23
	ALCO-Symbol
	B
25	47.24
20	41.84
15	36.97
10	32.58
5	28.62
0	25.04
-5	21.83
-10	18.94
-15	16.35
-20	14.03
-25	11.97
-30	10.14
-35	8.53
-40	7.12
-45	5.89
-50	4.83
-52	4.45
-54	4.09
-56	3.75
-58	3.44
-60	3.14
-62	2.87
-64	2.61
-66	2.37
-68	2.15
-70	1.95
-72	1.76
-74	1.58
-76	1.42
-78	1.28
-80	1.14
-82	1.02
-84	0.90
-86	0.80
-88	0.71
-90	0.62
-92	0.55
-94	0.48
-96	0.42
-98	0.36
-100	0.32
-102	0.27
-104	0.23
-106	0.20
-108	0.17
-110	0.14
-112	0.12
-114	0.10
-116	0.09
-118	0.07
-120	0.06

For component selection in R404A and R407C applications, use the values in the columns highlighted in green.

CE per Pressure Vessel Directive CE97/23/EC

Filter Driers

Product	Fluid group	Volume (liter)	TS (°C)	PS (bar)	Hazard category	Conformity assessment module	Marking
ADK-03 / 05 / 08 / 16...	II	0.1 ... 0.38	-40 ... +65	45	SEP	-	HP & UL
ADK-30 / 41 / 75...	II	0.4 ... 0.65		45	SEP	-	HP & UL
FDB-03 / 05 / 08 / 16...	II	0.1 ... 0.38		45	SEP	-	HP & UL
FDB-30 / 41...	II	0.45 ... 0.5		45	SEP	-	HP & UL
BFK-05 / 08 / 16...	II	0.18 ... 0.32		45	SEP	-	HP & UL
BFK-30...	II	0.4		45	SEP	-	HP & UL
FDS-24...	II	1.0	-10 ... +65 (-45 ... -10)	34.5 (25.9)	SEP	-	HP & UL
ADKS-48...	II	2.1			I	A	CE & UL
ADKS-96...	II	3.8			I	A	CE & UL
ADKS-144...	II	5.4			I	A	CE & UL
ADKS-192...	II	7.0			I	D1	CE0036 & UL
ASD/ASF-28.../35.../45...	II	<1.0	-45 ... +50	27.5	SEP	-	HP & UL
ASD/ASF50.../75...	II	<1.4			SEP	-	HP & UL
BTAS-2...	II	0.42	-45 ... +50	24	SEP	-	HP & UL
BTAS-3...	II	1.1			SEP	-	HP & UL
BTAS-4...	II	1.97			SEP	-	HP & UL
BTAS-5...	II	3.19			I	A	CE & UL

Oil Management / Components

OSH-404	II	2.0	-10 ... +150	31	I	A	HP & UL		
OSH-405	II	2.4			I	A	HP & UL		
OSH-407	II	2.8			I	A	HP & UL		
OSH-409	II	3.0			I	A	HP & UL		
OSH-411 / -413	II	3.6			I	A	HP & UL		
OST-404	II	1.8			I	A	HP & UL		
OST-405	II	2.6			I	A	HP & UL		
OSH-407	II	3.2			I	A	CE & UL		
OST-409 / -411 / -413	II	3.8			I	A	CE & UL		
OSH-611	II	6.5			II	D1	CE & UL		
OSH-613 / -617	II	7.9			II	D1	CE0036 & UL		
OSB-613 / -617	II	7.8			II	D1	HP & UL		
OM3	II	DN 6MM			-20 ... +80	35	SEP	CE under Low Voltage and EMC Directive	
OM4 & OW4	II	DN 6MM			-20 ... +80	60	SEP	CE under Low Voltage and EMC Directive	

Suction Accumulators

A08-304	II	0.9	-10 ... +65 (-45 ... 10)	20.7 (15.5)	SEP	-	HP & UL
A10-305	II	1.1			SEP	-	HP & UL
A12-305 / -306	II	1.3			SEP	-	HP & UL
A14-305 / -306	II	1.6			SEP	-	HP & UL
A06-404 / -405	II	1.2			SEP	-	HP & UL
A10-405 / -406	II	2.1			SEP	-	HP & UL

Suction Accumulators (continued)

Product	Fluid group	Volume (liter)	TS (°C)	PS (bar)	Hazard category	Conformity assessment module	Marking
A09-506 / -507	II	2.7	-10 ... +65 (-45 ... -10)	20.7 (15.5)	I	A	CE & UL
A12-506 / -507	II	3.8			I	A	CE & UL
A13-507 / -509	II	4.3			I	A	CE & UL
A17-509 / -511	II	5.4			I	A	CE & UL
A11-607	II	5.1			I	A	CE & UL
A13-607 / -609	II	5.8			I	A	CE & UL
A14-611	II	6.4			I	A	CE & UL
A17-613	II	7.9			I	A	CE & UL
A20-613	II	9.4			I	A	CE & UL
A25-613	II	11.6			II	D1	CE0036 & UL

Pressure Switches

Product	Fluid group	DN (mm)	TS (°C)	PS (bar)	Hazard category	Conformity assessment module	Marking	
PS1-B3..., PSA-B3...		6	-50 ... +70	22	IV	B, D	CE0035 & UL	
PS1-S3..., PSA-S3...		6			IV	B, D	CE0035 & UL	
PS1-W3..., PSA-W3...		6			IV	B, D	CE0035 & UL	
PS1-B5..., PSA-B5...		6		32	IV	B, D	CE0035 & UL	
PS1-S5..., PSA-S5...		6			IV	B, D	CE0035 & UL	
PS1-W5..., PSA-W5...		6			IV	B, D	CE0035 & UL	
All other PS1 types		6		22/32	Under LVD, excluded from PED		CE & UL	
PS2-B7..., PSB-B7...		6	50 ... +70	22	IV	B, D	CE0035 & UL	
PS2-C7..., PSB-C7...		6			IV	B, D	CE0035 & UL	
PS2-T7..., PSB-T7...		6			IV	B, D	CE0035 & UL	
PS2-B7..., PSB-B7...		6		32	IV	B, D	CE0035 & UL	
PS2-C7..., PSB-C7...		6			IV	B, D	CE0035 & UL	
PS2-C8..., PSB-C8...		6			IV	B, D	CE0035 & UL	
PS2-G8..., PSB-G8...		6			IV	B, D	CE0035 & UL	
PS2-S8..., PSB-S8...		6			IV	B, D	CE0035 & UL	
PS2-T7..., PSB-T7...		6			IV	B, D	CE0035 & UL	
PS2-W7..., PSB-W7...		6		IV	B, D	CE0035 & UL		
All other PS2 types		6		22/32	Under LVD, excluded from PED		CE	
PS3-B.1...,PS3-W.1...		6		-40 ... +70	27	IV	B, D	CE0035 & UL
PS3-B.4...,PS3-S.4...		6		-40 ... +70	32	IV	B, D	CE0035 & UL
PS3-B.5...,PS3-S.5...		6				IV	B, D	CE0035 & UL
PS3-W.4...,PS3-W.5...	6	IV	B, D			CE0035 & UL		
PS3-C.4...,PS3-T.4...,PS3-X.4...	6	-40 ... +150	32	IV	B, D	CE0035 & UL		
PS3-C.5...,PS3-T.5...,PS3-X.5...	6			IV	B, D	CE0035 & UL		
PS3-B6...,PSC-B6...	6	-40 ... +150	43	IV	B, D	CE0035 & UL		
PS3-W6...,PSC-W6...	6			IV	B, D	CE0035 & UL		
PS3-S6...,PSC-S6...	6			IV	B, D	CE0035 & UL		
All other PS3 type	6	-40 ... +70	27/32	Under LVD, excluded from PED		CE		
PS4-W..., PS4-BL...	6	-30 ... +80	25/41/55/69	IV	B, D	CE		
FD113...	6	Under LVD, excluded from PED				CE & UL		

LVD = Low Voltage Directive

Fan Speed Controllers

Product	Fluid group	DN (mm)	TS (°C)	PS (bar)	Hazard category	Conformity assessment module	Marking
FSY-41...	II	6	-20 ... +70	27	under LVD, excluded from PED		CE
FSY-42...	II	6		32			CE
FSY-43...	II	6		43			CE

Transmitters

PT5-07M/T	II	6	-40 ... +80 mobile applic.: -25 ... +80	27	SEP	-	CE
PT5-18M/T	II	6		55	SEP	-	CE
PT5-30M/T	II	6		60	SEP	-	CE
PT5-50M/T	II	6		100	SEP	-	CE
PT5-150D	II	6	-40 ... +80	150	SEP	-	CE

Thermo™ Expansion Valves and Electrical Control Valves

TI	II	max. 16	-45 ... +65	45	SEP	-	-
TX3	II	max. 16		45	SEP	-	-
TX6-H/M/N/S..	II	max. 22		31	SEP	-	-
TX6-Z..	II	max. 22		42	SEP	-	-
T-series with XB / XC power element	II	max. 28		46 / 31	SEP	-	-
L-series with XB / XC power element	II	max. 28		46 / 31	SEP	-	-
935-series with XB / XC power element	II	max. 28		46 / 31	SEP	-	-
ZZ-series	II	max. 28	-120 ... +65	31	SEP	-	-
EX2	II	max. 12	-40 ... +50	40	SEP	-	-
EX4/EX5/EX6	II	max. 22	-50 ... +100	45	SEP	-	-
EX7	II	35		45	I	A	CE
EX8	II	42		45	I	A	CE

Solenoid Valves

110 RB 2...	II	6...10	-40 ... +120	31	SEP	-	-
200 RB 3/4/6...	II	10 ... 16		31	SEP	-	-
200 RH 3-6T4/6T5	II	10 ... 16		60/50	SEP	-	-
240 RA 8/9/12...	II	16 ... 28		31	SEP	-	-
240 RA 16T9	II	28		31	SEP	-	-
240 RA 16T11	II	35		31	I	A	CE
240 RA 20T11/13/17...	II	35 ... 54		31	I	A	CE
540 RA 8/9/12/16...	II	16 ... 28		31	SEP	-	-
540 RA 20T11	II	35 ... 54		28	SEP	-	-
M36-078	II	28		-40 ... +120	35	SEP	-
M36-118	II	28	35		SEP	-	-

Regulators

ACP	II	6...10	-40 ... +120	31	SEP	-	-
CPHE...	II	12 ... 28		28	SEP	-	-
PRE/PRC	II	16 ... 35	-30... +80	25	SEP	-	-

Ball valves

BVE/BVS...	II	≤ 28	-40 ... +120	45	SEP	-	-
BVE/BVS....	II	≥ 35		45	I	A	CE

Alco Keyword Register

Series	Description	Page
110 RB	2-Way Solenoid Valve	242
200 RB	2-Way Solenoid Valve	242
200 RH	2-Way Solenoid Valve	244
240 RA	2-Way Solenoid Valve	242
540 RA	2-Way Solenoid Valve	243
935	Liquid Injection Valve	233
A	Suction Accumulators	314
ACP	Hot Gas Bypass Regulator	253
ADK	Filter Drier	282
ADKS-Plus	Filter Drier Shell	286
AMI	Moisture/Liquid Indicator	297
AOK	Acid Test Kit	316
ASF	Suction Line Filter	292
ASD	Suction Line Filter Drier	292
B		
BFK	Bi-Flow Filter Drier	281
BTAS	Suction Line Filter and Filter Drier Shell	293
BVE / BVS, CVE / CVS	Ball Valves	315
C		
CPHE	Hot Gas Bypass Regulator	254
CSS	Compressor Soft Starter	198
CX2	Electrical Control Valves	153
CX4 .. CX7	High Pressure Expansion Valves	174
E		
EC2-3	Display Case Controller	182
EC2-5	Condenser and Condensing Unit Controller	185
EC3-3	Coldroom Controller	188
EC3-D13/D23	Driver for Digital Copeland™ compressors	192
EC3-D72/D73	Digital Superheat Controllers	180
EC3-X32/X33	Superheat Controllers	180
EX2	Electrical Control Valves	150
EX4 .. EX8	Electrical Control Valves	154
EXD-HP1/2	Stand-alone Superheat/Economizer Controller	194
EXD-TEVI	Economizer Controller for Tandem Compressors	196
EXD-U	Universal Driver Modules	181
EXM/EXL	Electrical Control Valves	149

Alco Keyword Register

Series	Description	Page
F		
FD 113	Differential Pressure Controls	272
FDB	Filter Driers	284
FDH	Filter Drier Shell	287
FDS-24	Filter-Drier Shells With Quick-Cap	288
FSE	Fan Speed Control Module	206
FSY	Electronic Fan Speed Controller	204
L		
	Liquid Injection Valve	231
LW4/5	Level Watch LW4 and LW5	309
M		
M36	3-Way Solenoid Valve	249
MIA / CIA	Moisture/Liquid Indicator	295
O		
OM3 / OM4	Oil Level Management System	301
OM5	Oil Level Management System	304
OW4 / OW5	Electronic Oil Level Monitoring	308
OS	Oil Separator	311
P		
PRC	Crankcase Pressure Regulator	257
PRE	Evaporator Pressure Regulator	256
PS1	Pressure Controls	262
PS2	Dual Pressure Controls	264
PS3	Pressure Controls	266
PS4	Pressure Switch	269
PT5	Pressure Transmitter	199
PT6	Pressure Transmitter	202
T		
	Thermo™-Expansion Valve	208
TI	Thermo Expansion Valve	210
TS1	Thermostat	276
TX3	Thermo Expansion Valve	218
TX6	Thermo Expansion Valve	220
Z		
ZZ	Thermo -Expansion Valve	228

1. DEFINITIONS:

In these Terms and Conditions of Sale, "Seller" means one of the three Emerson companies mentioned in the title; "Buyer" means the person, firm, company or corporation by whom the order is given; "Goods" means the goods (including any Software and Documentation, as defined in Clause 9) described in Seller's Acknowledgement of Order form; "Services" means the services described in Seller's Acknowledgement of Order Form; "Contract" means the written agreement (including these Terms and Conditions) made between Buyer and Seller for the supply of the Goods and/or provision of Services; "Contract Price" means the price payable to Seller by Buyer for the Goods and/or Services and "Seller Affiliate" means an Emerson Group company which is an affiliate within the meaning of Section 15 AktG (German Stock Corporation Act).

2. THE CONTRACT:

2.1 All orders must be in writing and are accepted subject to these Terms and Conditions of Sale. No terms or conditions put forward by Buyer and no representations, warranties, guarantees or other statements not contained in Seller's quotation or Acknowledgement of Order nor otherwise expressly agreed in writing by Seller shall be binding on Seller. **2.2** The Contract shall become effective only upon the date of acceptance of Buyer's order on Seller's Acknowledgement of Order form. If the details of the Goods or Services described in Seller's quotation differ from those set out in the Acknowledgement of Order Form the latter shall apply. **2.3** No alteration or variation to the Contract shall apply unless agreed in writing by both parties. However, Seller reserves the right to effect minor modifications and/or improvements to the Goods before delivery provided that the performance of the Goods is not adversely affected and that neither the Contract Price nor the delivery date is affected.

3. VALIDITY OF QUOTATION AND PRICES:

3.1 Unless previously withdrawn, Seller's quotation is open for acceptance within the period stated therein or, when no period is so stated, within thirty days after its date. **3.2** Prices are firm for delivery within the period stated in Seller's quotation and are exclusive of (a) Value Added Tax and (b) any similar and other taxes, duties, levies or other like charges arising outside Germany in connection with the performance of the Contract. **3.3** Prices (a) are for Goods delivered EXW (Ex works) Seller's shipping point, exclusive of freight, insurance and handling and (b) unless otherwise stated in the Seller's quotation, are exclusive of packing. If the Goods are to be packed, packing materials are non-returnable.

4. PAYMENT:

4.1 Payment shall be made: (a) in full without set-off, counterclaim or withholding of any kind (save where and to the extent that this cannot by law be excluded); and (b) in the currency of Seller's quotation within thirty days of receipt of invoice unless otherwise specified by Seller's Finance Department. Goods will be invoiced at any time after their readiness for dispatch has been notified to Buyer. Services will be invoiced monthly in arrears or, if earlier, upon completion. Without prejudice to Seller's other rights, Seller reserves the right to: (i) charge interest on any overdue sums at 8% above the base lending rate of Section 247 BGB (German Civil Code) during the period of delay; (ii) suspend performance of the Contract (including withholding shipment) in the event that Buyer fails or in Seller's reasonable opinion it appears that Buyer is likely to fail to make payment when due under the Contract or any other contract; and (iii) under the same conditions require reasonable security for payment. **4.2** Customer may set off counterclaims only if recognized or non-appealable. A right of retention may be exercised by Customer only if as it concerns the same contractual relationship.

5. DELIVERY PERIOD:

5.1 Unless otherwise stated in Seller's quotation, all periods stated for delivery or completion run from the Effective Date and are to be treated as estimates only not involving any contractual obligations. **5.2** If Seller is delayed in or prevented from performing any of its obligations under the Contract due to the acts or omissions of Buyer or its agents (including but not limited to failure to provide specifications and/or fully dimensioned working drawings and/or such other information as Seller reasonably requires to proceed expeditiously with its obligations under the Contract), the delivery/completion period and the Contract Price shall both be adjusted accordingly. **5.3** If delivery is delayed due to any act or omission of Buyer, or if having been notified that the Goods are ready for dispatch, Buyer fails to take delivery or provide adequate shipping instructions, Seller shall be entitled to place the Goods into a suitable store at Buyer's expense. Upon placing the Goods into the store, delivery shall be deemed to be complete, risk in the Goods shall pass to Buyer and Buyer shall pay Seller accordingly.

6. FORCE MAJEURE:

6.1 The Contract (other than Buyer's obligation to pay all sums due to Seller in accordance with the Contract) shall be suspended, without liability, in the event and to the extent that its performance is prevented or delayed due to any circumstance beyond the reasonable control of the party affected, including but not limited to: Act of God, war, armed conflict or terrorist attack, riot, fire, explosion, accident, flood, sabotage; governmental decisions or actions (including but not limited to prohibition of exports or re-exports or the failure to grant or the revocation of applicable export licenses), or labor trouble, strike, lockout or injunction. Seller shall have no obligation to supply hardware, software or technology or to provide services in the absence of government permits or fulfillment of statutory conditions of exemption from such permits within the framework of import and export control (in particular, according to the regulations applicable in the United States, the European Union and the jurisdiction in which Seller has its registered office or from which components of the Goods are supplied) and the underlying circumstances could not be foreseen by Seller and are outside of Seller's sphere of influence. In the event of revocation of issued government permits or in the event of a change in the applicable statutory import and export control regulations such that Seller is prevented from fulfilling the contract, Seller is discharged from the contractual obligation without any liability of Seller. **6.2** If either party is delayed or prevented from performance of its obligations by reason of this Clause for more than 180 consecutive calendar days, either party may terminate the then unperformed portion of the Contract by notice in writing given to the other party, without liability provided that Buyer shall be obliged to pay the reasonable cost and expense of any work in progress and to pay for all Goods delivered and Services performed as at the date of termination.

7. INSPECTION, TESTING, AND CALIBRATION:

7.1 Goods will be inspected by Seller or manufacturer and, where practicable, submitted to Seller's or manufacturer's standard tests before dispatch. Any additional tests or inspection (including inspection by Buyer or its representative, or tests in the presence of Buyer or its representative and/or calibration) or the supply of test certificates and/or detailed test results shall be subject to Seller's prior written agreement and Seller reserves the right to charge therefor; if Buyer or its representative fails to attend such tests, inspection and/or calibration after seven days' notice that the Goods are ready therefor, the tests, inspection and/or calibration will proceed and shall be deemed to have been made in the presence of Buyer or its representative and the Seller's statement that the Goods have passed such testing and/or inspection and/or have been calibrated shall be conclusive. **7.2** Buyer's warranty rights are subject to Buyer's proper compliance with Buyer's inspection and complaint obligations set forth in Section 377 of the German Commercial Code (HGB).

8. DELIVERY, RISK & TITLE:

8.1 Unless otherwise expressly stated in the Contract, the Goods will be delivered Carriage Paid To (CPT) the destination named in the Contract; freight, packing and handling will be charged at Seller's standard rates. Risk of loss of or damage to the Goods shall pass to Buyer upon delivery as aforesaid and Buyer shall be responsible for insurance of the Goods after risk has so passed. Alternatively, if it is expressly stated in the Contract that Seller is responsible for the insurance of the Goods after their delivery to the carrier, such insurance will be charged at Seller's standard rates. "Ex-works", "FCA", "CPT" and any other delivery terms used in the Contract shall be defined in accordance with the latest version of Incoterms. **9. DOCUMENTATION AND SOFTWARE:**

9.1 Title to and ownership of the copyrights in software and/or firmware incorporated into or provided for use with the Goods ("Software") and documentation supplied with the Goods ("Documentation") shall remain with the relevant Seller Affiliate (or such other party as may have supplied the Software and/or Documentation to Seller) and is not transferred hereby to Buyer. **9.2** Except as otherwise provided herein, Buyer is hereby granted a non-exclusive, royalty-free license to use the Software and Documentation in conjunction with the Goods, provided that and for so long as the Software and Documentation are not copied (unless expressly authorized by applicable law) and Buyer holds the Software and Documentation in strict confidence and does not disclose them to others, or permit others to have access to them (other than Seller's standard operating and maintenance manuals). Buyer may transfer the foregoing license to another party which purchases, rents or leases the Goods, provided the other party accepts and agrees in writing to be bound by the conditions of this Clause 9.

9.3 Notwithstanding Sub-clause 9.2, Buyer's use of certain Software, (as specified by Seller and including but not limited to control system and AMS Software) shall be governed exclusively by the applicable Seller Affiliate or third party license agreement. **9.4** Seller and Seller Affiliates shall retain ownership of all inventions, designs and processes made or evolved by them and save as set out in this Clause 9 no rights in intellectual property are hereby granted.

10. LIABILITY FOR DEFECTS OF QUALITY

10.1 Seller warrants that upon passing of the risk the Goods and Services will have the quality agreed upon. Unless otherwise agreed, the quality agreed upon shall meet Seller's specifications as valid and published at the time of the order confirmation. **10.2** If, upon passing of the risk, the Goods or Services do not have the quality agreed upon, Seller warrants to provide subsequent performance by either, at its option, repairing or replacing the concerned parts (subsequent rectification) or by replacing the Goods or Services by such Goods or Services which are free from defects (subsequent delivery). **10.3** Seller may rectify any defect several times and may decide at its discretion to change from rectification to subsequent delivery. Seller shall be responsible for all costs incurred in connection with its subsequent performance, especially the transport, shipping, labor and material cost, unless such costs are incurred as a result of the Goods being taken to a place other than the place of performance.

10.4 Buyer may set a reasonable period of at least four (4) weeks to Seller for him to provide subsequent performance and, if subsequent performance fails during such period, may demand reduction of the Contract Price after expiry of that period or, unless the defect is insignificant, may rescind the Contract. Damages may only be claimed in line with Clause 14. **10.5** Any claims and rights based on defects will become time-barred, except in the case of injury, after expiry of twelve (12) months since taking into operation of the Goods, however no later than eighteen (18) months since delivery. Claims to damages based on defects will become time-barred after expiry of the statutory period if they result from a violation of another's life, health or body, or from Seller's gross negligence. **10.6** Seller assumes no warranty for normal wear and tear, material provided by Buyer, processing of the Goods made by Buyer, damage due to improper storage, installation or operation or due to inadequate maintenance, or damage resulting from any modification or repair not approved beforehand by Seller in writing. Seller will not be liable where any non-authorized software or non-authorized spare or replacement parts are used. Any costs incurred by Seller for examining and removing such defects will be borne by Buyer upon demand. Buyer will always be responsible alone for the completeness and correctness of any information provided by it. **10.7** Regarding products or Services sourced by Seller from a third party (other than a Seller Affiliate) for resale to Buyer, Seller assigns to Buyer all warranty rights against such third party. In addition, Seller remains obliged to assume the guarantee set forth the preceding clauses towards Buyer, however, only under the restriction that Buyer has beforehand unsuccessfully tried to execute the assigned warranty rights against the third party.

11. LIABILITY FOR PROPRIETARY RIGHTS INFRINGEMENTS

11.1 Seller warrants that upon passing of the risk no patents or other proprietary rights of third parties exist which may be claimed with respect to the Goods or Services if these are used as intended. Clauses 10.2 to 10.5 and 10.7 shall apply correspondingly. **11.2** Seller's liability shall be excluded where a third party patent or proprietary right is infringed because Seller has adhered to a design provided by Buyer or has complied with an instruction given by Buyer, or because the Goods are used in a manner, for a purpose, in a country, or in connection with other goods or services, without this having been communicated to Seller before execution of the Contract. **11.3** During the period of Seller's warranty, Buyer has the obligation to inform Seller in writing as promptly as possible in the event that a third party claims any patent or other proprietary right or asserts any claims in or out of court with respect to the Goods or Services. Before recognizing any claim advanced by a third party in or out of court, Buyer shall give Seller the opportunity to comment. At its request, Seller shall be given the authority to handle the negotiations or legal dispute with such third party at its own cost and responsibility. Buyer shall be liable to Seller for any damage sustained by it as a result of a culpable violation of said obligations. **11.4** Buyer warrants that the use of a design provided by it or compliance with an instruction given by it will not lead to Seller infringing any patents or other proprietary rights when performing its contractual obligations. Buyer agrees to indemnify and hold Seller harmless against any reasonable cost and damages incurred by Seller as a result of Buyer's breach of this warranty.

12. DAMAGES

12.1 Seller shall be liable to Buyer only for damage caused with intent or gross negligence. In the event of breach of material contractual obligations, Seller shall, however, be liable for each fault of its personnel (statutory representatives, executive employees and other persons employed in the performance of its obligations) causing damage. **12.2** Except in case of intentional causation of damage by personnel of Seller or causation of damage with gross negligence by statutory representatives or executive employees of Seller, Seller shall not be liable for compensation for indirect damage and, in particular, Seller shall not be liable for compensation for loss of profit, unless such damage is covered by the protective purpose of a warranty explicitly assumed. **12.3** Except in case of intentional causation of damage by personnel of Seller or causation of damage with gross negligence by statutory representatives or executive employees of Seller, the liability of Seller shall, in each case, be limited in terms of amount to the damage which is typically foreseeable in the time of conclusion of the contract. **12.4** Claims to damages which result from the violation of another's life, body or health, from the violation of a guaranty given by Seller expressly in writing as well as damage claims under the Product Liability Act shall remain unaffected. **13. STATUTORY AND OTHER REGULATIONS:**

13.1 If Seller's obligations under the Contract shall be increased or reduced by reason of the making or amendment after the date of Seller's quotation of any law or any order, regulation or bye-law having the force of law that shall affect the performance of Seller's obligations under the Contract, the Contract Price and delivery period shall be adjusted accordingly and/or performance of the Contract suspended or terminated, as appropriate. A price adjustment shall not be implemented if the delivery is to be carried out within 4 months after the closing of the Contract. **13.2** Except to the extent otherwise required by applicable law, Seller shall have no responsibility for the collection, treatment, recovery or disposal of (i) the Goods or any part thereof when they are deemed by law to be 'waste' or (ii) any items for which the Goods or any part thereof are replacements. If Seller is required by applicable law, including waste electrical and electronic equipment legislation, European Directive 2002/96/EC (WEEE) and related legislation in EU Member States, to dispose of 'waste' Goods or any part thereof, Buyer shall, unless prohibited by applicable law, pay Seller, in addition to the Contract Price, either (i) Seller's standard charge for disposing of such Goods or (ii) if Seller does not have such a standard charge, Seller's costs (including all handling, transportation and disposal costs and a reasonable mark-up for overhead) incurred in disposing of such Goods. **13.3** Buyer's personnel shall, whilst on Seller's premises, comply with Seller's applicable site regulations and Seller's reasonable instructions, including but not limited to those relating to safety, security and electrostatic discharge.

14. COMPLIANCE WITH LAWS

Buyer agrees that all applicable import, export control and sanctions laws, regulations, orders and requirements, as they may be amended from time to time, including without limitation those of the United States, the European Union and the jurisdictions in which Seller and Buyer are established or from which items may be supplied, and the requirements of any licenses, authorizations, general licenses or license exceptions relating thereto will apply to its receipt and use of hardware, software, services and technology. In no event shall Buyer use, transfer, release, export or re-export any such hardware, software or technology in violation of such applicable laws, regulations, orders or requirements or the requirements of any licenses, authorizations or license exceptions relating thereto. Buyer agrees furthermore that it shall not engage in any activity that would expose the Seller or any of its affiliates to a risk of penalties under laws and regulations of any relevant jurisdiction prohibiting improper payments, including but not limited to bribes, to officials of any government or of any agency, instrumentality or political subdivision thereof, to political parties or political party officials or candidates for public office, or to any employee of any customer or supplier. Buyer agrees to comply with all appropriate legal, ethical and compliance requirements. **15. DEFAULT, INSOLVENCY AND CANCELLATION:**

Seller shall be entitled, without prejudice to any other rights it may have, to cancel the Contract forthwith, wholly or partly, by notice in writing to Buyer, if Buyer is in default of any of its obligations under the Contract and fails, within 30 (thirty) days of the date of Seller's notification in writing of the existence of the default, either to rectify such default if it is reasonably capable of being rectified within such period or, if the default is not reasonably capable of being rectified within such period, to take action to remedy the default. **16. SUPPLEMENTARY TERMS AND CONDITIONS:**

If the Goods comprise or include a control system, Seller's Supplementary Terms and Conditions Applicable to the Supply of Control Systems and Related Services shall apply to the control system and related services only. Such Supplementary Terms and Conditions shall take precedence over these Standard Terms and Conditions of Sale; copies are available from Seller upon request. **17. MISCELLANEOUS:**

17.1 No waiver by either party with respect to any breach or default or of any right or remedy and no course of dealing, shall be deemed to constitute a continuing waiver of any other breach or default or of any other right or remedy, unless such waiver be expressed in writing and signed by the party to be bound. **17.2** If any clause, sub-clause or other provision of the Contract is invalid or unenforceable, this shall not affect the validity of the remainder of the Contract. Should one of the clauses be invalid or unenforceable, the parties obligate themselves to replace the invalid or unenforceable clause by such a clause which comes closest to the intended economic purpose of the invalid clause. **17.3** Buyer shall not be entitled to assign its rights or obligations hereunder without the prior written consent of Seller. **17.4** Seller enters into the Contract as principal. Buyer agrees to look only to Seller for due performance of the Contract. **17.5** GOODS AND SERVICES PROVIDED HEREUNDER ARE NOT SOLD OR INTENDED FOR USE IN ANY NUCLEAR OR NUCLEAR RELATED APPLICATIONS. Buyer (i) accepts Goods and Services in accordance with the foregoing restriction, (ii) agrees to communicate such restriction in writing to any and all subsequent purchasers or users and (iii) agrees to defend, indemnify and hold harmless Seller and Seller's Affiliates from any and all claims, losses, liabilities, suits, judgements and damages, including incidental and consequential damages, arising from use of Goods and Services in any nuclear or nuclear related applications, whether the cause of action be based in tort, contract or otherwise, including allegations that the Seller's liability is based on negligence or strict liability. **17.6** The Contract shall in all respects be construed in accordance with the laws of the Federal Republic of Germany excluding, however, any effect on such laws of the 1980 Vienna Convention on Contracts for the International Sale of Goods, and to the fullest extent permitted by law, shall be without regard to any conflict of laws or rules which might apply the laws of any other jurisdiction. All disputes arising out of the Contract shall be subject to the exclusive jurisdiction of the Berlin courts. However, Seller is entitled to sue Buyer in the court of Buyer's residence as well. **17.7** The headings to the Clauses and paragraphs of the Contract are for guidance only and shall not affect the interpretation thereof. **17.8** All notices and claims in connection with the Contract must be in writing.



BENELUX

Josephinastraat 19
NL-6462 EL Kerkrade
Tel. +31 77 324 02 34
Fax +31 77 324 02 35
benelux.sales@emerson.com

UK & IRELAND

Unit 17, Theale Lakes Business Park
Reading, Berkshire RG7 4GB
Tel: +44 1189 83 80 00
Fax: +44 1189 83 80 01
uk.sales@emerson.com

BALKAN

Selska cesta 93
HR-10 000 Zagreb
Tel. +385 1 560 38 75
Fax +385 1 560 38 79
balkan.sales@emerson.com

GERMANY, AUSTRIA & SWITZERLAND

Senefelder Str. 3
DE-63477 Maintal
Tel. +49 6109 605 90
Fax +49 6109 60 59 40
ECTGermany.sales@emerson.com

SWEDEN, DENMARK, NORWAY & FINLAND

Norra Koxåsvägen 7
SW-443 38 Lerum
Tel. +46 725 386486
nordic.sales@emerson.com

UKRAINE

Kurenevskiy lane, 12, build. A, office 302
UA-04073 Kiev
T +38 044 492 99 24 Ext. 232
F +38 044 492 99 28
Andrey.Gladchenko@emerson.com

FRANCE, GREECE & MAGHREB

8, Allée du Moulin Berger
FR-69134 Ecully Cédex
Tel. +33 4 78 66 85 70
Fax +33 4 78 66 85 71
mediterranean.sales@emerson.com

EASTERN EUROPE & TURKEY

Pascalstr. 65
DE-52076 Aachen
Tel. +49 2408 929 0
Fax +49 2408 929 525
easterneurope.sales@emerson.com

ROMANIA

Tel. +40 374 13 23 50
Fax +40 374 13 28 11
Ancuta.Ionescu@Emerson.com

ITALY

Via Ramazzotti, 26
IT-21047 Saronno (VA)
Tel. +39 02 96 17 81
Fax +39 02 96 17 88 88
italy.sales@emerson.com

POLAND

Szturmowa 2
PL-02678 Warsaw
Tel. +48 22 458 92 05
Fax +48 22 458 92 55
poland.sales@emerson.com

MIDDLE EAST & AFRICA

PO Box 26382
Jebel Ali Free Zone - South, Dubai - UAE
Tel. +971 4 811 81 00
Fax +971 4 886 54 65
mea.sales@emerson.com

SPAIN & PORTUGAL

C/ LLull, 321 (Edifici CINC)
ES-08019 Barcelona
Tel. +34 93 412 37 52
Fax +34 93 412 42 15
iberica.sales@emerson.com

RUSSIA & CIS

Letnikovskaya 10, Bld. 2, floor 5
RU-115114 Moscow
Tel. +7 495 981 98 11
Fax +7 495 981 98 16
ECT.Holod@emerson.com

For more details, see www.emersonclimate.eu

Connect with us: facebook.com/EmersonClimateEurope



Emerson Climate Technologies - European Headquarters - Pascalstrasse 65 - 52076 Aachen, Germany
Tel. +49 (0) 2408 929 0 - Fax: +49 (0) 2408 929 570 - Internet: www.emersonclimate.eu

The Emerson Climate Technologies logo is a trademark and service mark of Emerson Electric Co. Emerson Climate Technologies Inc. is a subsidiary of Emerson Electric Co. Copeland is a registered trademark and Copeland Scroll is a trademark of Emerson Climate Technologies Inc.. All other trademarks are property of their respective owners. Emerson Climate Technologies GmbH shall not be liable for errors in the stated capacities, dimensions, etc., as well as typographic errors. Products, specifications, designs and technical data contained in this document are subject to modification by us without prior notice. Illustrations are not binding.
© 2015 Emerson Climate Technologies, Inc.

