

TAC

**A** AV24...-R

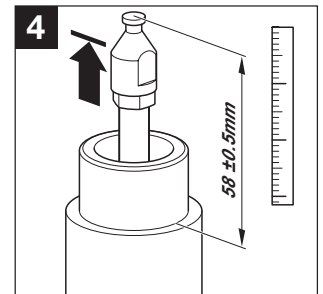

70133-00001A

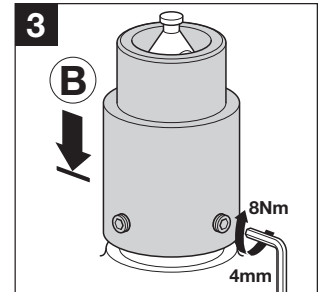
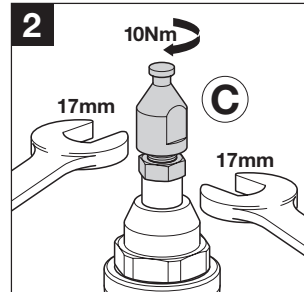
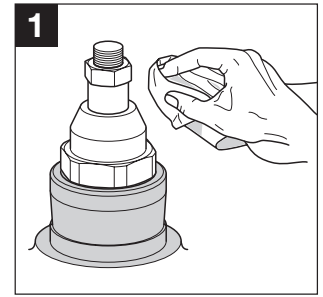
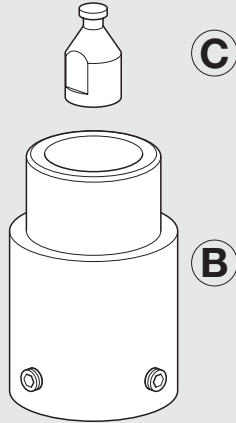

TAC	DN	t
-----	----	---

	V221	65 ... 150	2 ... 150°C
	V265	40 / 65	
	V295	40 / 65	
	V395-1	40 ... 100	2 ... 150°C

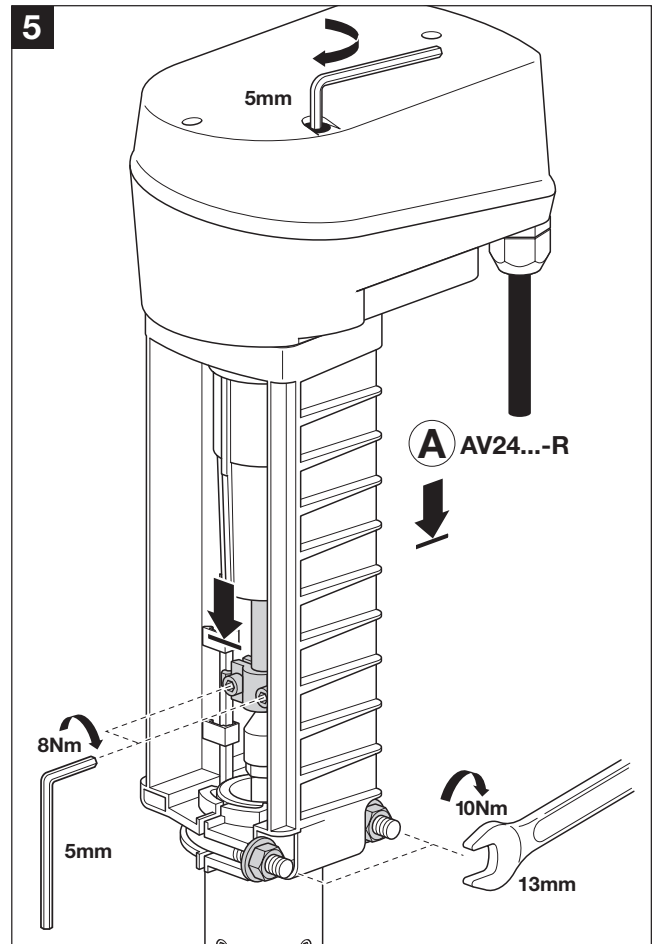

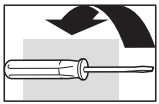

AV24-3-R / AV230-3-R

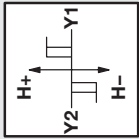

→ 7,5s/mm

→ 4,5s/mm

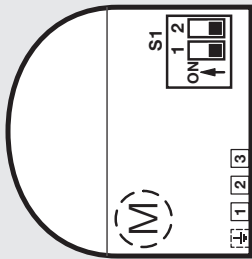
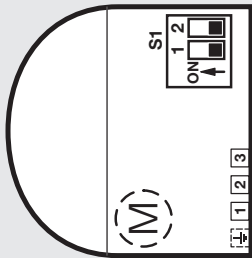

AV24-MFT2-R / AV24LON-R

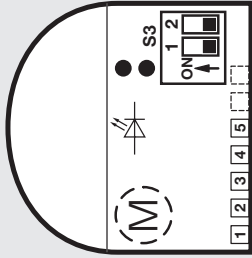
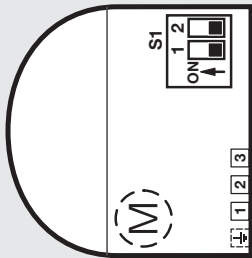
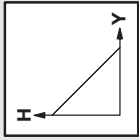
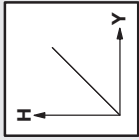

TAC

S1.1

S1.2

S1.1

S1.2

S3.1

S3.2

S3.1

S3.2



V221  
V265  
V295

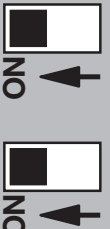
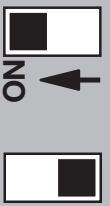
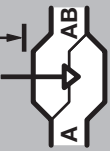

V395-1



V221 / V265 / V295  
V395-1

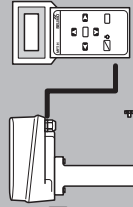

F < 1000N  
F < 1200N

MFT-H F=50%  
MFT-H F=60%