

2. + 6. KN-1
Product Information
Actuators for LONWORKS[®]

KN



2. + 6. KN-... Actuators for LonWorks®

Actuators that can be linked directly to a LonWorks® network:

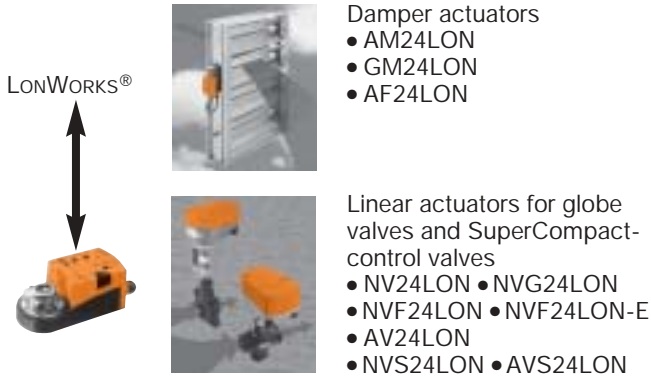





2. + 4. + 6. UK-... UK24LON Gateway MP/LonWorks®

MFT.../MFT2... actuators that can be linked to a LonWorks® network via the UK24LON Gateway unit:





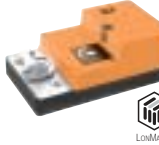





10593309

Damper actuators for LONWORKS®

	Damper actuators	AM24LON  18 Nm AC / DC 24 V	GM24LON  36 Nm AC / DC 24 V	AF24LON  15 Nm with safety function AC / DC 24 V
	Technical data see Page 5			

Valve actuators for LONWORKS®

	Valve actuators for Type H... globe valves	NV24LON  1000 N ¹⁾ / 800 N ²⁾ AC / DC 24 V	NVG24LON  1600 N AC / DC 24 V	NVF24LON  800 N with emergency control function: retracting AC / DC 24 V	NVF24LON-E  800 N with emergency control function: extending AC / DC 24 V	AV24LON  2000 N AC / DC 24 V
	¹⁾ Closing force ²⁾ Blocking force Technical data see Page 6					

	Valve actuators for SuperCompact-control valves	NVS24LON  1200 N AC / DC 24 V	AVS24LON  2000 N AC / DC 24 V
	Technical data see Page 7		

Contents

Actuators for linking to LONWORKS®	2
Product overview	3
Functional Profile accord. to LONMARK®	4
Damper actuators for LONWORKS®	5
Valve actuators for LONWORKS® for Type H... globe valves	6
Valve actuators for LONWORKS® for S6... SuperCompact-control valves	7
Wiring diagram for LON actuators	8
MFT Parameter Assignment Devices	8
Manual Device: MFT-H	9
PC-Tool MFT-P	10

Functional Profile according to LONMARK®

Belimo damper actuators and valve actuators with a LON capability have been certified by LONMARK®. The actuator functions are made available to the LONWORKS® network as standard network variables according to LONMARK®. Node Object #0 and Damper Actuator Object #8110 are implemented in all damper and valve actuators.

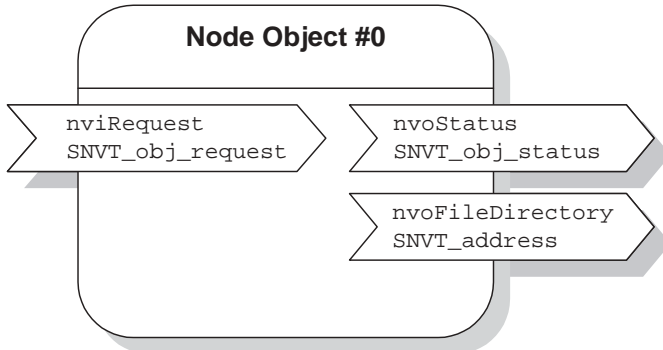

Node Object #0

The node object contains the functions object status and object request.

nviRequest

SNVT_obj_request

Input variable for requesting the status of a particular object in the node.

nvoStatus

SNVT_obj_status

Output variable which gives the actual status of a particular object in the node.

nvoFileDirectory

SNVT_address

Output variable which shows information in the address area of the Neuron chip.

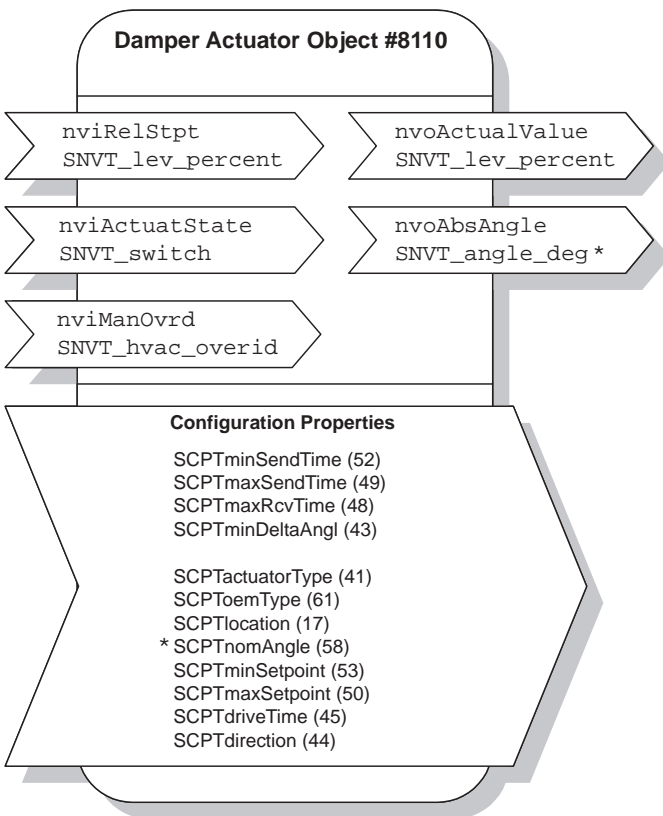

Damper Actuator Object #8110

The actuator object shows the functions of the LON actuators from the point of view of the LONWORKS® network.

nviRelStpt

SNVT_lev_percent

This input variable provides the actuator with the reference position. The variable is normally linked from the LON to the output variable of an HVAC controller.

nviActuateState

SNVT_switch

This input variable provides the actuator with a preset position. *Note on priority:* The last variable to be active (`nviActuatorState` or `nviRelStpt`) takes priority.

nviManOvrdr

SNVT_hvac_overid

This input variable allows the actuator to be overridden manually to a particular position (the function is only active if preceded by `RQ_OVERRIDE`). This function would typically be used when commissioning an installation.

nvoActualValue

SNVT_lev_percent

This output variable shows the current actual position of the actuator and can be used for resetting control circuits or for indicating positions.

nvoAbsAngle

SNVT_angle_deg



This output variable shows the current actual angle of rotation of a damper actuator or the damper blade and can be used for indicating positions or for servicing purposes (this SNVT is inactive with valve actuators).

* Note: `SNVT_angle_deg` is not valid (indicate invalid value) in the valve actuators (NV... and AV...). In this case `SCPTnom-Angle(58)` is also invalid.

Damper actuators for LONWORKS®



Technical data

	AM24LON	GM24LON	AF24LON
For further general technical data see Product Information 2. + 6. MFT2			
Data for LONWORKS®			
Certified for LONMARK®	•	•	•
Processor Neuron 3120®	•	•	•
Transceiver FTT-10A, compatible with LPT-10	•	•	•
Functional Profile LONMARK® #8110; see Page 4	•	•	•
Plug-In available, suitable for LONMAKER 2.0 / 3.0	•	•	•
Service key and status LED conforming to LONMARK® Guidelines	•	•	•
Lead lengths, cable specifications and topology of the LONWORKS® network in accordance with Echelon recommendations	•	•	•
General actuator data			
Torque	18 Nm	36 Nm	15 Nm
Damper driver with universal spindle clamp	•	•	•
Safety function (spring return)	-	-	•
Max. angle of rotation	95°	95°	95°
Nominal voltage	AC 24 V 50/60 Hz, DC 24 V	•	•
Tolerance range	AC 19.2...28.8 V, DC 21.6...28.8 V	•	•
For wire sizing	6 VA	9 VA	11 VA
Peak inrush current	Imax @ t[ms]	8.3 A @ 5 ms	8.3 A @ 5 ms
Power consumption			
- running	3 W	4.1 W	6.5 W
- stationary	1.7 W	2.5 W	3 W
Connecting lead	1 m long, 5 x 1.5 mm ²	•	•
Running time	motor	150 s	150 s
Running time	spring return	-	≈16 s

Notes

Further technical data:

The basic design of the actuators is identical to the corresponding MFT(2) type. Therefore, if further technical data is required refer to Product Information 2. + 6. MFT2 (general technical data, dimensions, installation instructions, etc.).

Parameter assignment:

Using an MFT parameter assignment device (PC-Tool MFT-P or Manual Parameter Assignment Device MFT-H) it is a very

simple matter to edit any parameters for specific actuators. The adjustable functions and ranges depend on the particular actuator concerned.

Adjustable parameters:

- Electronic angle of rotation limiting
- Torque: (The rated torque can be reduced to 75%, 50% or 25%. With the AF24LON type – spring return – the torque cannot be reduced).
- Direction of operation reversible.

- Running time (motor): When running times are shorter than the basic value, the values of torque (Nm) and sound power level (dB) of the actuator may be different. It is very important to refer to the corresponding function curves in the Product Information brochure for MFT(2) actuators (2. + 6. MFT2).
- Functional test or adaption can be started.

Wiring diagram/MFT Parameter Assignment Devices see Pages 8 to 10.

Valve actuators for LONWORKS®, for Type H... globe valves



Technische Daten

	NV24LON	NVG24LON	NVF24LON	NVF24LON-E	AV24LON
For further general technical data see Product Information 2. + 6. MFT2					
For the technical data of the corresponding Type H... valves see Product Information 6. H					
Data for LONWORKS®					
Certified for LONMARK®	•	•	•	•	•
Processor Neuron 3120®	•	•	•	•	•
Transceiver FTT-10A, compatible with LPT-10	•	•	•	•	•
Functional Profile LONMARK® #8110; see Page 4	•	•	•	•	•
Plug-In, available, suitable for LONMAKER 2.0 / 3.0	•	•	•	•	•
Service key and status LED conforming to LONMARK® Guidelines	•	•	•	•	•
Lead lengths, cable specifications and topology of the LONWORKS® network in accordance with Echelon recommendations	•	•	•	•	•
General actuator data					
Actuating force (Closing force ¹⁾ , Blocking force ²⁾)	1000 N ¹⁾ /800 N ²⁾	1600 N	800 N	800 N	2000
Nominal stroke	20 mm	20 mm	20 mm	20 mm	40 mm
Suitable for Type H	DN 15...80	DN 15...80	DN 15...80	DN 15...80	DN 65...150
Emergency control function (spring return)	–	–	retracting	extending	–
Emergency control time	–	–	<1.5 s/mm	<1.5 s/mm	–
Nominal voltage	AC 24 V 50/60 Hz, DC 24 V	•	•	•	•
Tolerance range	AC 19.2...28.8 V, DC 21.6...28.8 V	•	•	•	•
For wire sizing	5 VA	5 VA	10 VA	10 VA	12 VA
Power consumption	3 W	3 W	5.5 W	5.5 W	6.5 W
Connecting lead	1 m long, 5 x 1.5 mm ²	•	•	•	•
Running time 150 s	•	•	•	•	•

Notes

Further technical data for valve actuators:

The basic design of the actuators is identical to the corresponding MFT(2) type. Therefore, if further technical data is required refer to Product Information 2. + 6. MFT2 (general technical data, dimensions, installation instructions, etc.).

Parameter assignment:

Using an MFT parameter assignment device (PC-Tool MFT-P or Manual Parameter Assignment Device MFT-H) it is a very simple matter to edit any parameters for

specific actuators. The adjustable functions and ranges depend on the particular actuator concerned.

Adjustable parameters:

- Electronic stroke limiting
- Actuating force: (This can be reduced to 75%, 50% or 25%).
With the NVF24LON and NVF24LON-E types – spring return – the actuating force cannot be reduced.
- Direction of stroke and closing point selection reversible (slide switch).
- Running time (motor): When running

times are shorter than the basic value, the values of actuating force (N) and sound power level (dB) of the actuator may be different. It is very important to refer to the corresponding function curves in the Product Information brochure for MFT(2) actuators (2. + 6. MFT2).



- Functional test or adaption can be started.

Wiring diagram / MFT Parameter Assignment Devices see Pages 8 to 10.

Valve actuators for LONWORKS® for Type S6... SuperCompact-control valves



Technical data

	NVS24LON	AVS24LON
For further general technical data see Product Information 2. + 6. MFT2		
For the technical data of the corresponding Type S6... valves see Product Information 6. S		
Data for LONWORKS®		
Certified for LONMARK®	•	•
Processor Neuron 3120®	•	•
Transceiver FTT-10A, compatible with LPT-10	•	•
Functional Profile LONMARK® #8110, see Page 4	•	•
Plug-In, available, suitable for LONMAKER 2.0 / 3.0	•	•
Service key and status LED conforming to LONMARK® Guidelines	•	•
Lead lengths, cable specifications and topology of the LONWORKS® network in accordance with Echelon recommendations	•	•
General actuator data		
Actuating force	1200 N	2000 N
Stroke	23 mm	53 mm
Suitable for Type S... globe valves	S625...S680	S650...S6150
Nominal voltage	AC 24 V 50/60 Hz, DC 24 V	•
Tolerance range	AC 19.2...28.8 V, DC 21.6...28.8 V	•
For wire sizing	5 VA	10 VA
Power consumption	3 W	6 W
Connecting lead	1 m long, 5 x 1.5 mm ²	•
Running time 150 s	•	•

Notes

Further technical data for valve actuators:

The basic design of the actuators is identical to the corresponding MFT(2) type. Therefore, if further technical data is required refer to Product Information 2. + 6. MFT2 (general technical data, dimensions, installation instructions, etc.).

Parameter assignment:

Using an MFT parameter assignment device (PC-Tool MFT-P or Manual Parameter Assignment Device MFT-H) it is a very simple matter to edit any parameters for

specific actuators. The adjustable functions and ranges depend on the particular actuator concerned.

Adjustable parameters:

- Electronic stroke limiting
- Actuating force: (This can be reduced to 75%, 50% or 25%).
- Direction of stroke reversible.
- The closing point must not be altered (slide switch).
- Running time (motor): When running times are shorter than the basic value, the values of actuating force (N) and

sound power level (dB) of the actuator may be different. It is very important to refer to the corresponding function curves in the Product Information brochure for MFT(2) actuators (2. + 6. MFT2).

- Functional test or adaption can be started.

Wiring diagram/MFT Parameter Assignment Devices see Pages 8 to 10.

Wiring diagram for LON actuators

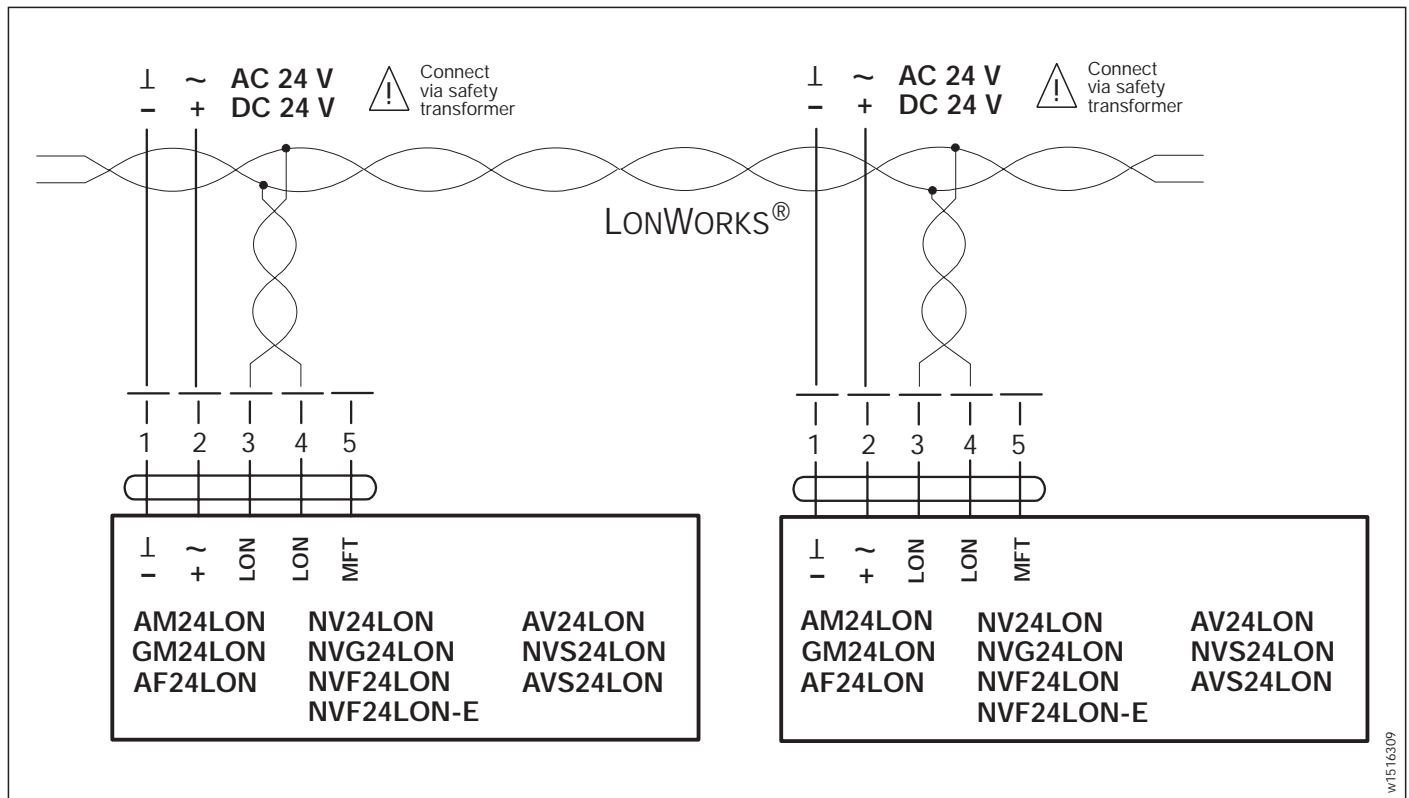

MFT parameter assignment devices for LON actuators

MFT parameter assignment devices

The MFT parameter assignment devices (PC-Tool MFT-P or Manual Parameter Assignment Device MFT-H) are used for the on-site editing of individual parameters of LON actuators for the purpose of application and servicing. Running time and torque or actuating force are typical parameters that can be edited. When the LON actuators are being manufactured at the factory they are parameterised with basic values for standard applications.

Adjustable functions, depending on the actuator

A specific configuration table depending on the particular application is stored in each actuator. The table determines which menu items in the MFT parameter assignment device can be selected and which values can be edited. When an MFT parameter assignment device (PC-Tool MFT-P or Manual Parameter Assignment Device MFT-H) is connected to an actuator the device automatically reads out the configuration table from the actuator.



Inactive display

Any parameters and menu items that cannot be accessed in a particular actuator are blanked out by the Manual Parameter Assignment Device MFT-H or, in the case of the PC-Tool MFT-P, are greyed out.

Functional testing with Belimo MFT parameter assignment devices

The MFT parameter assignment devices can also be used for testing the proper functioning of LON actuators. The parameterized values can either be read out with the device or it can be used to test the actuator functions.

Do not forget the operating instructions

Before using an MFT parameter assignment device for the first time it is very important to consult the operating instructions that come with it (in the case of the Manual Parameter Assignment Device MFT-H these are hardcopy instructions and in the case of the PC-Tool MFT-P it is a Help File).

Note on the communications setup PC-Tool MFT-P << >> LON actuator

Once a LON actuator has been connected to the power supply the PC-Tool has only 30 seconds to establish communications with the actuator. After that, the actuator automatically connects itself

to the LONWORKS® network. However, if the PC-Tool does establish communications with the actuator within that period of time they will remain in operation for as long as necessary. As long as the PC-Tool is communicating with the actuator there can be no exchange of data bet-

ween LONWORKS®, and the actuator. From what has been described it is possible to derive a sequential procedure for the communications circuitry as shown in Diagrams 3 and 4.

Diagram 3
Connecting the PC-Tool MFT-P

Typical application:

Parameterizing a LON actuator when it has already been incorporated into an installation.

Procedure for setting up communications:

1. Connect up as shown in the diagram. Do not connect Core 2 of the LON actuator to the 24 V AC or DC power supply yet (connection is identified by a switch symbol).
2. Start up the PC-Tool and select the <<PP>> toolbar in the address field.
3. Power up the LON actuator, i.e. by connecting Core 2, identified by a switch symbol, to 24 V AC or DC.
4. Communications between the PC-Tool and the LON actuator are now established.

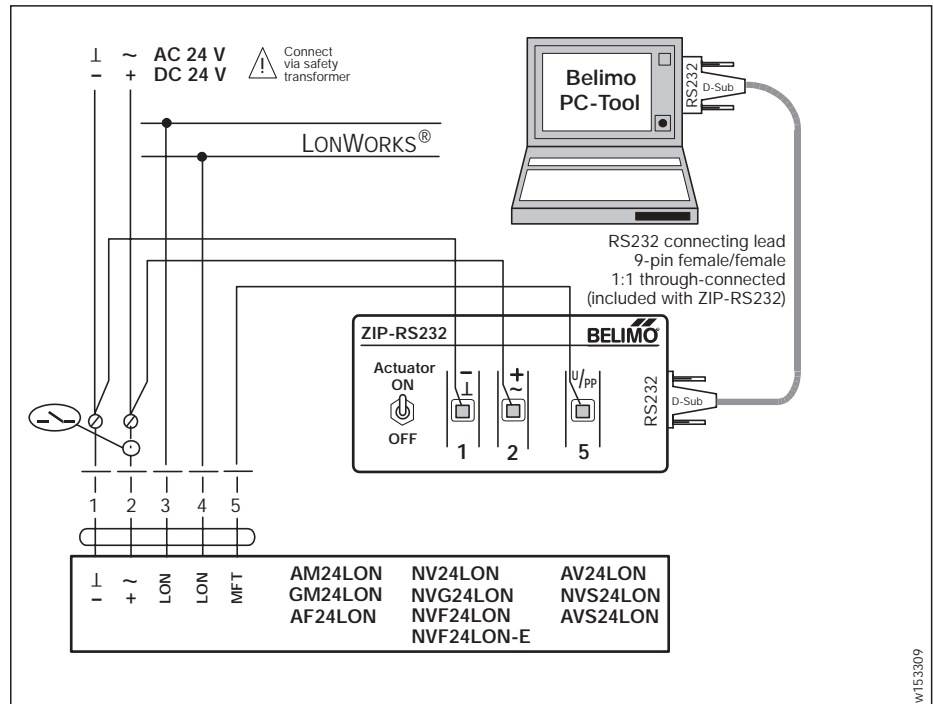

Diagram 4
Connecting the PC-Tool MFT-P

Typical application:

Parameterizing a LON actuator before it is incorporated into an installation.

Procedure for setting up communications:

1. Set the <<Actuator>> switch on the ZIP-RS232 unit to the OFF position and connect up as shown in the diagram.
2. Start up the PC-Tool and select the <<PP>> toolbar in the address field.
3. Power up the LON actuator, i.e. set the <<Actuator>> switch on the ZIP-RS232 unit, identified by a switch symbol, to the ON position.
4. Communications between the PC-Tool and the LON actuator are now established.

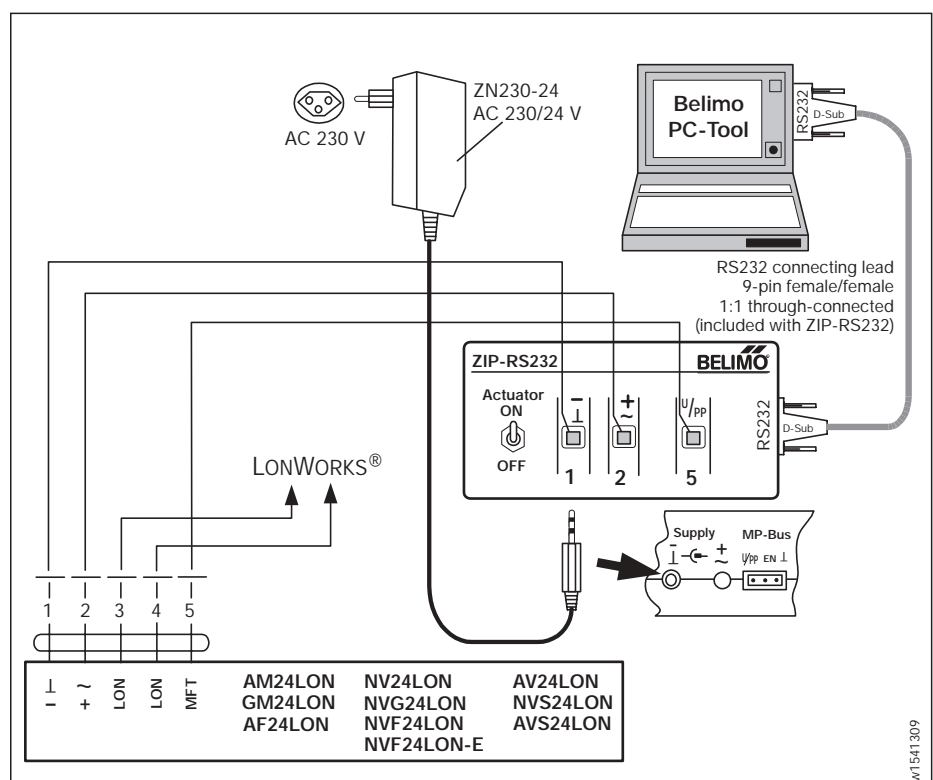

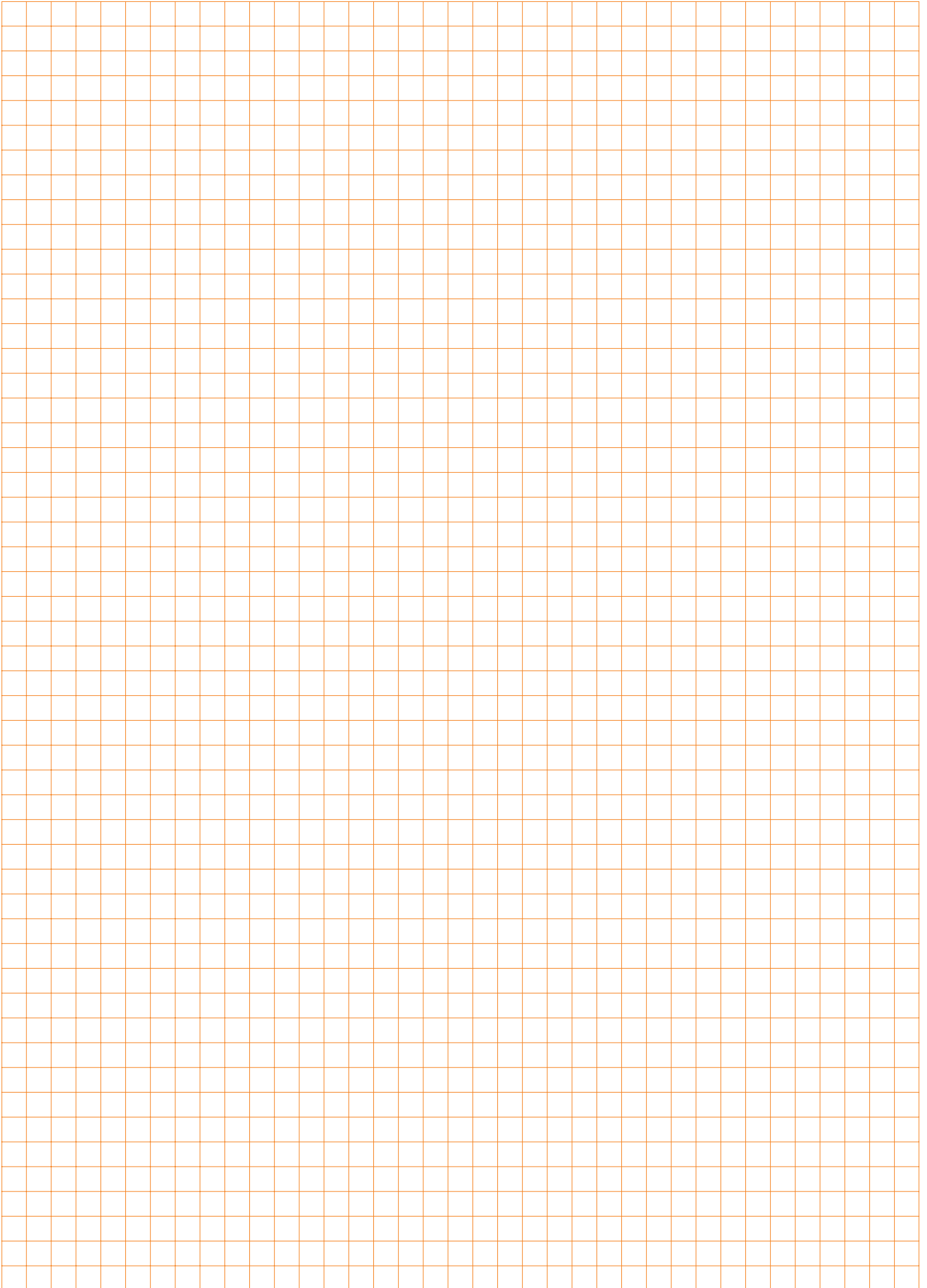

Innovation, Quality and Consultancy: A partnership for motorizing HVAC actuators

Air applications



Standard actuators and spring-return actuators for air control dampers in HVAC systems



Safety actuators for motorizing fire and smoke extraction dampers



VAV systems for individual room air control

Water applications



Mixing actuators and motorized ball valves for HVAC water circuits



Globe valves and intelligent linear actuators – also for leading makes of valve

Contact the following for further information:

Belimo Headquarters

CH BELIMO Holding AG
Brunnenbachstrasse 1
8340 Hinwil, Switzerland
Tel. +41 (0)43 843 61 11
Fax +41 (0)43 843 62 68
info@belimo.ch
www.belimo.ch

Belimo Subsidiaries

AT/ BELIMO Automation
HR/ Handelsgesellschaft m.b.H.
HU/ Geiselbergstrasse 26-32
SI/ 1110 Wien, Austria
SK Tel. +43 (0)1 749 03 61-0
Fax +43 (0)1 749 03 61-99
info@belimo.at

AU BELIMO Actuators Pty. Ltd.
Unit 10, 266 Osborne Avenue
Clayton South, VIC 3169
Australia
Tel. +61 (0)3 9551 0201
Fax +61 (0)3 9551 0215
belimo@belimoactuators.com

CA BELIMO Aircontrols (CAN), Inc.
5716 Coopers Ave., Units 14&15
Mississauga, Ontario L4Z 2E8
Canada
Tel. +1 (1)905 712 31 18
Fax +1 (1)905 712 31 24
webmaster@belimo.com

CH BELIMO Automation AG
Sales Switzerland
Brunnenbachstrasse 1
8340 Hinwil, Switzerland
Tel. +41 (0)43 843 62 12
Fax +41 (0)43 843 62 66
info@belimo.ch
www.belimo.ch

DE BELIMO Stellantriebe
Vertriebs GmbH
Welfenstr. 27, Postfach 72 02 30
70599 Stuttgart, Germany
Tel. +49 (0)711 1 67 83-0
Fax +49 (0)711 1 67 83-73
info@belimo.de
www.belimo.de

ES BELIMO Iberica
de Servomotores, S.A.
C/San Romualdo, 12-14
28037 Madrid, Spain
Tel. +34 91 304 11 11
Fax +34 91 327 25 39
info@belimo.es

FR BELIMO Servomoteurs
Z.A. de Courtry
33, Rue de la Régale
77181 Courtry, France
Tel. +33 (0)1 64 72 83 70
Fax +33 (0)1 64 72 94 09
mail@belimo.fr

GB BELIMO Automation UK Limited
The Lion Centre
Hampton Road West
Feltham, Middlesex, Great Britain
TW 13 6DS
Tel. +44 (0)20 8755 4411
Fax +44 (0)20 8755 4042
belimo@belimo.co.uk

HK BELIMO Actuators Ltd.
Room 208, 2/F
New Commerce Centre
19 On Sum Street, Shatin, N.T.
Hong Kong
Tel. +852 26 87 17 16
Fax +852 26 87 17 95
info@belimo.com.hk

PL BELIMO Słowniki S.A.
ul. Zagadki 21
02-227 Warszawa, Poland
Tel. +48 (0)22 886 53 05
Fax +48 (0)22 886 53 08
info@belimo.pl

SG BELIMO Actuators Pte Ltd
2, Jurong East Street 21
#04-31F IMM Building
Singapore 609601
Tel. +65 6564 9828
Fax +65 6564 9038
info@belimo.com.sg

US BELIMO Aircontrols (USA), Inc.
43 Old Ridgebury Road
P.O. Box 2928
Danbury, CT 06810 USA
Tel. +1 (1)203 791 99 15
Fax +1 (1)203 792 29 67
webmaster@belimo.com
www.belimo.com

Belimo Representatives and Agencies

AE BELIMO Trading
Middle East Office
P.O. Box 73885
Dubai, U.A.E.
Tel. +971 (0)4 295 9670
Fax +971 (0)4 295 9680
belimome@emirates.net.ae

BG BELIMO Bulgaria Ltd.
j.k. Lagera, 3 Smolyanska Str.
bl. 56, entr. B. ap. 50
1612 Sofia, Bulgaria
Tel. +3592 952 3470/1
Fax +3592 545 995
belimo@intech.bg

CN BELIMO Actuators Ltd.
Room 1305, Financial Square
No. 333 Jiujiang Road
200001 Shanghai, China
Tel. +86 21 6360 8980
Fax +86 21 6360 8981
shanghai@belimo.ch

CN BELIMO Beijing
Rm 605, Beijing Hai Chang
Edifice, 44, Liang Ma Qiao Road
Chao Yang District
100016 Beijing, China
Tel. +86 10 6462 1382
Fax +86 10 6462 1383
beijing@belimo.ch

CY R.E.S. Ltd.
P.O. Box 8297
Nicosia, Cyprus
Tel. +357 (0)2 51 10 07
Fax +357 (0)2 49 65 47
reliance@spidernet.com.cy

CZ BELIMO CZ (Ing. Ivar Mentzl)
Charvovská 16
10100 Praha 10, Czech Republic
Tel. +420 (0)2 717 40 311
Fax +420 (0)2 717 43 057
info@belimo.cz

DK BELIMO A/S
Thomas Helstedsvvej 7A
8660 Skanderborg, Denmark
Tel. +45 86 52 44 00
Fax +45 86 52 44 88
info@belimo.dk

EE BELIMO Balticum AS
Turi 10 d
11313 Tallinn, Estonia
Tel. +372 6 140 811
Fax +372 6 140 812
info@belimo.ee

FI Oy Suomen BELIMO Ab
Insinöörinkatu 2
00810 Helsinki, Finland
Tel. +358 (0)424 651 1
Fax +358 (0)424 651 250
belimo@belimo.fi

GR BELIMO Air Controls
29, Tagm, Plessa, Kalithea
GR 17674 Athens, Greece
Tel. +30 2 10 94 00 766
Fax +30 2 10 94 00 767
belimogr@tee.gr

IE Safegard Systems Ltd.
Systems House, Unit 34
Southern Cross Business Park
Bray, Co Wicklow, Ireland
Tel. +353 (0)1 2761600
Fax +353 (0)1 2761611
info@safegard.ie

IL Shemer Representations
P.O. Box 296
56101 Yehud, Israel
Tel. +972 3 536 51 67
Fax +972 3 536 05 81
shemer@shemerrep.co.il

IN BELIMO Vitek Air Controls
C-114 Lancelot, First Floor
S.V. Road, Borivali (West)
Mumbai 400 092, India
Tel. +91 22 5695 9439
Fax +91 22 2806 2163
bvac@bom2.vsnl.net.in

IS Hitataekni ehf.
Langholtsveg 109
104 Reykjavik, Iceland
Tel. +354 5 88 60 70
Fax +354 5 88 60 71
fridmar@hitataekni.is

IT BELIMO Servomotori S.r.l.
Via Stezzano, 5
24050 Zanica BG, Italy
Tel. +39 035 67 26 82
Fax +39 035 67 02 00
info@belimo.it

KR HANMO Corporation
3rd Floor, Yeosam Bldg. 648-23
Gangnam-Ku, Seoul, Korea
Tel. +822 3453 8225
Fax +822 3453 8228

LB Energy Center (EC)
Hamra, Leon Street, Shatilla,
Bldg. 4th Floor,
P.O. Box 113-6955
Beirut, Lebanon
Tel. +961 (0)1 35 38 23
Fax +961 (0)1 35 38 23
belimome@emirates.net.ae

NL/ BELIMO Servomotoren BV
BE/ BENELUX
LU Postbus 300, 8160 AH Epe
Radeweg 25, 8171 MD Vaassen
Netherlands
Tel. +31 5 78 57 68 36
Fax +31 5 78 57 69 15
info@belimo.nl

NO BELIMO Spjeldmotorer A/S
Konowsgate 5
0192 Oslo 1, Norway
Tel. +47 22 70 71 71
Fax +47 22 70 71 70
info@belimo.no

PH BELIMO Actuators Philippines
Rm.# 507 Anita Build., 5th Floor
1300 Quezon Ave., Cor.South Ave.
1103 Quezon City, Philippines
Tel. +63 (2)373 5440
Fax +63 (2)373 5424
philippines@belimo.com.hk

RO SC Mano Construct srl
Str. Cameliel nr 5, sector 1
Bucuresti, Romania
Tel. +40 212 126 993
Fax +40 212 126 995
manoconstruct@fx.ro

RU BELIMO Servomotors
Russia Ltd.
Nizhnyaya Pervomaiskaya,
46 Bld. 1, Office 303
105203 Moscow, Russia
Tel. +7 095 965 74 64
Fax +7 095 965 74 73
info@belimo.ru

SE BELIMO AB
Hägerstens Allé 88
129 37 Hägersten, Sweden
Tel. +46 (0)8 88 07 00
Fax +46 (0)8 97 85 75
info@belimo.se

SY Philippe A. Jebran
P.O. Box 7791
Damascus, Syria
Tel. +963 11 231 6586
Fax +963 11 231 4052
belimome@emirates.net.ae

TR BELIMO Otomasyon A.S.
Keyap Sitesi No. 20
TR-34775 Y. Dudullu
Istanbul, Turkey
Tel. +90 (0)216 527 98 70
Fax +90 (0)216 527 98 71
info@belimo.com.tr

TW Chianseng Enterprise Co., Ltd.
2F, No. 21, Tong Fong Street
Taipei, Taiwan
Tel. +886 2 27 08 77 80
Fax +886 2 27 02 90 90
taiwan@belimo.com.hk

UA BELIMO Ukraine S.A.R.
34-A, Ul. Yurkovskaya, Appt.N°2
254080 Kiev, Ukraine
Tel./Fax +380 44 463 7586
comaster@belimo.kiev.ua

ZA BELIMO Actuators Southern Africa cc
P.O. Box 2483
Alberton 1450, South Africa
Tel. +27 (0)11 868 5681
Fax +27 (0)11 900 2673
belimo@mega.co.za