

Convenient solutions

Table of contents

Product range overview: air volume and line pressure control	2
Technical data sheet	
Brief description	3
Overview of types	3
Technical data	4
Connection	5
VAV – Variable operation $\dot{V}_{min} \dots \dot{V}_{max}$	5
CAV – Step mode CLOSED / \dot{V}_{min} / \dot{V}_{mid} / \dot{V}_{max} / OPEN	6
MP-Bus operation – VAV / CAV operation	7
Sizing of feed and connection cables	7
Tool connection	8
Compatibility	9
Safety notes	9
Dimensions [mm]	10
Functions	
Table of contents	11
Conventional applications	
Table of contents	27
MP-Bus integration	
Table of contents	33
Functional check	
Table of contents	43

Product range overview: air volume and line pressure control

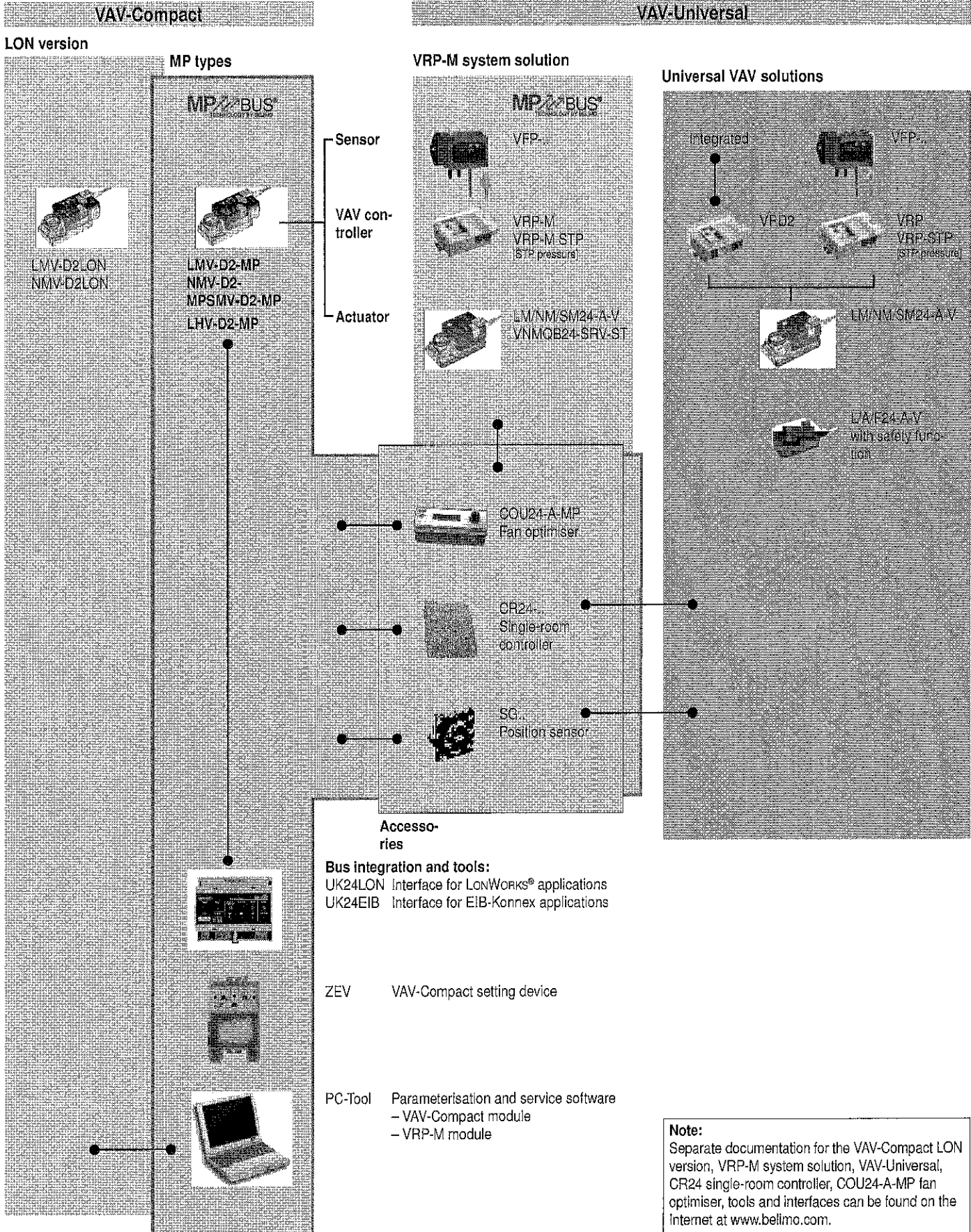

Allt i ett: Differenstryckgivare, digital VAV-regulator och spjällställdon som ger en kompakt totalfunktion med tryckberoende flödesstyrning i varje zon och möjlighet att ansluta till nätverk

Reglerfunktion: VAV-CAV / Open-Loop

Control:

DC 2...10 V / 0...10 V / MP-bus

Integration till

- DUC / regulator med MP-bus
- LONWORKS®
- EIB-Konnex
- Belimo fläktoptimer

Möjlighet att ansluta passiv eller aktiv givare lokalt. Värderna presenteras digitalt i nätverket. Kombinerad tryckknapp och LEDs för service och idriftsättning.

RJ-anslutning för service- och diagnosverktyg

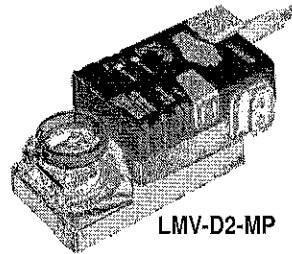

LMV-D2-MP

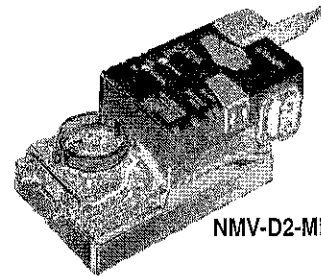

NMV-D2-MP

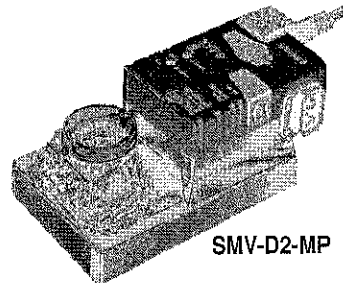

SMV-D2-MP

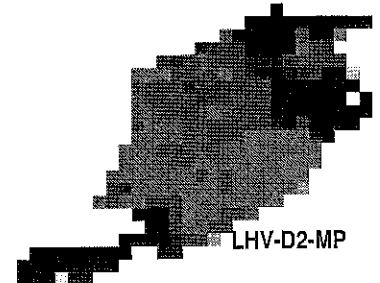

LHV-D2-MP

Produkt- och funktionsoversikt

Application	The digital VAV-Compact has PI control characteristics and is used for pressure-independent control of VAV units in the comfort zone.
Pressure measurement	Maintenance-free, dynamic, differential pressure sensor technology, proven in a wide range of applications, suitable for use in offices, hospital wards, alpine hotels or cruise liners.
Actuator	Three versions available, depending on the size of the VAV unit: 5 / 10 / 20 Nm. – Rotary actuator, depending on size – Linear actuator 150 N with 100, 200 or 300 mm linear motions
Control function	VAV-CAV or open-loop operation (actuator/ volumetric flow sensor) for integration in an external VAV control circuit. Feedback of damper position for fan optimisation
VAV – variable air volume	For variable air volume applications based on a modulating reference variable, e.g. supplied by a room temperature controller or a DDC or bus system. It facilitates demand-related, power-saving ventilation in individual rooms or in zones of air conditioning systems. The \dot{V}_{min} ... \dot{V}_{max} working range can be subdivided by selecting a mode. The following operating modes are available: DC 2...10 V / 0...10 V / adjustable / bus.
CAV – constant air volume	For constant air volume applications, e.g. in step mode, controlled by means of a switch. The following operating modes are available: CLOSE / \dot{V}_{min} / \dot{V}_{mid} / \dot{V}_{max} / OPEN
Bus function	Up to eight Belimo MP devices (VAV / damper actuator / valve) can be connected together over the MP-Bus and integrated into the following systems: – LONWORKS® applications with Belimo UK24LON interface – EIB Konnex applications with Belimo UK24EIB interface – DDC controller with integrated MP-Bus protocol – Fan optimiser applications with optimisation COU24-A-MP A sensor (0...10 V or passive, e.g. a temperature sensor) or a switch can optionally be integrated into the higher-level DDC or bus system via the MP-Bus.
Test function / test display	The VAV-Compact features an LED with a ready display for commissioning and functional checking as well as a service mode with air shortage, excess air and setpoint = actual value display with LEDs.
Operating and service devices	Belimo PC-Tool, remote control or ZEV, plugged into the VAV-Compact oder via MP-Bus
Assembly and connection	The VAV-Compact, which is assembled on the unit by the OEM, is connected using the prefabricated connecting cable.
OEM factory settings	The VAV-Compact is mounted on the VAV unit by the unit manufacturer, who adjusts and tests it according to the application. The VAV-Compact is sold exclusively via the OEM channel for this reason.

Overview of types

Type	Torque	Power consumption	For wire sizing	Weight
LMV-D2-MP	5 Nm	3 W	5 VA (max. 5 A @ 5 ms)	approx. 500 g
NMV-D2-MP	10 Nm	3.5 W	5.5 VA (max. 5 A @ 5 ms)	approx. 700 g
SMV-D2-MP	20 Nm	4 W	6 VA (max. 5 A @ 5 ms)	approx. 830 g
LHV-D2-MP	150 N	3.5 W	5.5 VA (max. 5 A @ 5 ms)	approx. 550 g

Technical data

Supply	
Nominal voltage	AC 24 V, 50/60 Hz DC 24 V
Power supply range	AC 19.2 ... 28.8 V DC 21.6 ... 28.8 V
Differential pressure sensor	
	2 ... ~300 Pa (OEM-specific)
Operating pressure	max. 1000 Pa
Characterising	OEM-specific differential pressure sensor, linearisation
Installation position	Any, no reset necessary
Operating medium (see «Materials»)	Supply and exhaust air in the comfort zone and in applications with sensor-compatible media
Materials	PC + ABS to UL94-V0; stainless steel, DIN 1.4301 X10CrNiS1810; PP Santoprene
Measuring air conditions	0 ... +50°C / 5 ... 95% r.h., non-condensing
Control function	
	– VAV-CAV – Open-loop operation
VAV and CAV applications	
	– Supply/exhaust air units in stand-alone operation / master-slave / parallel connection for rooms with positive/negative pressure or neutral air pressure – Mixing units
Operating volumetric flow	
\dot{V}_{nom}	OEM-specific nominal volumetric flow setting, matches VAV box
\dot{V}_{max}	30 ... 100% of \dot{V}_{nom}
\dot{V}_{min}	0 ... 100% of \dot{V}_{nom} (see VAV-Compact documentation, page 17 «Minimum setting limit»)
\dot{V}_{mid}	0 ... 100% of (\dot{V}_{min} ... \dot{V}_{max})
Classic control	
Mode for reference value input w (connection 3)	– DC 2 ... 10 V / (4 ... 20 mA with 500 Ω resistance) – DC 0 ... 10 V / (0 ... 20 mA with 500 Ω resistance) – Adjustable DC 0 ... 10
Mode for actual value signal U5 (connection 5).	– DC 2 ... 10 V – DC 0 ... 10 V – Adjustable: Air volume or damper position
	} Input resistance min. 100 kOhm } max. 0.5 mA
Operating modes for constant air volume	CLOSE / \dot{V}_{min} / \dot{V}_{mid} * / \dot{V}_{max} / OPEN * (* only with AC 24 V supply)
MP-Bus function	
Address in bus operation	MP 1 ... 8 (classic control: PP)
LONWORKS® / EIB-Konnex	With BELIMO UK24LON / UK24EIB interface, 1 ... 8 BELIMO MP devices (VAV / damper actuator / valve)
DDC controller	DDC controller / PLC, from various manufacturers, with integrated MP interface
Fan optimiser	With BELIMO optimiser COU24-A-MP
Sensor integration	Passive (Pt1000, Ni1000 etc.) and active sensors (0...10 V) e.g. temperature, humidity 2-point signal (switching capacity 16 mA @ 24 V), e.g. switches, occupancy switches
Operation and servicing	
Communication	Pluggable / PC-Tool (V3.1 or higher) / ZEV hand-operated device
Button	PP/MP-Bus, max. DC 15 V, 1200 baud
LED indicator	Adaptation / addressing / service function
	– 24 V feed – Status / service / bus function
Actuator	
	Brushless, non-blocking actuator with current reduction
Direction of rotation	ccw / cw or ↑ / ↓
Adaptation	Setting range recording and resolution to control range
Manual disengagement	Pushbutton, self-resetting without affecting functions
Sound power level	max. 35 dB (A), SMV-D2-MP max. 45 dB (A)
Actuator – full-rotation	
Angle of rotation	95° ↺, with adjustable mechanical or electronic limiting
Position Indication	Mechanical with pointer
Spindle driver	– Clamp, for round spindles 10 ... 20 mm / square spindles 8 ... 16 mm – Positive fit, wide range of versions, e.g. 8 x 8 mm
Actuator – linear	
Stroke	100, 200 or 300 mm, with adjustable mechanical or electronic limiting
Connection	
	Cable, 4 x 0.75 mm ² , terminals
Safety	
Protection class	III Safety extra-low voltage
Degree of protection	IP54
EMC	CE according to 89/336/EEC

Technical data (continued)

Safety

Mode of operation	Type 1 (to EN 60730-1)
Rated impulse voltage	0.5 kV (to EN 60730-1)
Control pollution degree	2 (to EN 60730-1)
Ambient conditions	0 ... +50°C
Non-operating temperature	-20 ... +80°C
Ambient humidity range	5 ... 95% rH, non-condensating (to EN 60730-1)
Maintenance	Maintenance-free

Connection

Connecting cable The connection is established via the connection cable installed on the VAV-Compact device.

Note

- Supply via safety isolation transformer!
- Connections 1, 2 (AC/DC 24 V) and 5 (MP signal) must be routed to accessible terminals (room temperature controller, floor distributor, control cabinet, etc.), in order to simplify access with the PC-Tool for diagnostic and service work.

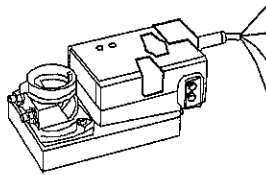

No	Designation	Wire colour	Function
1	BK COM	black	Supply AC/DC 24 V
2	RD + ~	red	
3	WH Y	white	Reference signal VAV / CAV
5	OG U	orange	- Actual value signal - MP-Bus connection

VAV – Variable operation $V_{min} \dots V_{max}$

Wiring diagrams

Example 1:
VAV with analogue reference signal

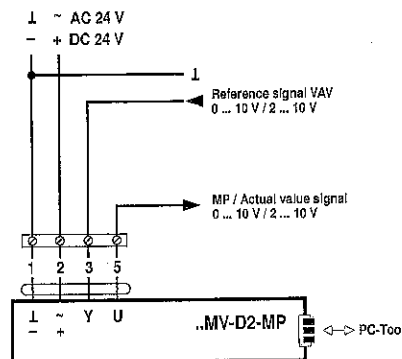

Example 2:
VAV with shut-off (CLOSE), 2...10 V mode

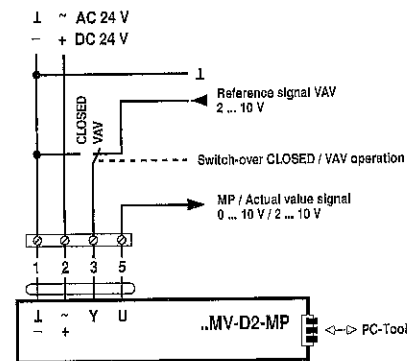

Example 3:
VAV parallel operation with analogue reference signal Supply/exhaust air

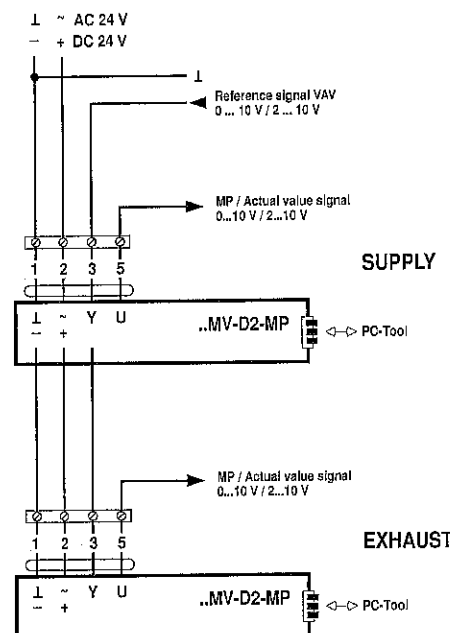

Example 4:
VAV master-slave operation with analogue reference signal

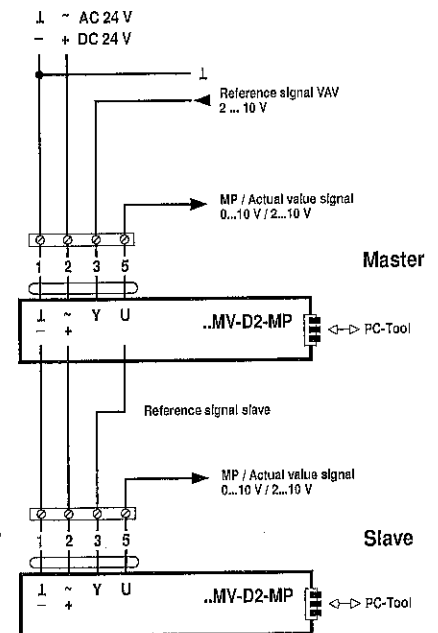

CAV – Step mode CLOSED / \dot{V}_{min} / \dot{V}_{mid} / \dot{V}_{max} / OPEN

CAV control

- Two options are available for CAV control:
 - Standard: CLOSED – \dot{V}_{min} – \dot{V}_{max} – OPEN (default setting)
 - NMV-D2M-compatible CLOSED – \dot{V}_{min} – \dot{V}_{mid} – \dot{V}_{max} – OPEN
- The setting can be changed with the PC-Tool from Version V3.1

Wiring diagrams

Note
The contacts are mutually interlocking!

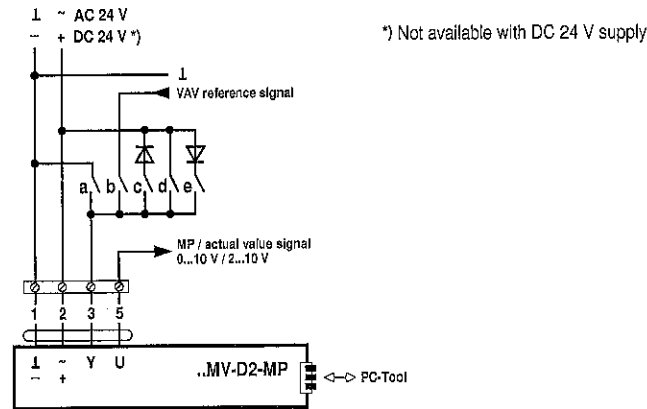

CAV function: Standard

Mode setting	2...10 V	0...10 V	0...10 V	0...10 V	0...10 V
Signal	1 -	0...10 V 2...10 V	~	~	~
Function	3	3	3	3	3
Damper CLOSED	a) CLOSED		c) CLOSED*		
$\dot{V}_{min} \dots \dot{V}_{max}$		b) VAV			
CAV – \dot{V}_{min}	All open – \dot{V}_{min} active				
Damper OPEN				e) OPEN*	
CAV – \dot{V}_{max}			d) \dot{V}_{max}		

Legend

 * Not available with DC 24 V supply

Example:

CAV application: CLOSED – \dot{V}_{min} – \dot{V}_{max} (2...10 V mode)

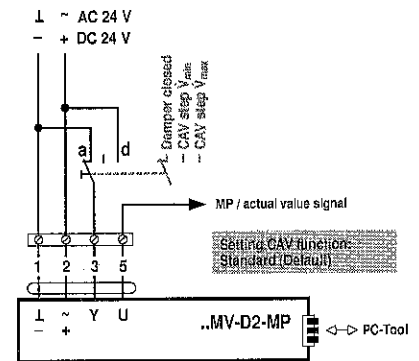

Note
You must set the CAV function to NMV-D2M-compatible in order to use the CAV \dot{V}_{mid} step.

CAV function: NMV-D2M-compatible

Mode setting	2...10 V	0...10 V	0...10 V	0...10 V	0...10 V
Signal	1 -	0...10 V 2...10 V	~	~	~
Function	3	3	3	3	3
Damper CLOSED	a) CLOSED				
$\dot{V}_{min} \dots \dot{V}_{max}$		b) VAV			
CAV – \dot{V}_{min}	All open – \dot{V}_{min} active				
Damper OPEN				e) OPEN*	
CAV – \dot{V}_{max}			d) \dot{V}_{max}		
CAV – \dot{V}_{mid}			c) \dot{V}_{mid} *		

Legend

 * Not available with DC 24 V supply

Example:

CAV application: \dot{V}_{min} – \dot{V}_{mid} – \dot{V}_{max} (0...10 or 2...10 V mode)

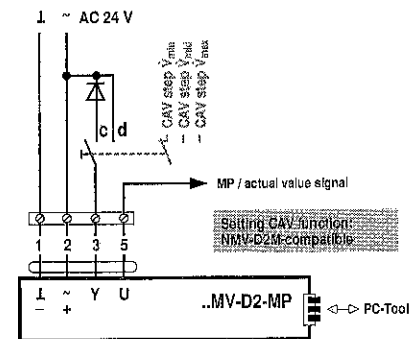

Note
 – Supply via safety isolation transformer!
 – Connections 1, 2 (AC/DC 24 V) and 5 (MP signal) must be routed to accessible terminals (room temperature controller, floor distributor, control cabinet, etc.), in order to simplify access with the PC-Tool for diagnostic and service work.

MP-Bus operation – VAV- / CAV operation

Connecting cable

The connection to the MP-Bus is established via the connection cable installed in the VAV-Compact device.

Note

- Supply via safety isolation transformer!
- Connections 1, 2 (AC/DC 24 V) and 5 (MP signal) must be routed to accessible terminals (room temperature controller, floor distributor, control cabinet, etc.), in order to simplify access with the PC-Tool for diagnostic and service work.

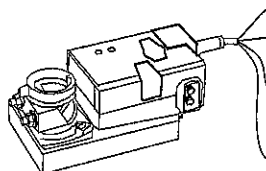

No	Designation	Wire colour	Function
1	BK COM \perp	black	} Supply AC/DC 24 V
2	RD + ~	red	
3	WH Y	white	Input for – Sensor linking – Override control
5	OG U	orange	MP-Bus connection

Wiring diagrams

Bus operation – VAV function

For detailed information, see section «MP-Bus integration»

Bus operation – VAV function with integrated switch

For detailed information on sensor integration, see section «MP-Bus integration»

Note

- For further information about the connection, override controls, MP-Bus cables, etc., see section «MP-Bus integration»
- This is a connection description. Depending on the application, the terminal allocation may vary. The connection and commissioning must be carried out by trained personnel.

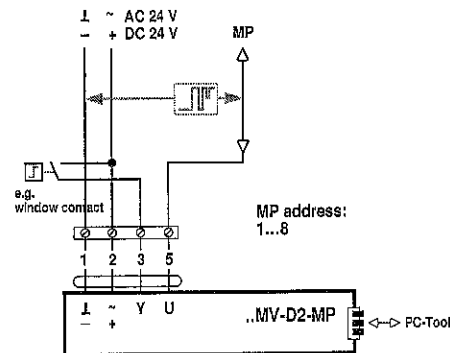
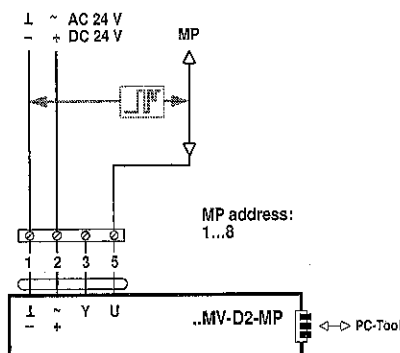

Sizing of feed and connection cables

General

In addition to the actual wire sizing, attention must also be paid to the surrounding area and the cable routing. Signal cables must not be laid in the vicinity of load cables, objects liable to cause EMC interference etc. if possible. Paired or layer stranded cables improve immunity to interference.

24 V feed, sizing and wiring

The wire sizing and installation of the AC 24 V supply, the fuse protection, and the cables are dependent on the total operated load and local regulations. Account must be taken of the following performance data, including starting currents of the actuators:

- Sizing values VAV-Compact controller, see Techn. Data
- Sizing values of further controlling elements etc. can be found in the current data sheets and product information
- Other devices which are intended to be connected to the same 24 V feed
- Reserve capacity for subsequent expansion, if planned.

MP-Bus integration – supply, Sizing and wiring

See MP-Bus integration, page 33 ... 42.

Tool connection

Setting and diagnostics

Setting and the diagnostics of the connected VAV-Compact controller can – thanks to the MP-Bus technology – be checked and set quickly and easily with the Belimo PC-Tool or the ZEV hand-operated device.

On-board service connection

The service connection integrated in the VAV-Compact allows the console used to be connected quickly.

Belimo VAV operating and service devices

- ZEV hand-operated device with integrated level converter
- Belimo PC-Tool, with level converter ZIP-232-KA

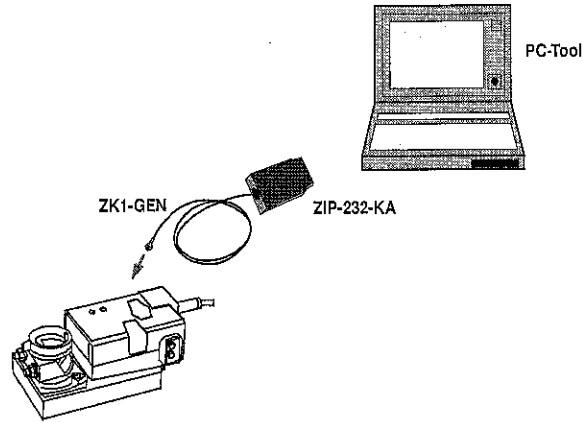

Note

In principle, it is possible to use the ZEV setting device.
For limitations, see «Compatibility» (www.belimo.com).

MP connection (5)

Belimo VAV operating and service devices

- ZEV hand-operated device with integrated level converter
- Belimo PC-Tool, with level converter ZIP-232-KA or ZIP-RS232

The VAV-Compact can also communicate (connection wire 5) with the available service tools via the MP connection. The connection can be established during operation on site, i.e. in the connection socket of the Belimo room temperature controller CR24 or on the floor or control cabinet terminals.

If needed, the VAV-Compact can be fed via the 24 V of the level converter ZIP-RS232.

Feed via ZIP-RS232

Connection in running system

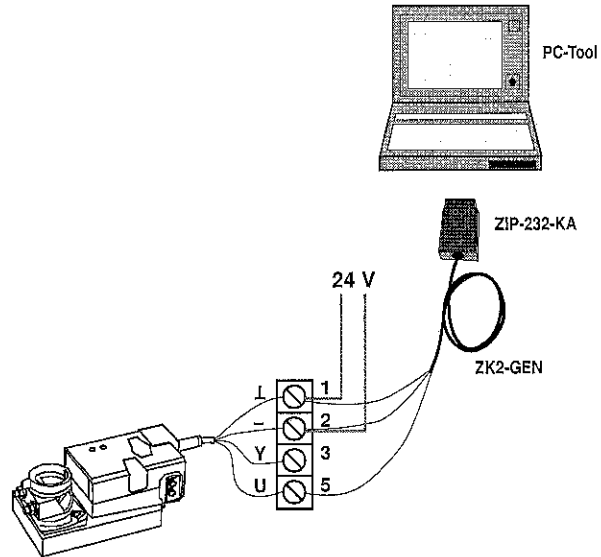
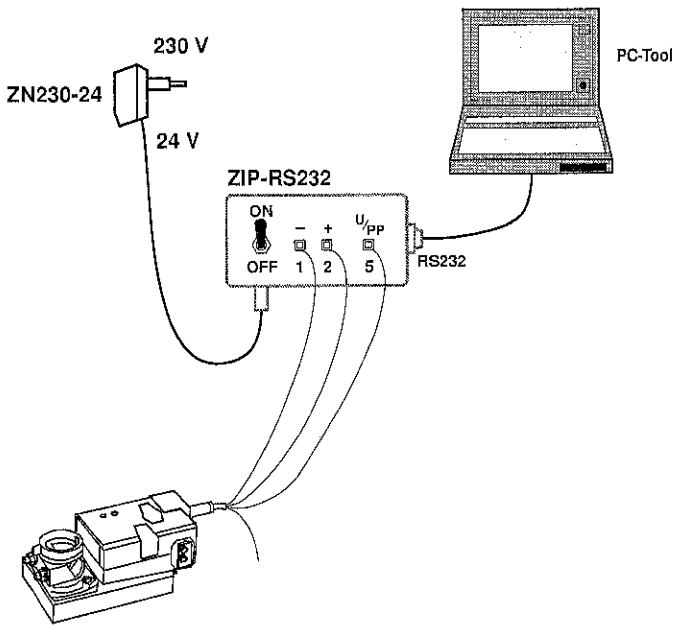

Dimensions [mm]

Dimensional drawings LMV-D2-MP

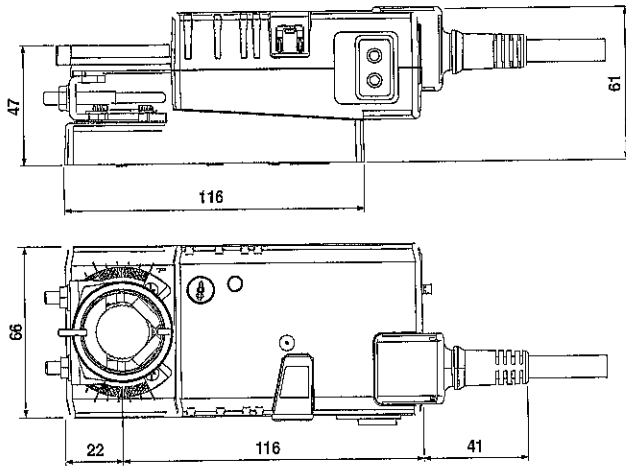

Dimensional drawings NMV-D2-MP

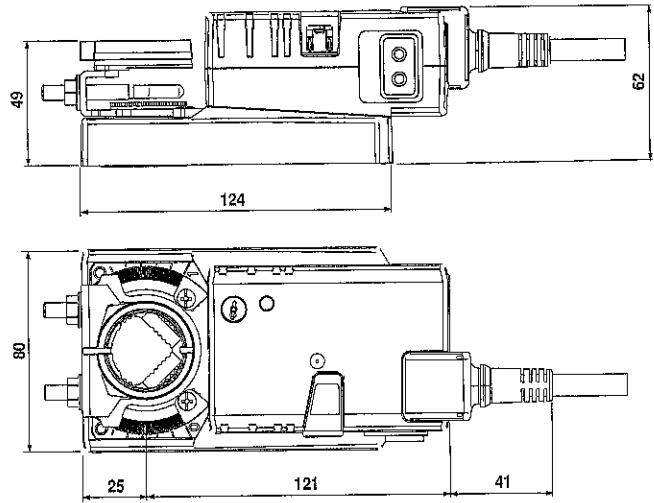

Dimensional drawings SMV-D2-MP

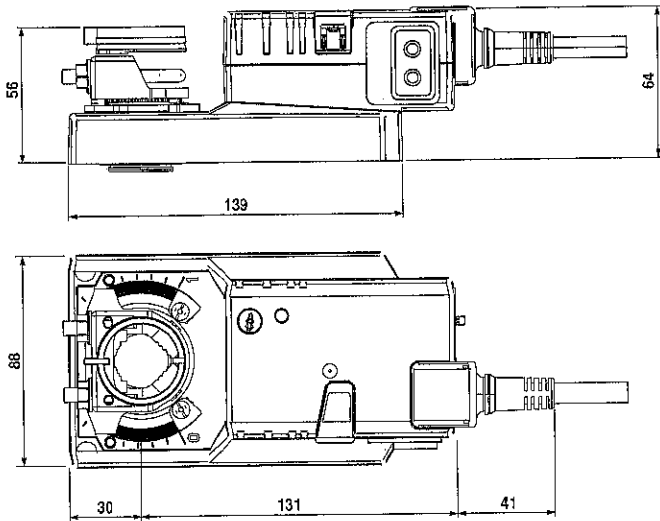

Dimensional drawings LHV-D2-MP

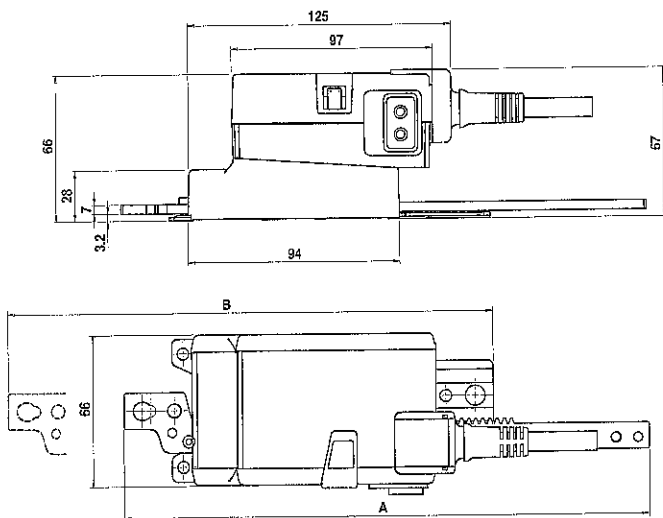
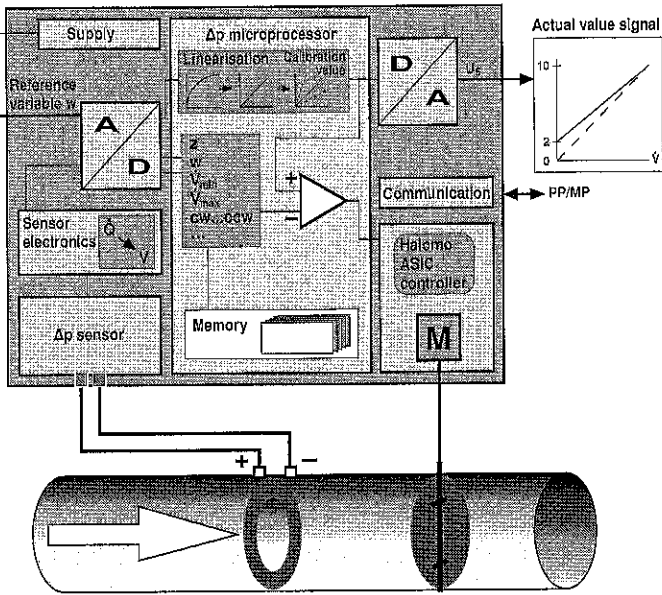

Table of contents

Volumetric flow measurement / setting	
Principle of operation of the VAV-Compact	2
Volumetric flow measurement	2
Nominal volumetric flow \dot{V}_{nom}	3
Operating volumetric flow setting $\dot{V}_{min} / \dot{V}_{mid} / \dot{V}_{max}$	3
Reference signal Y	4
Actual value signal U_s	
Actual value signal U_s – volumetric flow	5
Actual value signal U_s – damper position	5
Actual value signal U_s – setting	6
Actual value signal U_s – volumetric flow determination based on voltage level	6
Mode determination with U_s signal	6
Control functions	
Minimum setting limit	7
Creep flow suppression	7
CAV / VAV and open loop control functions	7
Master/slave connection	10
Parallel connection	11
Operation	12
LED function table	13
Settings	14
Operating and fault messages	15

Volumetric flow measurement / setting

Principle of operation of the VAV-Compact



Block diagram

The non-linear differential pressure signal is converted by the sensor in the measurement section (sensor electronics, linearisation) to a linear signal that is proportional to the volumetric flow. The reference signal w is conditioned as a setpoint signal according to the operating volumetric flow setting $\dot{V}_{min} / \dot{V}_{max}$.

The current system deviation acts as the control signal for the integrated actuator. The current volumetric flow is made available as an actual value signal for indicating and controlling slave VAV controllers. In combination with a precise differential pressure sensor, the specially designed running time logic of the VAV-Compact guarantees high control quality for the VAV unit in which it is installed.

You can choose between control with a classic control signal or via the MP-Bus, depending on the application.

Volumetric flow measurement

The volumetric flow measurement is based on a differential pressure sensor, which is usually installed in the air duct in the form of a diaphragm, a Venturi nozzle or a measuring cross. Various measurement methods for detecting volumetric flow are meanwhile established.

Reliable and exact differential pressure measurement – the key to precise air volume control

The differential pressure measurement method adopted by Belimo permits reliable averaging measurements even under unfavourable inflow conditions.

Every sensor used to measure differential pressure has its own dynamic response. The influence of this measuring body on the volumetric flow calculation is referred to as the instrument constant «c». In reality, however, this constant is not as constant as its name suggests but rather dependent on the effective flow rate. Each differential pressure sensor exhibits more or less non-linear behaviour, depending on the physical characteristics of its particular design. Belimo calculates the response of the respective differential pressure sensor in multiple measurement series as the basis for customised VAV-Compact controllers. The recorded measurement curve is compensated in a linearisation process developed by Belimo specifically for this purpose. This process is referred to as characterising.

Features of the Belimo D2 differential pressure sensor

- Precise and proven thermoanemometric measurement principle, temperature-compensated.
- Wide measuring range, high degree of accuracy over the complete ~2...300 Pa range in combination with conventional, proprietary differential pressure sensors
- Also in the lower differential pressure range.
- No need to balance the zero during start-up or operation.
- Maintenance-free technology, proven in a wide range of applications.
- No condensation remains in the sensor, i.e. any installation position is possible.
- Measurement in any position, i.e. no special installation requirements.
- Insensitivity to contamination because the measuring element is located outside the air flow.

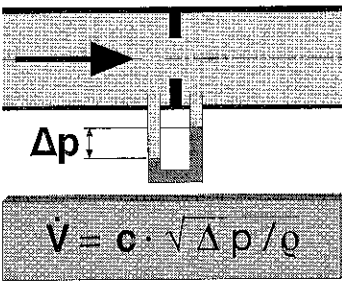

Legend:
 \dot{V} = Volumetric flow
 c = Geometry-related constant of the baffle device
 Δp = Differential pressure
 ρ = Medium density

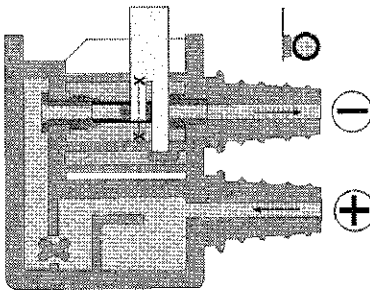

Sensor design
 Only three materials in contact with the air:
 - PC + ABS sensor housing acc. to UL94-V0
 - Chrome-nickel steel nozzle pipe
 - Santoprene tube holder

Flow medium
 0...+50°C / 5...95% rH, non-condensing

non-corrosive flow medium	slightly corrosive flow medium	Sea air (salty)	corrosive flow medium	dusty flow medium
good suitability	good suitability	good suitability	examine makeup and material compatibility	limited suitability
Check use with VAV-Universal				

Volumetric flow measurement / setting (continued)

Volumetric flow actual value signal U_s

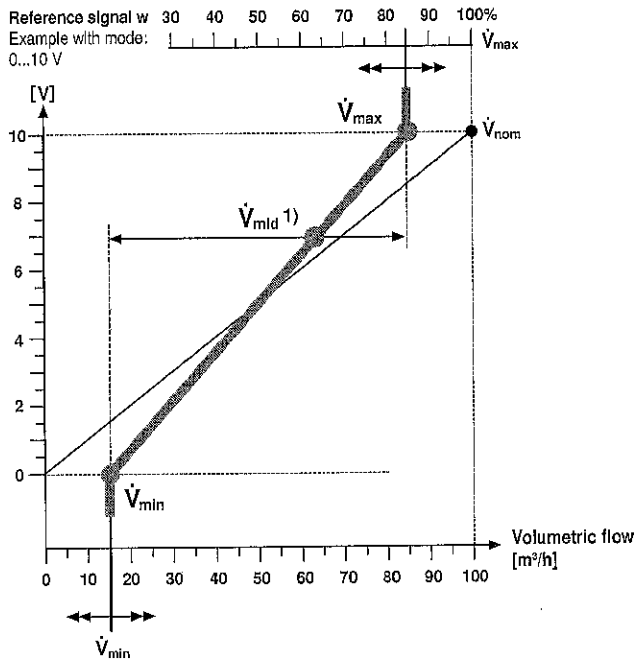
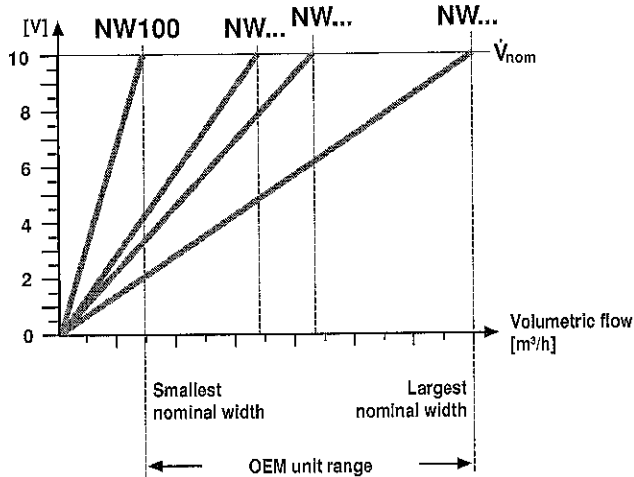

Nominal volumetric flow \dot{V}_{nom}

Energy and acoustic considerations mean that the specific volumetric flow for each duct diameter is not allowed to exceed a defined value. The binding nominal volumetric flow is fixed by the unit manufacturer, who is also responsible for the functionality of the VAV units. The nominal volumetric flow setting – also referred to as the calibration value – entails adapting the VAV-Compact to the installed VAV unit. The size, the nominal volumetric flow and the operating parameters are taken into account and set. \dot{V}_{nom} corresponds to the maximum volumetric flow of the VAV unit at which the pressure drop and noise are still within the permissible operating conditions.

The active calibration method used by Belimo, i.e. calibration with a reference volumetric flow, compensates any deviations due to mechanical tolerances in the manufacturing process. Since these values and the operating data of each VAV unit are unique, this process is carried out by the manufacturer when the unit is assembled in the factory. No subsequent settings are necessary on the system – helping to significantly reduce installation and commissioning time and costs.

Operating volumetric flow setting $\dot{V}_{min} / \dot{V}_{mid} / \dot{V}_{max}$

The linear characteristic curve of the air volume controller enables the operating volumetric flows on the system side to be set easily. This setting is usually carried out either by the unit manufacturer or when the system is commissioned. \dot{V}_{max} acts as the upper limit value as a function of the nominal volumetric flow. \dot{V}_{min} can be set as a percentage of the required \dot{V}_{nom} . An intermediate position \dot{V}_{mid} is available for constant air volume (CAV) applications to facilitate finer steps. ¹⁾

Function	Volumetric flow	Range
\dot{V}_{nom}	Nominal	OEM-specific value, depending on the VAV unit type and the application
\dot{V}_{max}	Maximum	30...100% of \dot{V}_{nom}
\dot{V}_{min}	Minimum	*0...100% of \dot{V}_{nom} (*OEM-specific)
$\dot{V}_{mid}^{1)}$	Intermediate position	0...100% in the range from \dot{V}_{min} to \dot{V}_{max}

* The minimum volumetric flow setting \dot{V}_{min} varies according to the type of VAV unit.

See «minimum setting limit» and «creep flow suppression» functions, page 17.

1) Requires CAV setting: NMV-D2M compatible, see page 6.

Volumetric flow measurement / setting (continued)

\dot{V}_{min} 0% setting

The actuator positively closes the damper if the minimum volumetric flow is set to 0% and the reference signal corresponds to the value.

Settings: Responsibility, tools

After the CAV / VAV unit has been manufactured, the operating volumetric flows \dot{V}_{min} / \dot{V}_{max} calculated by the system planning engineer are set in the factory. Various setting devices are available for checking and correcting these values on the system (see tools and settings).

OEM basic values

If the OEM settings have been corrected on the system, the basic values (\dot{V}_{min} , \dot{V}_{mid} , \dot{V}_{max}) can be restored using the OEM reset function.

Reference signal Y

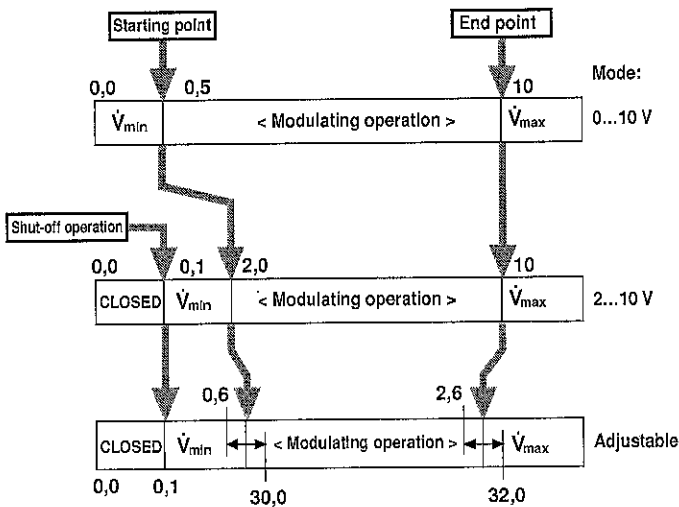

The reference signal Y is defined by the mode function. The following settings are available:

- 0...10 V
- 2...10 V
- Adjustable

Actual value signal U_5 **Note**

We recommend installing connection U_5 (actual value signal / MP connection) of each VAV controller in an accessible position, e.g.: room temperature controller (CR24-Bx), floor controller, control cabinet. This allows you to use setting and control functions without direct access to the VAV controller.

Example
with mode:
0...10 V

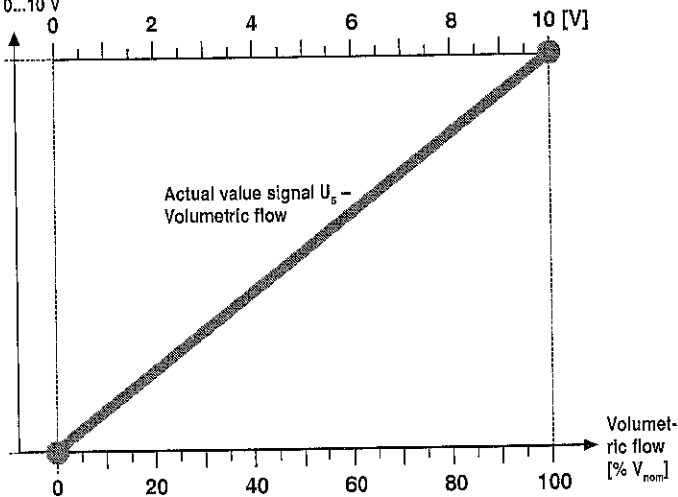

Example
with mode:
0...10 V

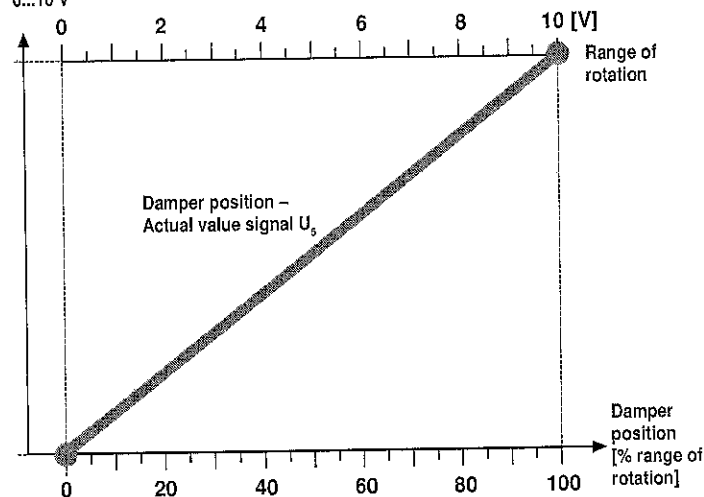
**Two measured variables**

The VAV-Compact supplies one of two measured variables as an actual value signal:

- Volumetric flow as 0...100% of \dot{V}_{nom} (default setting)
 - Damper position as 0...100% of the available angle of rotation
- The setting can be switched with PC-Tool (Version V3.1 or higher).

Actual value signal U_5 – volumetric flow

The volumetric flow actual value signal U_5 indicates the current volumetric flow measured with the differential pressure sensor of the VAV unit. This value corresponds to 0...100% of the set nominal volumetric flow. \dot{V}_{nom} is set in the factory by the unit manufacturer and indicated on the VAV unit nameplate.

The actual value signal U_5 – volumetric flow:

- Corresponds to 0...100% of \dot{V}_{nom}
- Indicates the current actual volumetric flow
- Is not influenced by the \dot{V}_{min} and \dot{V}_{max} settings
- Has a shape that can be influenced by the mode and/or variable settings
- Must not be interconnected with the U_5 signals of other VAV-Compact controllers in conventional operation

Application:

- Reference signal for the slave unit in master/slave applications
- Volumetric flow indication, e.g. display on BMS, totalising function

Actual value signal U_5 – damper position

The damper position actual value signal indicates the current damper position.

The value is shown as 0...100% of the adapted, i.e. available, damper setting range.

The actual value signal U_5 – damper position:

- Corresponds to 0...100% of the adapted damper range of rotation
- Indicates the current damper position
- Cannot be used to determine the current volumetric flow but is primarily a function of the prevailing system supply pressure
- Has a shape that can be influenced by the mode and/or variable settings
- Must not be interconnected with the U_5 signals of other VAV-Compact controllers in conventional operation

Application:

- Indication, e.g. display on BMS
- Evaluation of the damper position for analogue-controlled fan optimisation

Actual value signal U_5 (continued)

Actual value signal U_5 – setting

• Influence of the mode setting on the actual value signal U_5

The actual value signal U_5 is influenced by the set operating range. If the mode is set to 0...10 V, the display range of the U_5 signal is 0...10 V while if the mode is 2...10 V, the display range is 2...10 V.

• Adjustable actual value signal U_5

The U_5 signal can be adapted with the PC-Tool! U_5 feedback function for special applications; adjustable operating range:

- Starting point DC 0.0...8 V
- End point DC 2.0...10 V

Actual value signal U_5 – volumetric flow determination based on voltage level

The volumetric flow can be determined based on the actual value signal U_5 using a standard voltmeter. The two formulae below show how the voltage signal is converted to a volumetric flow:

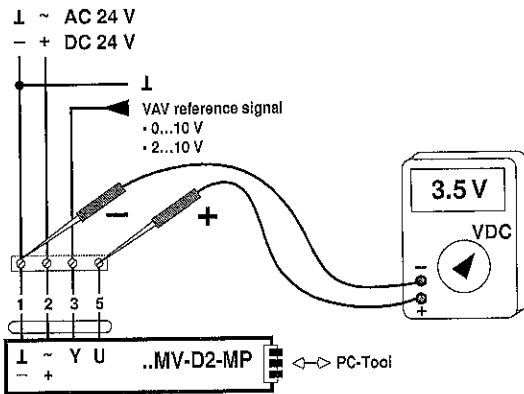

Example: 0...10 V

Find: Current volumetric flow

Voltage measured at U_5 : 3.5 V

\dot{V}_{nom} : 2500 m³/h

$$\frac{3.5 \cdot 2500}{10} = 875$$

The current volumetric flow is thus **875 m³/h**

Formula for 0...10 V mode: $\dot{V} = \frac{U_5 \cdot \dot{V}_{nom}}{10}$

Formula for 2...10 V mode: $\dot{V} = \frac{U_5 - 2,0}{8,0} \cdot \dot{V}_{nom}$

Example: 2...10 V

Find: Current volumetric flow

Voltage measured at U_5 : 6 V

\dot{V}_{nom} : 3300 m³/h

$$\frac{6.0 - 2.0}{8.0} \cdot 3300 = 1650$$

The current volumetric flow is thus **1650 m³/h**

Mode determination with the U_5 signal

If no tool is available, the mode can be determined with the U_5 signal and a voltmeter:

- a) Mark the +/- pressure hoses and disconnect them from the VAV-Compact.
- b) Allow the sensor to cool down for 2–3 minutes.
- c) Measure the U_5 signal.
- d) Connect the pressure hoses again.

Display	Mode
0 Volt	0...10 V
2 Volt	2...10 V
x Volt	variable setting

Note

If actual value signal U_5 is used to display the damper position, this method cannot be implemented.

Control functions

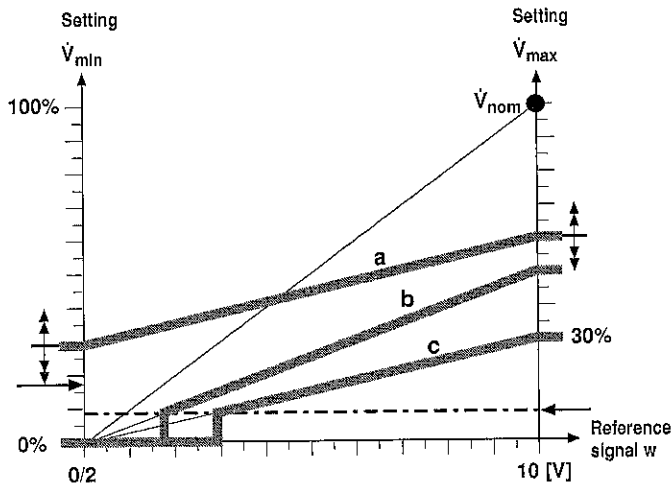

Legend:

- 1 Unit manufacturer's minimum setting limit
- 2 Creep flow suppression < 2 Pa
- a Setting without restriction
- b Setting with restriction
- c \dot{V}_{max} 30% setting = worst case, i.e. with the greatest restriction

Minimum setting limit (1) (unit-specific value)

Oversizing of the VAV units can make control more difficult in the lowest differential pressure range. A minimum volumetric flow, usually corresponding to a differential pressure of ~ 5 ... 12 Pa, is therefore specified for these units by the manufacturer. Functional restrictions in this range can be avoided by complying with the unit manufacturer's volumetric flow setting.

Creep flow suppression (2)

The creep flow suppression function suppresses differential pressure signals in the zero region. Undefined actuator movements in the pressure range below 2 Pa are prevented by this limitation. The operating range is physically limited owing to the dynamic behaviour of the differential pressure sensor, the flow pattern of the fluid being pumped and the response threshold of the sensor.

CAV / VAV and open loop control functions

The VAV-Compact can be operated with either of two control functions:

- CAV / VAV operation (default setting)
 - Open loop operation
- The setting can be switched with PC-Tool (Version V3.1 or higher).

CAV / VAV operation

This control function corresponds to the conventional CAV / VAV function.

- CAV (constant air volume) control in step mode CLOSED / \dot{V}_{min} / \dot{V}_{mid} / \dot{V}_{max} / OPEN.
- For step control acting on input terminal 3, see page 6.

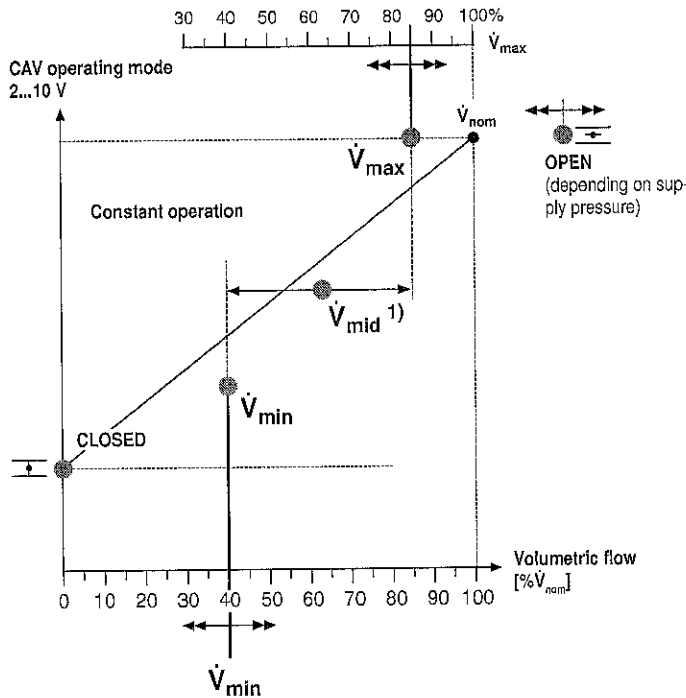

Application

Step-controlled CAV application, e.g.:

- Occupancy switch \dot{V}_{min} / \dot{V}_{max} or
- Conference room with veto button for flushing operation \dot{V}_{min} / \dot{V}_{max}

The VAV-Compact adjusts the volumetric flow to the fixed selected value in constant air volume applications. One or more operating modes can be specified as required.

The following operating modes are available:

CLOSED / \dot{V}_{min} / \dot{V}_{mid} / \dot{V}_{max} / OPEN

- Shut-off operation – damper CLOSED:
The damper is moved into the CLOSED position (0%) in a defined way.
- \dot{V}_{max} / \dot{V}_{mid} / \dot{V}_{min} operating modes:
The VAV-Compact adjusts the volumetric flow to the fixed selected value.
- Flushing operation – damper OPEN:
The damper can be opened (100%) for maximum ventilation, in which case air volume control is deactivated.

1) Requires CAV setting: NMV-D2M compatible, see page 6.

Control functions (continued)

VAV (variable air volume) controller $\dot{V}_{min} \dots \dot{V}_{max}$
 Corresponds to the VAV reference value input Y

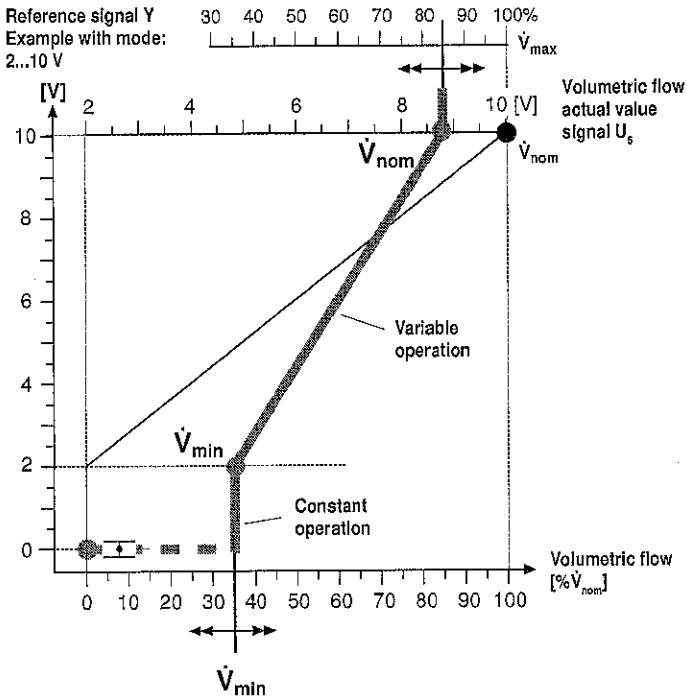

Application

Room temperature-controlled VAV application, e.g.:
 – Belimo CR24 room temperature controller, or
 – Third-party controller with 0...10 V output

VAV – reference signal Y

The reference signal Y allows the volumetric flow to be controlled linearly within the bandwidth of the set operating volumetric flows. This allows ventilation to be controlled according to demand, for example in a conference room where the volumetric flow increases continuously from the minimum setting (hygiene ventilation) up to the maximum value as a function of the room temperature.
 The output signal of a master controller or a setpoint generator is supplied to the reference value input of the VAV-Compact for this purpose. This signal controls the volumetric flow linearly in the set operating volumetric flow range.

The reference signal Y:

- Controls linearly in the $\dot{V}_{min} \dots \dot{V}_{max}$
- Is used to control the VAV-Compact in VAV and CAV applications
- Has a shape that can be influenced by the mode and/or variable settings

Variable air volume operation (VAV)

The required volumetric flow is specified linearly in the $\dot{V}_{min} \dots \dot{V}_{max}$ range by means of an analogue reference signal or via the MP-Bus.

Shut-off operation (CLOSED) with \dot{V}_{min} 0%

If a shut-off function is required in VAV operation, it can be achieved by setting \dot{V}_{min} to 0%.

Shut-off operation (CLOSED)

The following function can be implemented with a 0...10 V signal in 2...10 V mode:

Reference signal Y	Volume flow	Function
< 0.1 V *	0	Damper CLOSED, VAV controller inactive
0.2...2 V	\dot{V}_{min}	Operating level \dot{V}_{min} active
2...10 V	$\dot{V}_{min} \dots \dot{V}_{max}$	Modulating operation $\dot{V}_{min} \dots \dot{V}_{max}$

* Please note: The controller / DDC must be capable of pulling the reference signal to 0 V.

Control functions (continued)

Note

The VAV control circuit – in open loop operation – is the responsibility of the supplier of the VAV controller.

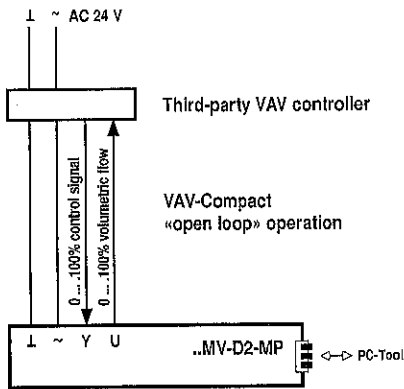
**Open loop operation**

This control function deactivates the integrated CAV / VAV control function. The VAV-Compact works as a modulating actuator with an integrated volumetric flow sensor. The MP-Bus is not available if open loop operation is active.

- Typical application: Pressure-independent control of CAV / VAV units in the comfort zone, similar to the standard VAV-Compact
- Actuator:
 - Control: The actuator is controlled by means of an analogue control signal, e.g. 0...10 V, and moves to the defined position.
 - Running time: The running time in open loop mode is fixed at 150 s.
- Volumetric flow sensor:
 - Actual value signal: Selectable signal (0...10 V or 2...10 V) corresponding to 0...100% of \dot{V}_{nom} . The \dot{V}_{nom} setting and/or calibration of the volumetric flow sensor are the responsibility of the VAV unit manufacturer.

Application

New or retrofit solutions in conjunction with VAV controllers without an actuator and sensor unit from various third-party manufacturers, e.g.:
 -- Siemens RXC ...– TAC Xenta ...

Master/slave connection

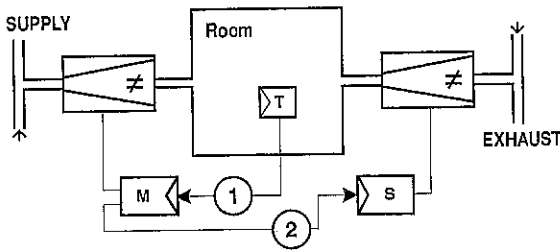

Principle:

1. A reference signal, e.g. from a room temperature controller, is connected to the master input. \dot{V}_{min} and \dot{V}_{max} are set on the master controller.
2. The volumetric flow actual value signal from the master acts as a reference signal for the slave controller. The master is installed on the supply or exhaust air side, depending on the application. See "Determination of the master controller".

For connection diagram, see page 5 ... 6.

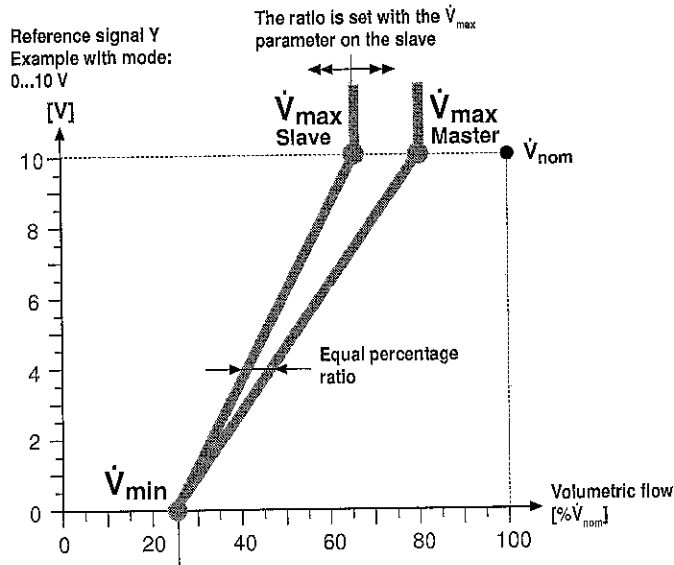

The slave \dot{V}_{min} setting «0%» forms the pivot and intersection point

Determination of the master controller

- If both units have:
- Non-identical \dot{V}_{nom} settings, the controller with the lower \dot{V}_{nom}
 - Identical \dot{V}_{nom} settings, the controller with the higher air volume setting acts as master
 - **Positive pressure in the room**
Master: Supply air unit Slave: Exhaust air unit
 - **Negative pressure in the room**
Master: Exhaust air unit Slave: Supply air unit

Room pressure ratio

In a master/slave connection, any changes in the air system of the master (supply pressure too low, e.g. due to a pressure control fault) are detected and reported to the slave. This guarantees an equal percentage ratio of supply air to exhaust air.

In a master/slave configuration, only one controller can act as master. However, one master controller can control several parallel slave controllers.

When are master/slave connections used?

- In systems with air volume controllers in the supply and exhaust air that are required to work sequentially
- When an equal percentage ratio of supply air to exhaust air is specified.

Operating volumetric flow settings

The \dot{V}_{max} and \dot{V}_{min} values used for the required volumetric flow are set on the master and transferred to the slave by means of a reference signal.

CAV application

In constant air volume applications, operating mode control (CLOSED / \dot{V}_{min} , etc.) is only set on the master controller.

Slave setting if the room pressure ratio is balanced

The \dot{V}_{min} setting on the slave is always 0%. If the room pressure ratio is 1:1 and all controllers are the same size, the slave controller is set to \dot{V}_{max} 100% / \dot{V}_{min} 0%.

Slave setting if the room pressure ratio is unbalanced

The \dot{V}_{min} setting on the slave is always 0%.

Setting with % scale on the ZEV setting device

The ratio of slave volume to master volume is set as follows with the \dot{V}_{max} value on the slave controller:

$$\dot{V}_{max} S\% = \frac{\dot{V}_{max} S \cdot \dot{V}_{nom} M}{\dot{V}_{max} M \cdot \dot{V}_{nom} S} \cdot 100$$

$$\dot{V}_{max} S\% = \dot{V}_{max} \text{ value that must be set on the controller in \%}$$

$$\dot{V}_{nom} M = \text{Nominal volume of the master unit in m}^3/\text{h}$$

$$\dot{V}_{max} M = \text{Maximum volume of the master unit in m}^3/\text{h}$$

$$\dot{V}_{nom} S = \text{Nominal volume of the slave unit in m}^3/\text{h}$$

$$\dot{V}_{max} S = \text{Maximum volume of the slave unit in m}^3/\text{h}$$

Setting with PC-Tool / ZEV (new)

These two setting tools can be used to enter the volumetric flow ratio directly in m^3/h , l/s or cfm , i.e. there is no need to calculate the setting ratio.

Example

Required: Positive pressure in the room with 20% excess air

- Supply air unit: \dot{V}_{nom} 1600 m^3/h / \dot{V}_{max} 1500 m^3/h
- Exhaust air unit: \dot{V}_{nom} 2400 m^3/h / \dot{V}_{max} 1200 m^3/h

Find: \dot{V}_{max} setting of the slave controller

$$53\% = \frac{1200 \cdot 1600}{1500 \cdot 2400} \cdot 100$$

Parallel connection

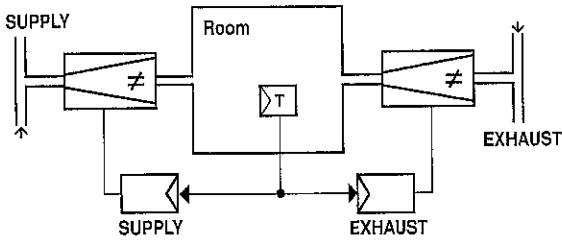

Principle:

The reference signal of the temperature controller is connected in a parallel circuit with the reference value inputs of the supply and exhaust air controllers. The operating volumetric flows \dot{V}_{max} and \dot{V}_{min} are set on both controllers.

For connection diagram, see page 5 ... 6.

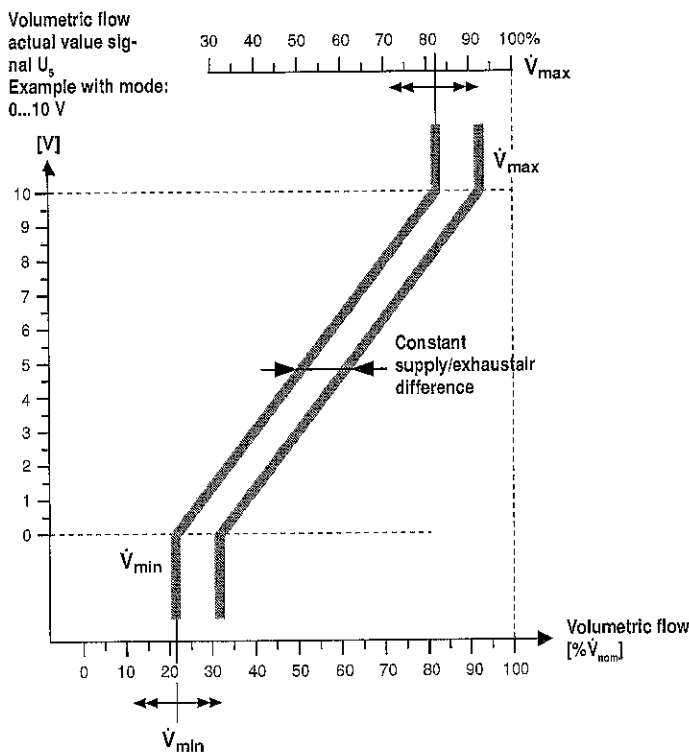

Room pressure ratio

In a parallel connection, the two VAV units are operated independently of one another with a common reference signal. The operating volumetric flows of the supply and exhaust air units must be set according to the required room pressure ratio.

The supply and exhaust air controllers work independently of one another, i.e. if a fault occurs in the supply or exhaust air system, the room pressure ratio is impaired for technical reasons. In the worst case, the unit tolerances may be accumulated. This circumstance must be taken into account by the project planning engineer.

When are parallel connections used?

- If air volume controllers operate with parallel supply and exhaust air (controlled by a common reference variable)
- If the supply and exhaust air devices have different sizes and different minimum and maximum volumetric flow settings
- If constant differential control is active between the supply and exhaust air
- In systems with several supply and exhaust air devices
- In circulating air systems for airtight rooms.

Operating volumetric flow settings

The \dot{V}_{max} and \dot{V}_{min} values used for the required volumetric flow must be set on each VAV controller.

CAV application

In constant air volume applications, operating mode control (CLOSED / \dot{V}_{min} , etc.) is set on both controllers.

Setting if the room pressure ratio is balanced

Owing to the proportional assignment of the reference signal to the value ranges for \dot{V}_{max} and \dot{V}_{min} , it is possible to operate VAV units with different nominal widths and differentiated ranges parallel to one another.

Setting if the room pressure ratio is unbalanced

The operating volumetric flows of the supply and exhaust air units must be set according to the difference:

- Positive pressure ratio in the room
Supply air volume > exhaust air volume
- Negative pressure ratio in the room
Exhaust air volume > supply air volume

Operation

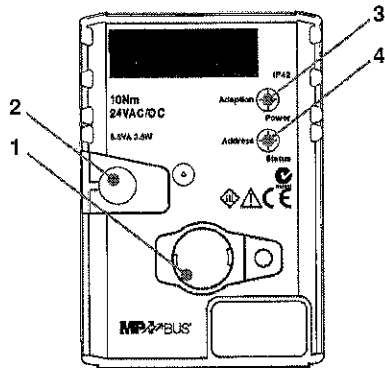

Operating controls and indicators:

- 1 Tool connection with cover
- 2 Manual disengagement
- 3 Button 1 «Adaption», LED 1 «Power»
- 4 Button 2 «Address», LED 2 «Status»

Tool connection (1)

A Belimo operating device can be connected here directly, e.g. PC-Tool or a ZEV hand-operated device for setting and checking the VAV-Compact. This connection is also available if an MP integration is active.

Manual disengagement (2)

The damper blade can be adjusted manually when the system is started up using the pushbutton on the VAV-Compact. Manual adjustments are possible at any time – even if the system is energised – without impairing operation. The position calculation – with visual indication (status LED) – is synchronised automatically in order to prevent deviations as a result of manual control.

Power and operation LED (3)

The status of the 24 V power supply and the readiness of the VAV-Compact for operation are indicated by the green LED (power).

Synchronisation – with visual indication (4)

The position calculation is synchronised in order to prevent permanent deviations as a result of manual control. Correct control of the damper blade position is thus guaranteed. The status LED indicates the progress of the function. Deviations due to manual control are eliminated. This synchronisation also acts as a simple functional check. The synchronisation behaviour can be set according to the application.

Angle of rotation adaption – with visual indication (4)

This function detects the upper and lower spindle end stops and stores them in the VAV-Compact. The running time and the operating range are adapted to the available angle of rotation. By detecting the mechanical end stops, it is possible to approach the end position gently and protect the actuator and damper mechanisms. The status LED indicates the progress of the function. The adaption behaviour can be set according to the application.

Function	Meaning	Yellow LED
Air shortage	Damper opens because the actual volume is too low	LED off
Set volume reached	Control loop balanced	LED flashes alternately with green LED
Excess air	Damper closes because the actual volume is too high	LED on

VAV service mode (V1) – visual indication (LED) for the VAV control loop Service mode is deactivated during normal operation. It can be activated using the two buttons on the VAV-Compact:

- **To activate service mode** (green LED flashes):
 - Press the «Adaption» and «Address» buttons simultaneously (> 3 seconds)
- **To deactivate service mode:**
 - Disconnect the 24 V supply briefly
 - Press one of the two buttons again
 - Service mode is deactivated automatically after 2 hours

Note
When the Service mode is active, the other key functions are out of operation.





















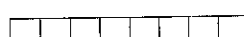
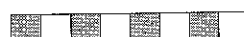

Bus function – addressing (4)

The address button assigns an MP-Bus address (MP1...8) to the VAV-Compact and switches the device to the bus function. For details of the procedure, refer to "MP-Bus integration"

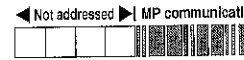

MP-PP communication active (4)

The address button assigns an MP-Bus address (MP1...8) to the VAV-Compact and switches the device to the bus function.

LED function table

Application	Function	Description / action	LED pattern	Adaption 	Address 	LED 1 Power LED 2 Status
N1 Operation	Status information	- 24 V power supply OK - VAV-Compact ready for operation	LED 1  LED 2 			
S1 Service function	Synchronisation	Synchronisation started by: a) Operating / service device b) Manual disengagement on the VAV-Compact c) Power ON behaviour	LED 1  LED 2 			
S2 Service function	Adaption	Adaption started by: a) Operating / service device b) Button on VAV-Compact	LED 1  LED 2 			
V1 VAV service	VAV service active	a) «Adaption» and «Address» buttons pressed simultaneously b) VAV service deactivated: - When the 24 V power supply is disconnected - When the two buttons are pressed again - Automatically after 2 hours	LED 1  LED 2  			
	Air shortage	Damper opens because the actual volume is too low	LED 1  LED 2 			
	Set volume reached	Control loop balanced	LED 1  LED 2 			
	Excess air	Damper closes because the actual volume is too high	LED 1  LED 2 			
B1 Bus control	Addressing via MP master (acknowledgement on VAV-Compact)	a) Addressing triggered on the MP master	LED 1  LED 2 			
		b) Press the address pushbutton LED indicates active communication again as soon as the addressing function has finished	LED 1  LED 2 			
B2 Bus control	Addressing via MP master (with serial number)	Addressing triggered on the MP master LED indicates active communication again as soon as the addressing function has finished	LED 1  LED 2 			
B3 Bus control Communication	MP-PP communication	Indicates active communication with the MP master or an operating / service device	LED 1  LED 2 			

Legend:

-  Green LED (power) lit
-  Yellow LED (status) lit
-  Yellow LED lit intermittently

Settings

Function	Settings, limits	Operating device		Remarks, notes
		PC-Tool (Version V3.x or higher)	ZEV *	
Operating volumetric flow				
$\dot{V}_{nom}^{1)}$	Unit-specific value	r	–	1) This value is fixed by the OEM when the VAV-Compact is calibrated
\dot{V}_{max}	30...100% of \dot{V}_{nom}	r/w	r/w	r/w
$\dot{V}_{min}^{2)}$	x ²⁾ ...100% of \dot{V}_{nom}	r/w	r/w	2) This value is determined by the minimum setting limit, see below. 0% allowed for shut-off operation
\dot{V}_{mid}	$\dot{V}_{min} \dots \dot{V}_{max}$	r/w	–	CAV step in the range from \dot{V}_{min} to \dot{V}_{max}
Reset OEM values		r/w	w	Restores the OEM basic values ($\dot{V}_{max} / \dot{V}_{min}$)
Control loop	Actual / set volume deviation	r	r ³⁾	3) With LED
Mode	0...10 V / 2...10 V	r/w	w ⁴⁾	4) The mode can be altered but not indicated!
Variable settings:				
– Reference signal Y (terminal 3)	– Start value: 0.6...30 V – Stop value: 2.6...32 V	r/w	–	
– Actual value signal U (terminal 5)	– Start value: 0.6...8 V – Stop value: 2.6...10 V	r/w	–	
Type	Type designation	r	–	Belimo product designation
Position	16 characters	r/w	–	Indication in operating and bus devices
Designation	16 characters	r/w	–	Indication in operating and bus devices
Serial number	nnnnn-nnnnn-nnn-nnn	r	–	Belimo designation: ID and serial number
Address	MP1...MP8	r/w	–	MP-Bus address
Calibration value	Unit-specific value	r	–	Unit-specific parameter
Minimum setting limit		r	–	Smallest possible control range (unit and/or manufacturer-specific value)
Controller function	Air volume / open loop	r/w	–	
Sensitivity	Normal / damped	r/w	–	Setting for open loop input signal
U _s feedback function	Volumetric flow / damper position	r/w	–	
Range of rotation	– Adapted 33...95° – Electronically limited 33...95°	r r/w	–	
Direction of rotation at Y=100%	– cw – ccw	r/w	–	
Torque	100 / 75 / 50 / 25%	r/w	–	
Power ON behaviour	– No action – Adaption – Synchronisation	r/w	–	Power ON behaviour
Synchronisation behaviour	– Y = 0% – Y = 100%	r/w	–	Synchronisation set to Y = 0 or 100%
Bus fail position	– Last value – CLOSED – \dot{V}_{min} – \dot{V}_{max} – OPEN	r/w	–	MP-Bus function Behaviour if the bus master is faulty
Operating data	– Operating time – Running time– Ratio	r rr	–	
Alarm signals	– Setting range too large – Mechanical overload – Stop & go ratio too high	r/w r/wr/w	–	
Version overview	– Firmware – Config. table ID	r r	–	

* A new scale sticker must be used! Please contact your local Belimo representative.

Note: Settings can be saved and printed with PC-Tool V3.x.

Operating and fault messages

Operating data recording The VAV-Compact controller records the following operating data, which can be read out with PC-Tool or via the MP-Bus master if MP-Bus integrations are active:

Operating time

Number of hours for which the VAV-Compact was connected to the power supply.

Active time

Number of hours for which the VAV-Compact was mechanically in motion and connected to the power supply.

Stop & go ratio

Ratio of active time to operating time (formula = active time [h] / operating time [h] x 100).

The VAV-Compact generates the error messages described below in the corresponding situations. The error messages can be read out with PC-Tool or on the ZEV (new) and are also indicated via the bus master if MP-Bus integrations are active.

«Setting range too large»

Occurs if, when the angle of rotation is limited to 60° for example, the setting range suddenly exceeds > 60° owing to a mechanical defect (angle of rotation limiting altered or loose). This is detected by the VAV-Compact and the above message is generated.

Mechanical overload

«Stop & go ratio too high» occurs if the stop & go ratio exceeds 20%, in other words if the actuator moves too frequently in relation to its operating time. Possible cause: Unstable reference signal, e.g. because the upstream room temperature cascade is oscillating.

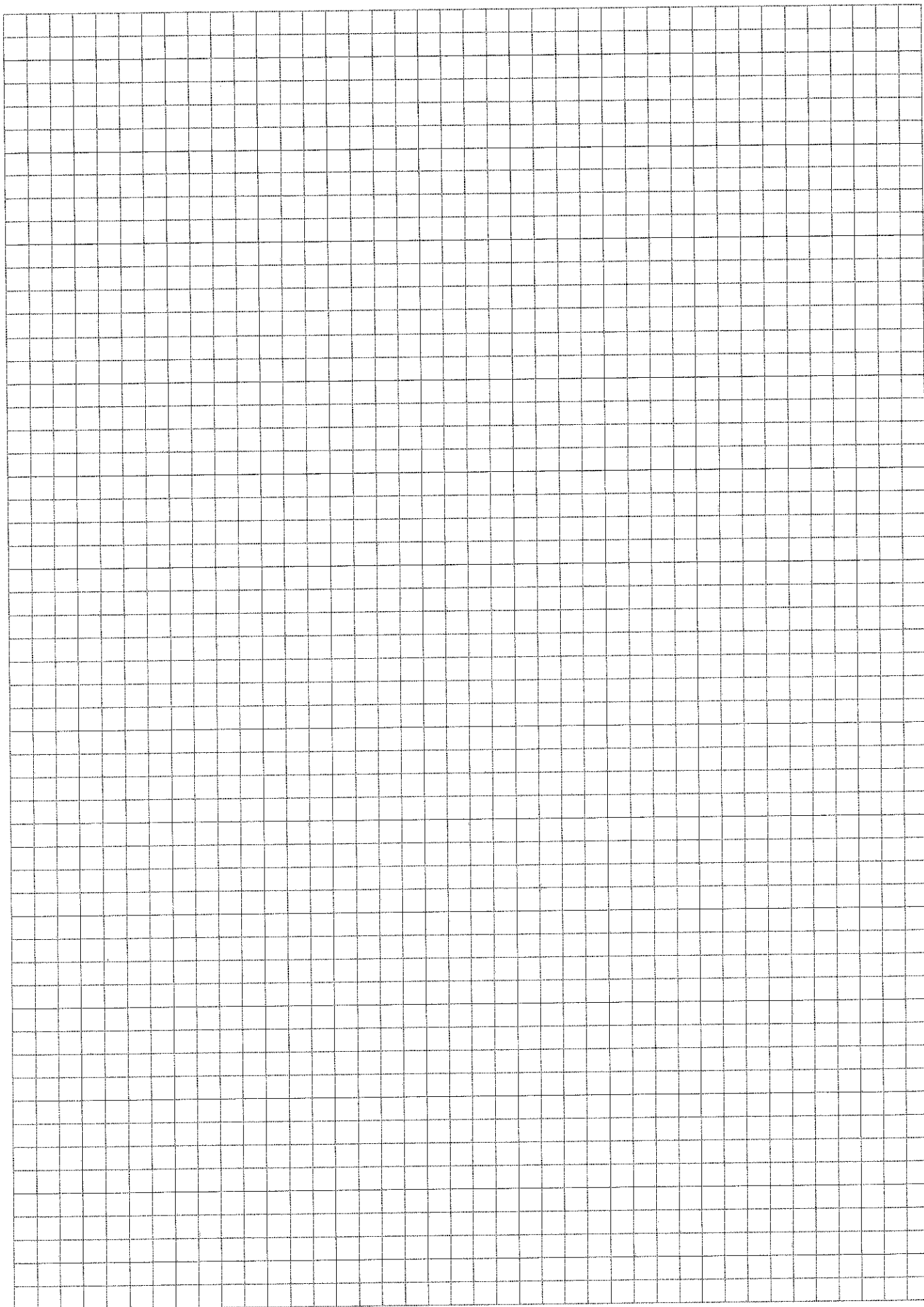

Table of contents

Single-duct systems

CAV room solution with motion detector	2
VAV room solution with 0...10 V control	3
VAV room solution with CR24 room controller	4

Dual-duct systems

VAV dual-duct solution with CR24 room controller	5
--	---

More VAV applications, including lists of materials and specification texts, can be found in application library CR24 under www.belimo.com.

Energy-optimised VAV/CAV system solutions for fan regulators for room ventilation.

Functional/product descriptions and typical applications can be found in the system documentation for the COU24-A-MP optimiser under www.belimo.com.

Single-duct systems

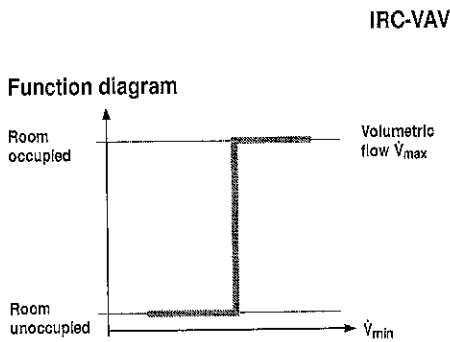

IRC-VAV CAV room solution with motion detector

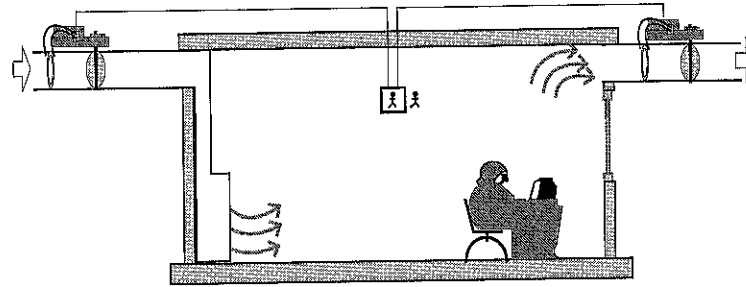

CAV single-duct system, occupancy-controlled

Brief description

Control solution for CAV single-room application

CAV single-duct system, occupancy-controlled
 Stand-alone operation or integrated in a building automation system (I/O integration)

Functions The CAV controller is controlled by means of the motion detector in two modes on the basis of room occupancy (\dot{V}_{min} ... \dot{V}_{max}):

- Room unoccupied: constant air volume \dot{V}_{min}
- Room occupied: constant air volume \dot{V}_{max}

Motion detector With switching output for low switching capacity (load 0.24 mA)

VAV-Compact control device ..MV-D2-MP VAV-Compact control device for supply air, exhaust air or mixing units, comprising a sensor, VAV controller and actuator for pressure-independent air volume controls.

- Damper position feedback controlled via the MP-Bus for demand based fan optimisation.

Wiring diagram

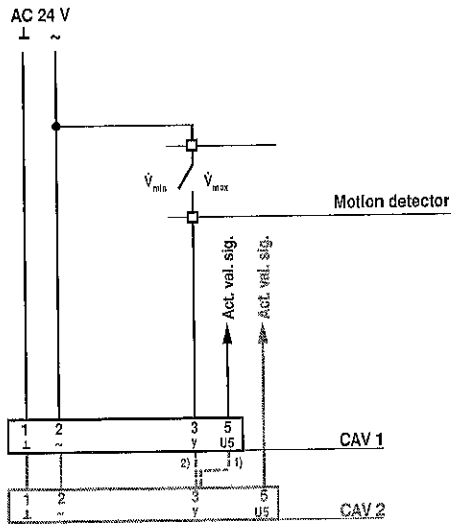

Notes

- Connection and terminal designations of the motion detector in accordance with the manufacturer's specification
- Mode setting on the CAV controller: 0...10 V or 2...10 V

Single-duct systems (continued)

IRC-VAV VAV room solution with 0...10 V control

Function diagram

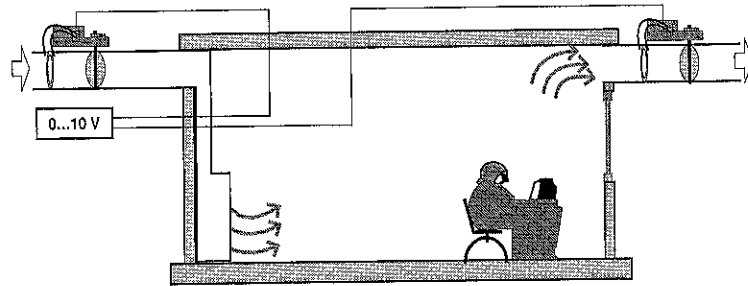
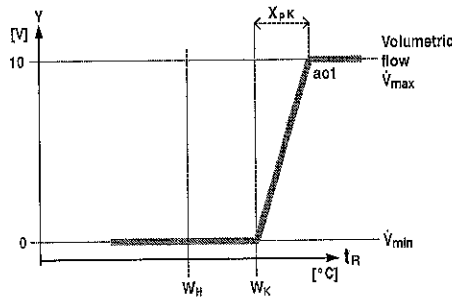

VAV single-duct system, room temperature-controlled

Brief description

Control solution for VAV single-room application

VAV single-duct system, room temperature-controlled
 Stand-alone operation or integrated in a building automation system (I/O integration)

Functions The 0...10 V single-room or DDC controller controls the VAV controller with a variable air volume in the range from \dot{V}_{min} to \dot{V}_{max} , depending on the room cooling needs.

Single-room or DDC controller With 0...10 V output signal (cooling sequence).
 Controller functions in accordance with the manufacturer's specification.

VAV-Compact control device ..MV-D2-MP VAV-Compact control device for supply air, exhaust air or mixing units, comprising a sensor, VAV controller and actuator for pressure-independent air volume controls.
 • Damper position controlled via the MP-Bus for demand based fan optimisation.

Wiring diagram

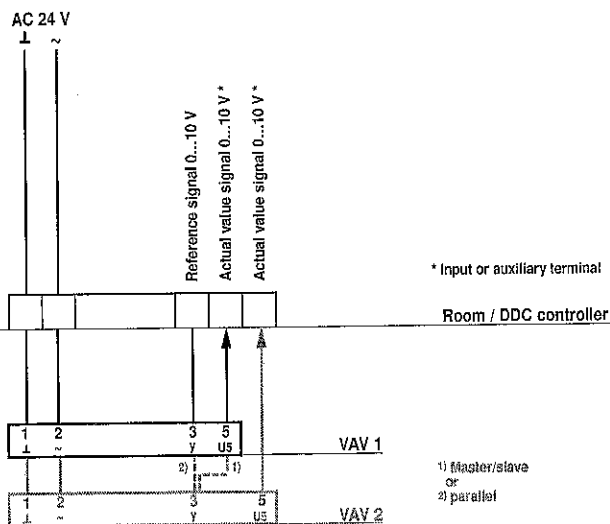

Notes

- Connection and terminal designations in accordance with the controller manufacturer's specification
- Mode setting on the VAV controller: 0...10 V

Single-duct systems (continued)

IRC-VAV VAV room solution with CR24 room controller

Function diagram

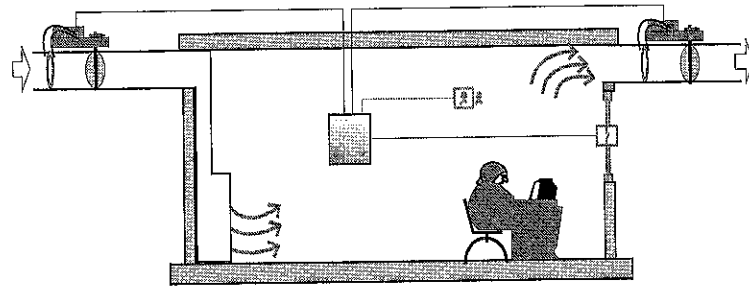
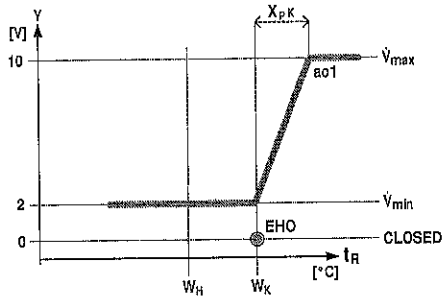

VAV single-duct system, room temperature-controlled

Brief description

Note

For technical data and a detailed description of functions, see CR24 product information.

Control solution for VAV single-room application

VAV single-duct system, room temperature-controlled
Stand-alone operation or integrated in a building automation system (I/O integration)

Functions

The CR24-B1 single-room controller controls the connected VAV controllers with a variable air volume in the range from \dot{V}_{min} ... \dot{V}_{max} , depending on the room cooling needs. Other functions can be optionally connected (e.g. with a motion detector): energy hold off, standby, etc.

Room temperature controller
CR24-B1(automatic) CR24-A1

- Room temperature controller (15 ... 36°C) with an integrated or external temperature sensor
- Mode selection with a pushbutton and three LEDs: AUTO, ECO (reduced room temperature for standby or night operation) and MAX (flushing operation with 15' timer)
- Room protection function (frost/excess temperature)
- Inputs for energy hold off, standby operation, external temperature sensor, summer/winter compensation
- VAV system output
- Self-resetting start-up and service function
- Tool connection for diagnostics, settings and trend recordings

VAV-Compact control device
..MV-D2-MP

- VAV-Compact control device for supply air, exhaust air or mixing units, comprising a sensor, VAV controller and actuator for pressure-independent air volume controls.
- Damper position controlled via the MP-Bus for demand based fan optimisation.

Wiring diagram

Input and output assignment

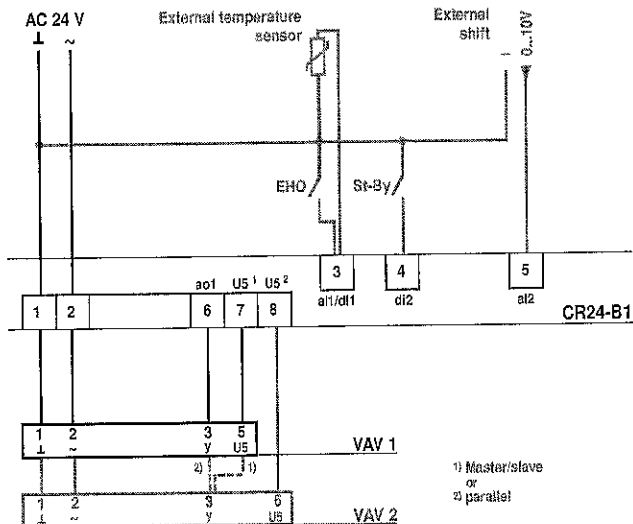

Functions	Description	Assignment
VAV	VAV system output (0) 2 ... 10 V	Output ao1
Optional functions	Description	Assignment
EHO	Energy hold off (window)	Output di1
Sensor	External temperature sensor NTC 5K	Output ai1
Shift	External shift 0 ... 10 V (Summer/Winter compensation)	Output ai2

Note

Terminal designations in accordance with the Belimo final controlling element.

Configuration, settings

DIP switches



DIP Switch	Setting	Function
1	P-Band	normal / wide
2	di2	Stand by / Change over

Notes

- Further VAV applications such as boost (fast heat up), night cool down (air heated with water or electrically), night cooling, combination available with chilled ceiling. See www.belimo.com
- Mode setting for VAV controller for this application: 2 ... 10 V

Setpoint WH range: 15...36°C

Dual-duct systems

IRC-VAV VAV dual-duct solution with CR24 room controller

Function diagram

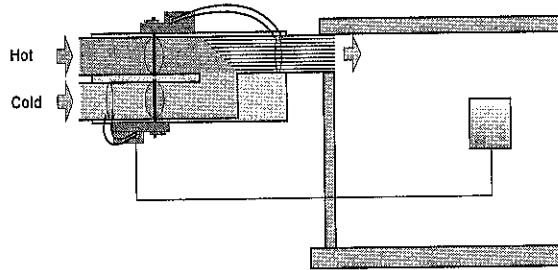
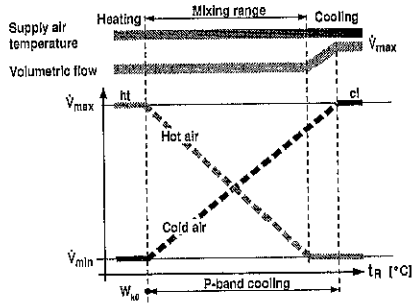

VAV dual-duct system, room temperature-controlled

Brief description

Note

For technical data and a detailed description of functions, see CR24 product information.

Functions

Control solution for VAV single-room application

VAV dual-duct system, room temperature-controlled
Stand-alone operation or integrated in a building automation system (I/O integration)

The two air volume controllers mix the hot and cold air supplied by the dual-duct air conditioning system to obtain the condition requested by the CR24-B1 room temperature controller. The constant air volume (CAV) controller for the hot air adjusts to the set \dot{V}_{max} volume for heating. The variable air volume (VAV) controller for the cold air adds the variable amount of cold air requested by the room temperature controller. If cooling needs exceed the hot air volume, the hot-air part is shut off and only cold air is supplied.

Optional: The cold-air part can be shut off by means of a switching contact at input d1.

Room temperature controller
CR24-B1(automatic) CR24-A1

- Room temperature controller (15 ... 36 °C) with an integrated or external temperature sensor
- Mode selection with a pushbutton and three LEDs: AUTO, ECO (reduced room temperature for standby or night operation) and MAX (flushing operation with 15' timer)
- Room protection function (frost/excess temperature)
- Inputs for cold air shut-off, external temperature sensor, summer/winter compensation
- VAV system output
- Self-resetting start-up and service function
- Tool connection for diagnostics, settings and trend recordings

VAV-Compact control device
..MV-D2-MP

VAV-Compact control device for supply air, exhaust air or mixing units, comprising a sensor, VAV controller and actuator for pressure-independent air volume controls.

Wiring diagram

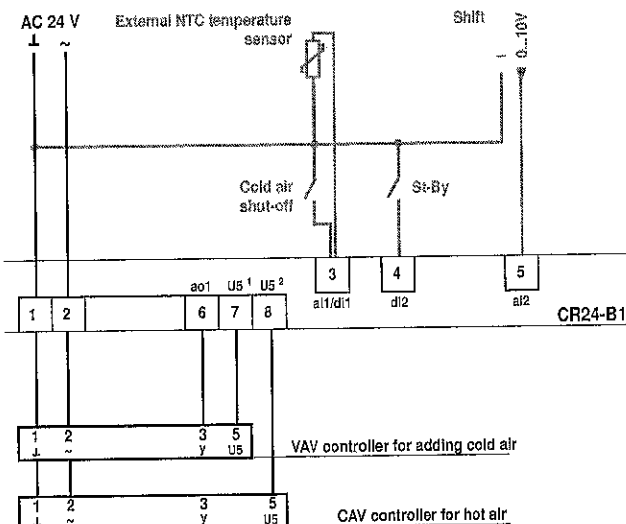

Input and output assignment

Functions	Description	Assignment
VAV	VAV system output (0) 2 ... 10 V	Output ao1
Optional functions	Description	Assignment
Shut-off CA	Cold air shut-off	Input di1
Sensor	External temperature sensor NTC 5K	Input ai1
Shift	External shift 0 ... 10 V (Summer/Winter compensation)	Input ai2

Configuration, settings

DIP switches



1	P-Band	normal	wide
2	di2	Stand by	Change over

Setpoint WH range: 15...36 °C

Notes

- Terminal descriptions correspond to the Belimo actuator connection.
- Mode setting for the VAV controller for this application: 2 ... 10 V

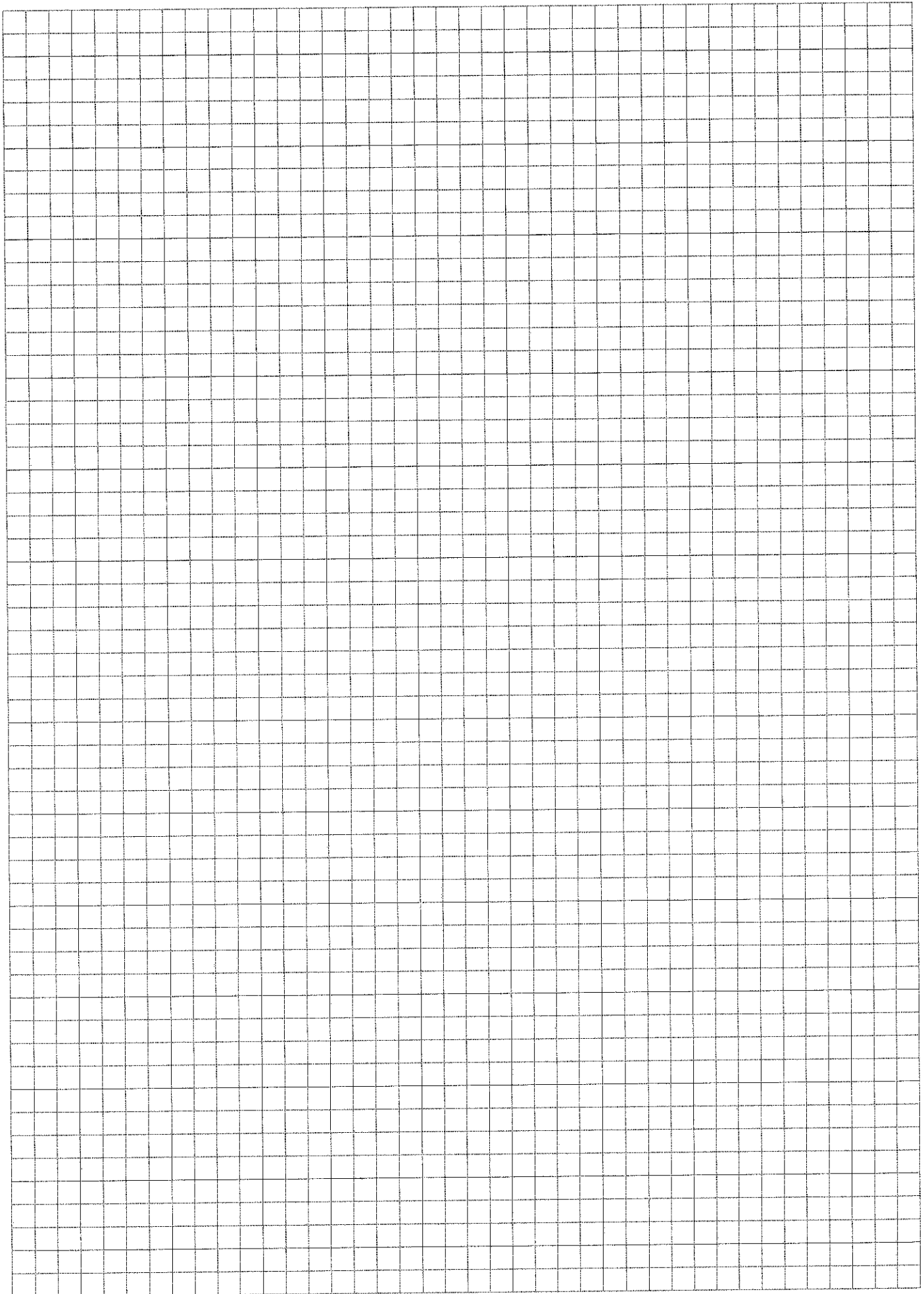

Table of contents

MP-Bus integration

General	2
Mode of operation	2
Integration for LonWorks	2
Integration for EIB / KNX systems	3
Integration with DDC / PLC controllers	3
Integration with COU24-A-MP fan optimiser	3
Addressing	4
Connection, MP-Bus topology, power supply and wiring	4
Cable lengths	5
Control / operating volumetric flow settings	7
Bus fail function	8
Sensor integration	9

General

Conventional or via MP-Bus

Up-to-date and more detailed information about bus solutions can be found under www.belimo.com.

VAV-Compact controllers can be controlled either conventionally or via the MP-Bus. Integrations in LONWORKS®, EIB / KNX or DDC systems with an MP interface can thus be realised simply and inexpensively.

Mode of operation

MP address

The assignment of an MP address turns a standard VAV-Compact into a bus-capable system controller with considerable added value.

In bus mode, the VAV-Compact controller is supplied with a reference signal over the MP-Bus from the higher-level building automation system and adjusts to the specified volumetric flow. The VAV-Compact is switched to MP-Bus mode automatically as soon as it is assigned an MP address. One active or passive sensor or one switch can be connected to each VAV-Compact. This input value can be used in the higher-level system, e.g. for VAV control in room temperature or other applications.

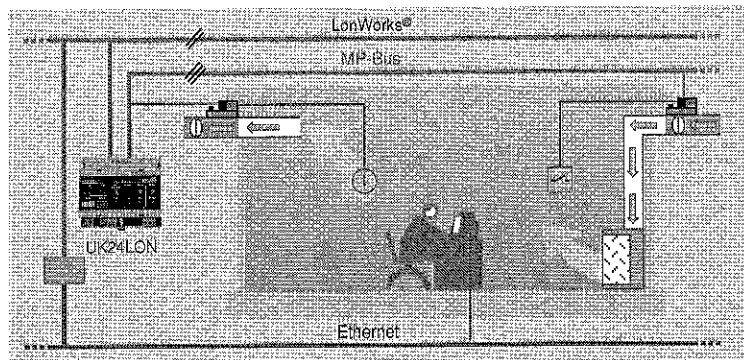

For the direct integration of VAV controllers in a LONWORKS® system there are new VAV-Compact controllers available in a LONMARK® certified LON version:

- LMV-D2LON
- NMV-D2LON

MP-Bus

The VAV-Compact can be interconnected with up to eight Belimo MP devices (damper actuators, valve actuators, VAV-Compact controllers) thanks to the integrated communication principle over the Belimo MP-Bus. These slave devices are supplied by the higher-level bus master with a digital control signal over the MP-Bus and then moved to the position dictated by this signal.

Integration for LONWORKS®

The LONMARK® certified UK24LON gateway connects the Belimo MP-Bus with LONWORKS®. Up to eight MP actuators can be connected on the MP-Bus side.

The UK24LON allows the actuators to be digitally controlled via the MP-Bus and send back their current operating status. It converts the digital information from the controller and the feedback into standardised network variables (SNVTs). The functions of the field devices can thus be directly integrated into LONWORKS®.

Damper actuator object #8110

The actuator object is used to map the functions of the MP actuators to the LONWORKS® network. There are eight of these objects in the UK24LON, i.e. one per MP actuator.

Open loop sensor object #1

An optional sensor or switch can be connected to each MP actuator. The open loop sensor object transfers the linked sensor values to the LONWORKS® network. VAV controllers are also available in a LONMARK® certified LON version as an alternative to cost-effective integration via the UK24LON; LMV-D2LON / NMV-D2LON.

For more detailed information, see UK24LON product information.

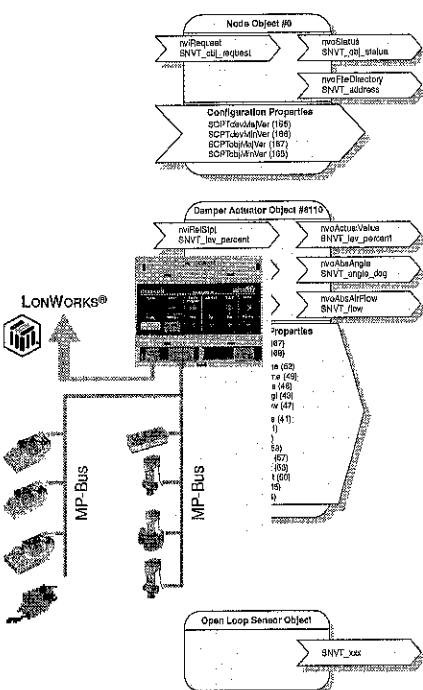

Integration for EIB / KNX systems

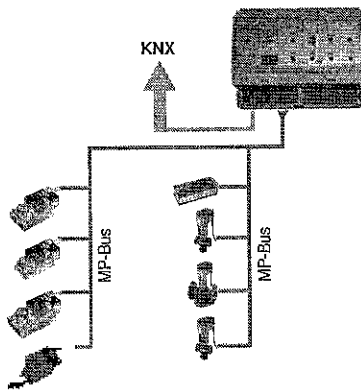

The KNX certified UK24EIB allows up to eight MP actuators or VAV-Compact controllers to be digitally controlled via the MP-Bus and send back their current operating status. It translates the digital information from the controller and the feedback into KNX telegrams. The functions of the MP field devices can thus be directly integrated into KNX systems.

Sensor connection

An optional sensor or switch can be connected to each MP actuator. The analogue sensor values are digitised in this way and transferred to the KNX system via the UK24EIB.

For more detailed information, see UK24EIB Product Information.

Integration with DDC / PLC controllers

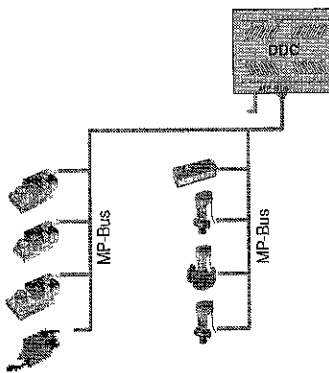

DDC / PLC devices with an MP interface are available from several manufacturers. These control devices can thus communicate directly and digitally with the connected MP field devices.

Sensor integration

An optional sensor or switch can be connected to each MP actuator. The analogue sensor values are digitised in this way and supplied to the DDC / PLC system for its control functions.

MP-Bus protocol

DDC / PLC manufacturers who would like to implement the MP-Bus protocol in their controllers can be provided with the technical specifications on request.

For more information, please contact the DDC / PLC supplier or your Belimo representative.

Integration with COU24-A MP fan optimiser

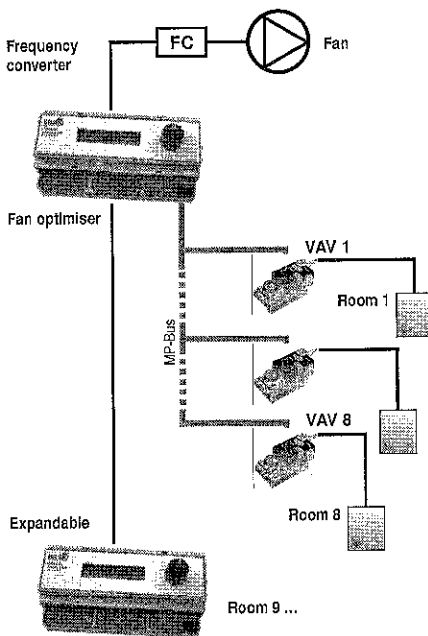

MP-Bus controlled variable and constant air volume systems for room ventilation applications with fans controlled by a frequency converter.

The system is operated by the fan optimiser with optimum damper positions based on the current demand signals. The objective is to keep the pressure loss through the VAV units as low as possible and thus permanently reduce operating costs by decreasing the fan output. The damper positions of each VAV-Compact controller are recorded, transferred via the MP-Bus to the fan optimiser and used there as a control variable for regulating the fan controlled by the frequency converter.

As a result of this technology – which is based on the Belimo MP-Bus – up to 50% energy savings can be achieved compared to conventional systems with fans controlled by air-duct pressure.

System size: Any
 Number of VAV / CAV units per fan optimiser: 1...8

For more detailed information, see
 • COU24-A-MP fan optimiser system description
 • COU24-A-MP product information

Addressing

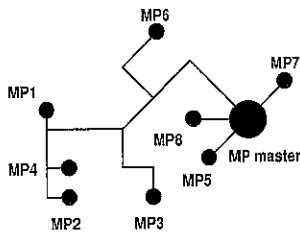

Each device in a bus system must be uniquely identifiable. Each MP slave must therefore be assigned an address.
Address range: MP1...8

The slaves can be addressed either directly on the MP master unit or by means of a Belimo operating device. They are addressed using the serial number (numerical / barcode) or with the address pushbutton on the MP device.

Procedure: Refer to the documentation for the MP master unit or the PC-Tool online help (<F1> function).

Connection, MP-Bus topology, power supply and wiring

MP-Bus connection

The MP-Bus connection is a network for 1...8 Belimo MP devices. Like the VAV-Compact, it consists of a 3-pole connection for MP-Bus communication and the AC or DC 24 V power supply.

Neither special cables nor terminating resistors are required for the wiring.

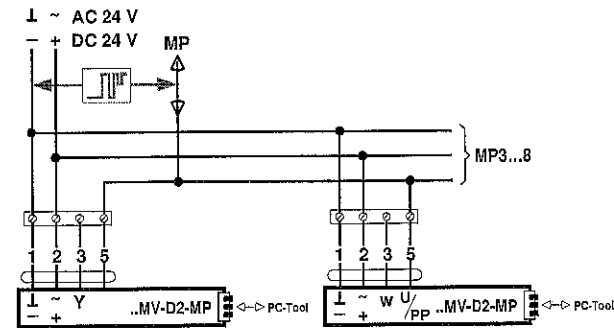

- The cable lengths (see calculation overleaf) are limited by:
- The sum of the performance data of the connected MP devices,
 - The type of supply (AC 24 V via the bus or DC 24 V)
 - The cable cross-section.

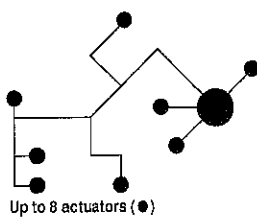

MP-Bus topology

The cables of up to eight MP devices / VAV controllers can be laid in a freely definable bus topology. The following topologies are permitted: star-shaped, ring-shaped, tree-shaped or mixed forms.

Cable lengths

Limits

The cable lengths (see calculation below) are limited by:

- The sum of the performance data of the connected devices, e.g. LMV-D2-MP 5 VA / 3 W
- The type of supply (AC 24 V or DC 24 V)
- The cable cross-section.

MP-Bus cable length for AC 24 V supply via the bus cable

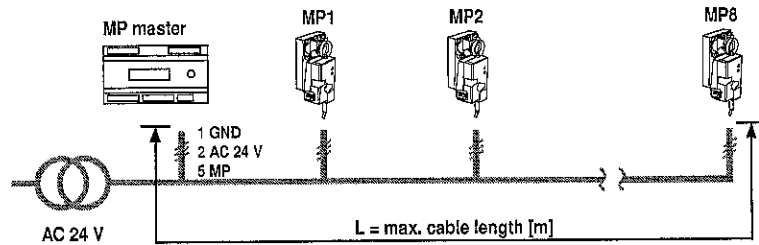

Total power rating of VAV controllers [VA]

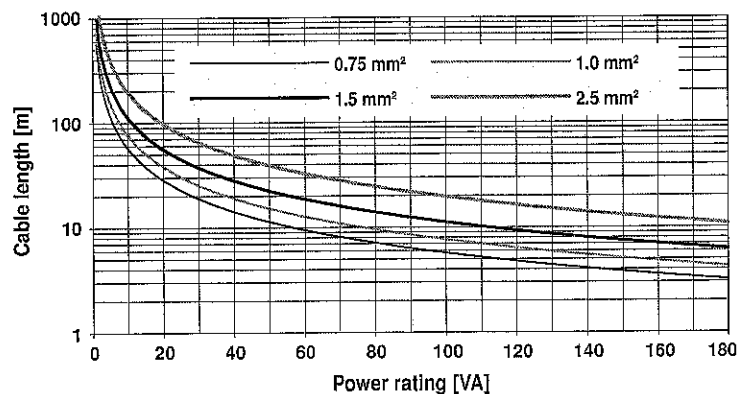

Cable length vs. power rating applies to AC supply (minimum transformer voltage AC 21.6 V)

Calculation of the maximum cable lengths (AC 24 V)

The power ratings (VA) of the individual devices must first be added together. The corresponding cable lengths can then be read from the graph.

Example:

MP-Bus with 4x LMV-D2-MP

Total power rating: $4 \times 5 \text{ VA} = 20 \text{ VA}$

Values read from the graph:

- Cable with wire $\varnothing 0.75 \text{ mm}^2$ requires: cable length 28 m
- Cable with wire $\varnothing 1.0 \text{ mm}^2$ requires: cable length 40 m
- Cable with wire $\varnothing 1.5 \text{ mm}^2$ requires: cable length 54 m
- Cable with wire $\varnothing 2.5 \text{ mm}^2$ requires: cable length 90 m

Cable lengths (continued)

MP-Bus cable length for DC 24 V supply via the bus cable

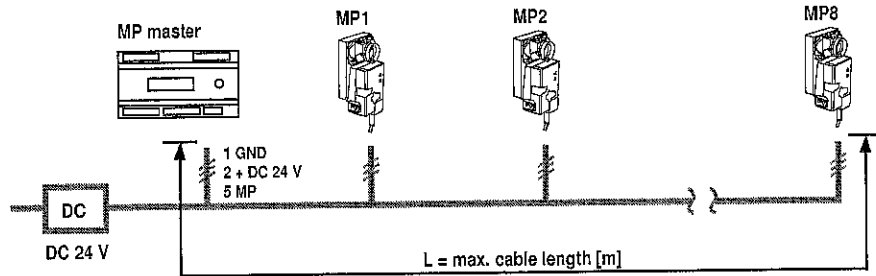

Total power rating of VAV controllers [W]

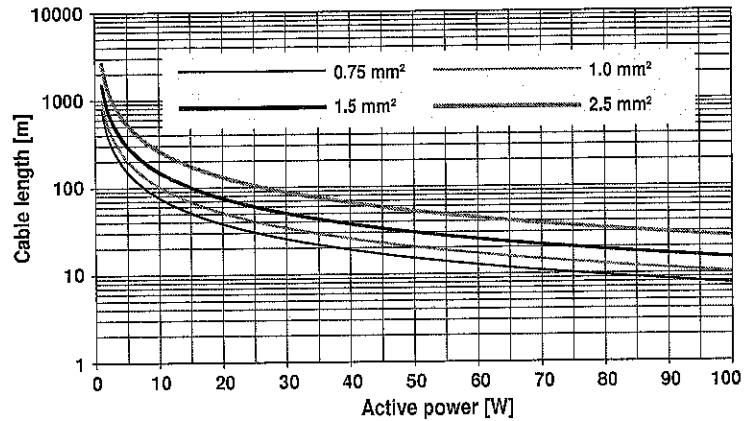

Cable length vs active power applies to DC supply (minimum supply voltage AC 24.0 V)

Calculation of the maximum cable lengths

The power consumption [W] of the individual devices must first be added together. The corresponding cable lengths can then be read from the graph.

Example:

MP-Bus with 4x LMV-D2-MP

Total power rating: $4 \times 3 \text{ W} = 12 \text{ W}$

Values read from the graph:

- Cable with wire \varnothing 0.75 mm² requires: cable length 60 m
- Cable with wire \varnothing 1.0 mm² requires: cable length 80 m
- Cable with wire \varnothing 1.5 mm² requires: cable length 115 m
- Cable with wire \varnothing 2.5 mm² requires: cable length 200 m

Bus cable length for local AC 24 V supply

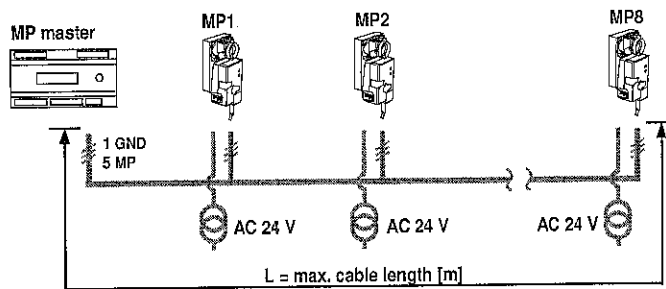

Maximum length of bus cable for local AC 24 V supply

Wire \varnothing mm ²	L = max. cable length [m]
0.75	800
1.0	
1.5	

If the VAV controllers are supplied with AC 24 V locally via a separate transformer, the cable lengths can be significantly increased. The cable lengths indicated in the table apply regardless of the performance data of the connected actuators.

Reference variable and actual volumetric flow in bus mode

In bus mode, the reference variable is specified to the VAV-Compact as a digital signal by the higher-level system via the MP-Bus. The actual volumetric flow signal and the current damper position are supplied to this system for display or control functions.

The 0...100% setpoint selected via the MP-Bus is resolved by the $\dot{V}_{min} / \dot{V}_{max}$ setting of the VAV-Compact controller, i.e.:

- 0% setpoint corresponds to \dot{V}_{min} volume
- 100% setpoint corresponds to \dot{V}_{max} volume

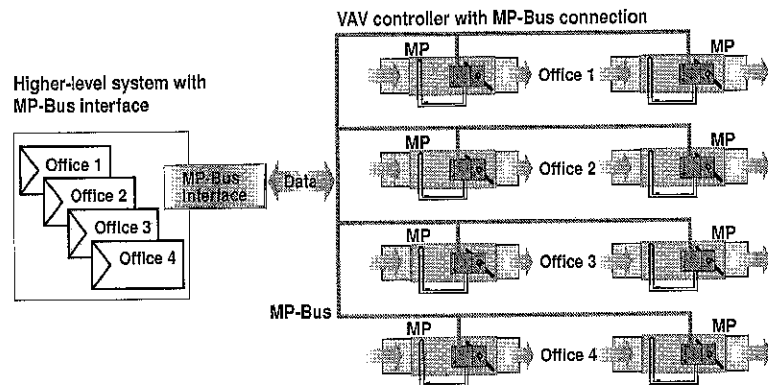

Operating volumetric flow setting $\dot{V}_{min} / \dot{V}_{max}$

Function	Volumetric flow	Range
\dot{V}_{nom}	Nominal	OEM-specific value, depending on the application and the VAV unit type
\dot{V}_{max}	Maximum	30...100% of \dot{V}_{nom}
\dot{V}_{min}	Minimum	0*...100% of \dot{V}_{nom}

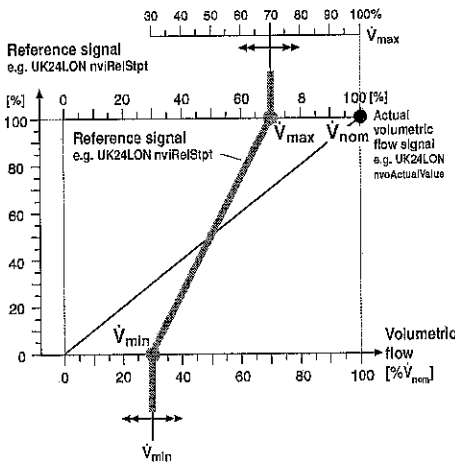

* \dot{V}_{min} must be set to 0% for shut-off operation. For VAV operation, on the other hand, a minimum value higher than the 'minimum setting limit' should be used. See «minimum setting limit» function, page 17.

Open operating volumetric flow setting

The $\dot{V}_{min} / \dot{V}_{max}$ setting can be open if necessary, i.e. the two values can be set to 0 and 100%. In this case, the volumetric flow must be limited in the higher-level system. This operating setting allows the limitation of the volumetric flow to be adjusted without altering the parameters on the VAV controller.

Responsibility for the limiting function passes from the OEM to the system supplier or integrator.

Master/slave and parallel control

Master/slave control

The actual volumetric flow is read from the master VAV controller by the higher-level system and specified to the slave controller as a reference signal.

Parallel control

If the VAV units are operated in parallel, the setpoints for the supply and exhaust air VAV units are transferred in parallel to the two VAV controllers.

Positive and negative room pressure

If a system with positive or negative room pressure is planned, the room pressure ratio must be taken into account in the setpoint calculation.

Example: VAV application with UK24LON

Bus fail function**Response to bus failure**

It is possible to specify the response to an MP-Bus failure, essential maintenance work, faults, etc. on each VAV-Compact controller. This setting can be displayed or changed in PC-Tool Version V3.1 or higher.

The following functions are available:

- CLOSED
- \dot{V}_{min}
- \dot{V}_{max}
- OPEN
- Last value (default setting, last setpoint command received from the bus master)

Sensor integration

Mode of operation

An additional sensor or switch can be connected to the VAV-Compact in MP-Bus mode independently of the VAV control loop. The sensor signal is connected to the reference value input that is not used in MP-Bus mode (connection 3).

The VAV-Compact then acts as an analogue/digital converter for transmitting the sensor signal to the higher-level system. This system must know the physical address (which sensor is connected to which MP device) and be capable of interpreting the corresponding sensor signal. If possible, the sensors should be connected using separate cables to prevent compensation currents. The sensor ground (GND) cable, as a minimum, should be laid separately from the power supply cable over as long a distance as possible.

Signals that can be linked in

- Active sensor with a DC 0...10 V signal
- Passive resistance sensor e.g. Pt1000, Ni1000, NTC
- Switching contacts

MP-Bus cycle time

Typical value 2...8 s

Dependent on the number of connected MP devices and sensors. The cycle time must be taken into account in the application and / or implementation!

Switching contact connection

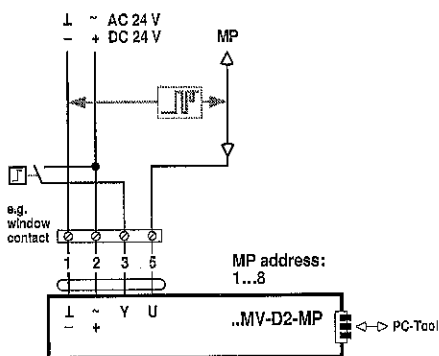

For external switching contacts with control functions in the higher-level system, e.g. window switch for energy hold-off when the window is open, light switch (auxiliary contact) for occupancy-controlled standby circuit.

The cycle time must be taken into account in the implementation!

Switching contact requirement

The switching contact must be able to accurately switch a current of 16 mA at 24 V.

Reference signal Y setting if a switch is connected

The VAV-Compact must be set to 2...10 V mode to enable the states of a connected switch to be evaluated:

The setting can be changed with PC-Tool or a ZEV.

See «settings», page 24.

Passive sensor connection

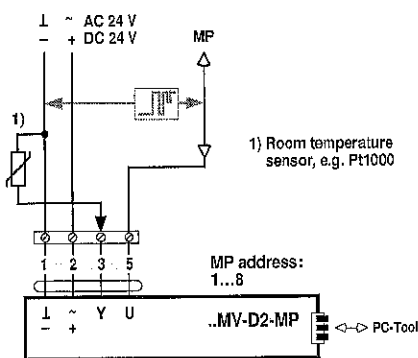

Passive resistance sensors, e.g. Pt1000, Ni1000, NTC, for open and closed-loop control functions in the higher-level system, such as a temperature sensor for monitoring the minimum room temperature. The cycle time must be taken into account in the implementation!

Reference signal Y setting if a passive sensor is connected

No special settings are required.

Active sensor connection

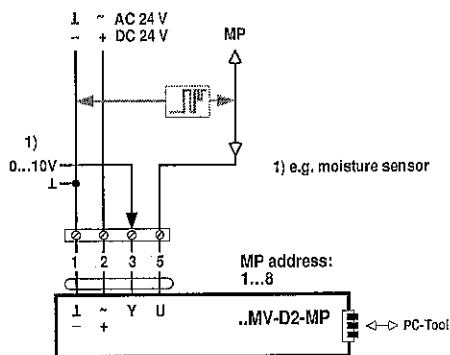

Active 0...10 V sensors for open and closed-loop control functions in the higher-level system, such as a moisture or CO2 sensor. The cycle time must be taken into account in the implementation!

Reference signal Y setting if an active sensor is connected

No special settings are required.

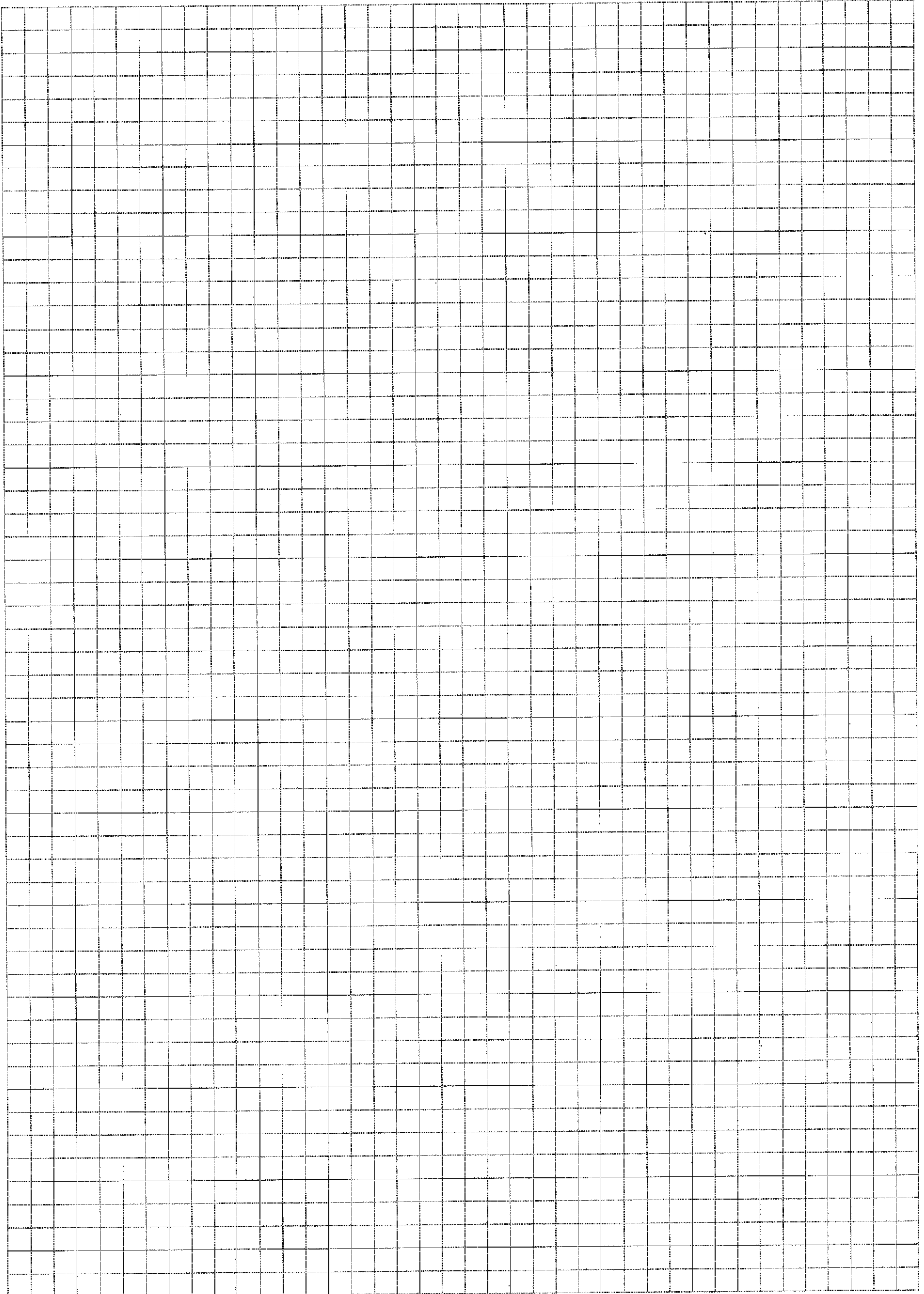
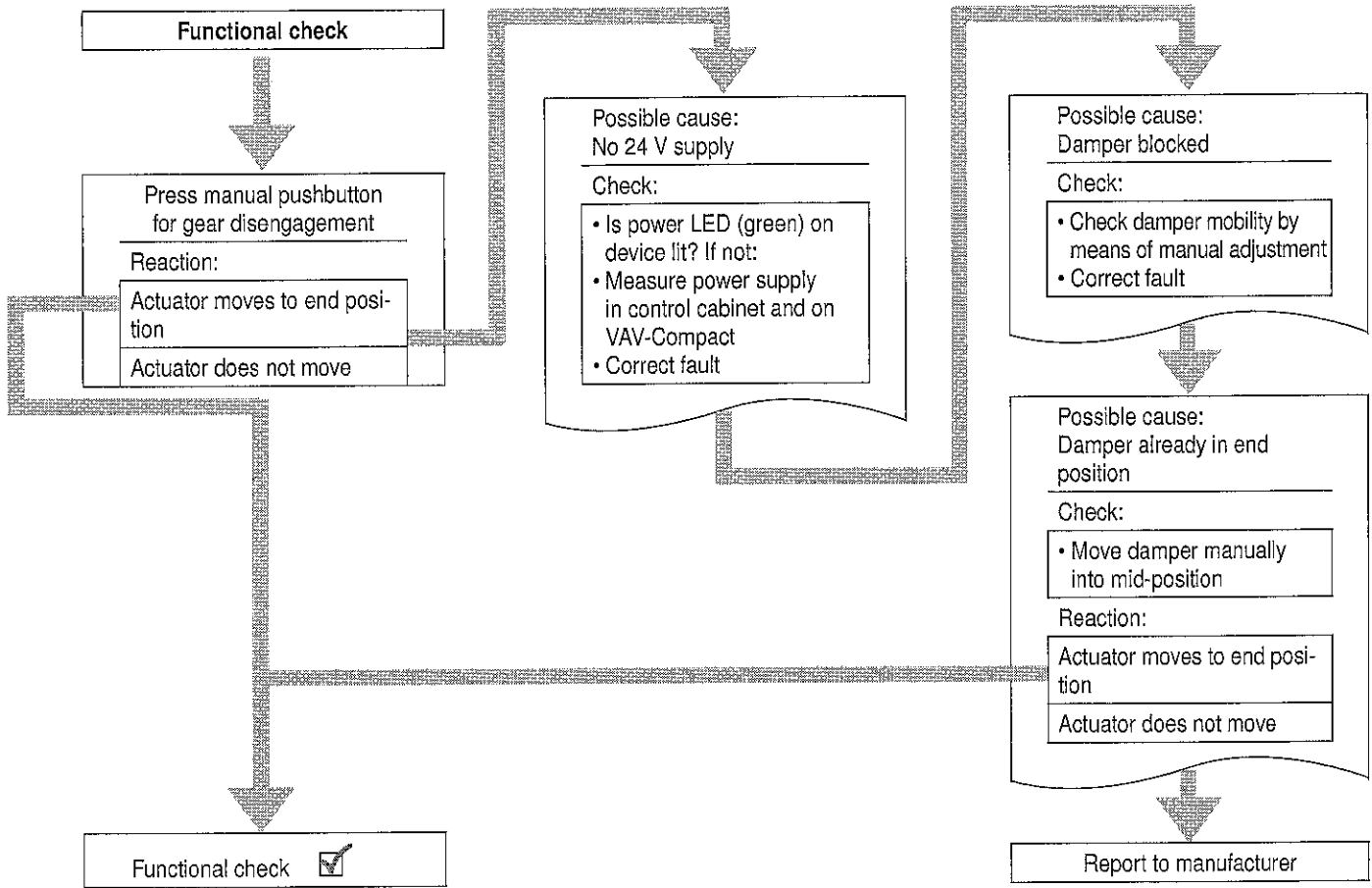

Table of contents

Functional check

Flow chart	2
Analysing faulty behaviour	2
Fault descriptions, symptoms, causes and rectification	3

Flow chart



Analysing faulty behaviour

Symptoms, causes and rectification

Various fault symptoms, their possible causes and recommended rectification steps are described below. Based on past experience, the faulty behaviour is probably due to the settings or control mode rather than to the air volume controller itself. A structured approach is essential to identify the most efficient remedy regardless of the particular malfunction:

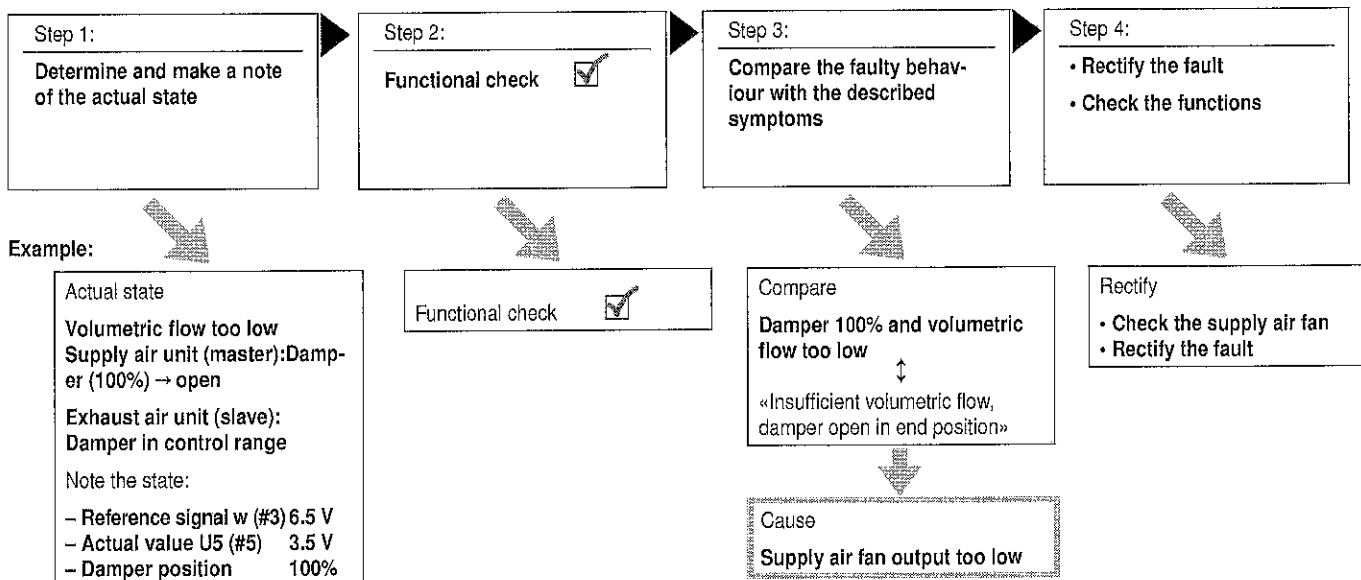

Fault descriptions, symptoms, causes and rectification

Insufficient volumetric flow, damper OPEN in end position

Symptom	Possible cause	Rectification steps
Set volume not reached although damper is 100% open (end stop)	Fan failure	Check the fan, including the control functions, and rectify the fault
	Fire dampers tripped, i.e. closed	Check whether all fire and/or shut-off dampers between the fan and the VAV unit are open
	Fan air output too low	Measure the air output and increase it if necessary, e.g. by increasing the setpoint of the frequency converter
	Some or all rooms are often set positively (manually) to maximum volumetric flow when the system is started up. Consequence: The fan is unable to produce the required air output (simultaneity factor)	Deactivate override control and/or reduce the reference signal

Insufficient volumetric flow, master damper OPEN / slave damper CLOSED

Symptom	Possible cause	Rectification steps
Set volume not reached: • Damper of master unit is open • Damper of slave unit is closed	VAV units in master/slave connection: • Master in air shortage situation (fan defective or OFF), i.e. damper is 100% open	Check the fan in the line of the master unit and rectify the fault
	• Slave does not receive reference signal from master because master does not measure actual volume → damper CLOSED	Check whether all fire and/or shut-off dampers between the fan and the master unit are open

No volumetric flow, damper CLOSED in end position

Symptom	Possible cause	Rectification steps
Set volume not reached and damper closed although reference signal is present	Current setpoint or \dot{V}_{\min} setting corresponds to differential pressure $< 2 \text{ Pa}$. Damper closed due to «creep flow suppression» function	Increase the \dot{V}_{\min} parameter Adjust the reference signal or correct the VAV-Compact mode setting
Damper closes (0%) instead of opening to \dot{V}_{\min} value	VAV-Compact set to 2...10 V mode but controlled with 0...10 V reference signal	Change the VAV-Compact mode setting to 0...10 V

Volumetric flow too high, damper OPEN

Symptom	Possible cause	Rectification steps
Actual volume too high, damper open at end stop	Pressure hose squeezed off (jammed)	Check the pressure hoses: – Mark the +/- connections – Pull the pressure hoses off of the VAV-Compact – Blow through the hose lines
	Sensor, pressure hose or pressure sensor contaminated Note: The differential pressure sensor of the VAV-Compact does not normally need to be cleaned	Check the parts and clean them if necessary: – Mark the +/- connections – Pull the pressure hoses off of the VAV-Compact – Clean and blow out the sensor – Blow through the hose lines – Blow out the pressure sensor on the VAV-Compact and connect the hand pump to the (minus) connection. Remove any visible dirt – Mount the pressure hoses – Carry out a functional check

Volumetric flow too low, damper in control range

Symptom	Possible cause	Rectification steps
Required volumetric flow not reached	Reference signal (DDC, room controller) limited by software	Check the reference signal (DDC, room controller) and adjust the limitation
	VAV-Compact set to 2...10 V mode but controlled with 0...10 V reference signal	Correct the VAV-Compact mode setting

Fault descriptions, symptoms, causes and rectification (continued)
Volumetric flow too high, damper in control range

Symptom	Possible cause	Rectification steps
Steady-state deviation of volumetric flow (too high) relative to reference signal	VAV-Compact set to 0...10 V mode but controlled with 2...10 V reference signal	Adjust the reference signal or correct the VAV-Compact mode setting

Positive/negative room pressure, damper in control range

Symptom	Possible cause	Rectification steps
Undesirable positive or negative pressure in room	Clamp loose, turns without spindle driver	Check the clamp mounting
	Room pressure ratio not set correctly	Check the operating volumetric flow setting
	Master/slave application with limited operating volumetric flow setting on slave controller	Check the operating volumetric flow setting. If the room pressure is balanced, the slave setting should be as follows: \dot{V}_{\min} 0% / \dot{V}_{\max} 100% (for an identical nominal width and air volume)
	Wiring incorrect, VAV units interchanged (master/slave or parallel connection) Example: Supply air office a and exhaust air office b Supply air office b and exhaust air office a VAV units set to master/slave but controlled in parallel	Check the wiring and correct it if necessary

Air volume controller does not react to reference signal

Symptom	Possible cause	Rectification steps
VAV controller adjusts to fixed value and does not react to reference signal changes	0/2...10 V reference signal has no reference, i.e. ground connection (GND) is missing	Measure the signal between VAV-Compact terminals 1 (GND) and 3 (0/2...10 V). Check the wiring and correct it if necessary
	Polarity of reference signal and ground (GND) reversed	Measure the signal between VAV-Compact terminals 1 (GND) and 3 (0/2...10 V). Check the wiring and correct it if necessary
	AC 24 V connection reversed. If several devices are connected to the same AC 24 V transformer, this connection must be in phase	Check the wiring and correct it if necessary
	Operating mode (override control) active	Check the controller

Damper does not move

Symptom	Possible cause	Rectification steps
Damper does not move	Clamp loose, turns without spindle driver	Check the clamp mounting